

iQ parts

when quality counts



www.iqparts.com

***Katalog
Catalog
Catalogue***

innovative Quality

Die Qualität der Originalteile ist unsere Mindestanforderung

Landwirte und Lohnunternehmer müssen gewinnorientiert arbeiten. Erträge sind wie überall abhängig vom materiellen Einsatz und von der Arbeitszeit. Somit wird der Erfolg nicht zuletzt von der Standzeit der Verschleißteile bestimmt. Hochwertigere Teile mit langer Lebensdauer sparen unnötige Arbeitszeit für oftmaligen Teilewechsel.

Deshalb ist unsere Basisqualität die Originalqualität der Hersteller. Alles darüber hinaus bedeutet ein Mehr an Lebensdauer und Einsparung an Arbeitszeit.

Original Quality is our minimum requirement

Nowadays farmers have to work profit-oriented. Revenues are as everywhere dependent on material input and life time. In this case farmers' success has a strong connection to life time of wearing parts. High quality parts with long life time reduce working time for often parts change.

That's why our standard quality is equal to the quality of OEMs. All this also means a longer life time and savings in working time. As your partner, we fulfill these requirements not only with the material.

iQparts

Doppelte Lebensdauer soll kein Glücksspiel sein

Twice the life span isn't supposed to be gambling.

Doppelte Lebensdauer

iQ-Parts hat in der Standardqualität mit 48 - 52 HRC oft mehr als die doppelte Lebensdauer als manche Originalteile (40 - 46 HRC)

Twice the life span

In the standard quality with 48 - 52 HRC, iQ-parts often has more than twice the life span of some original parts (40 - 46 HRC)



- 1 Mehr Verschleißmaterial – vielfache Lebensdauer**
More wearing material – long life time
- 2 160 % härter – weniger Verschleiß**
160% harder – less wear
- 3 25 % breiter – längere Lebensdauer**
25% wider – longer life time

EGGE UND KULTIVATOR

HARROW AND CULTIVATOR | HERSE ET CULTIVATEUR | БОРОНЫ И КУЛЬТИВАТОРЫ
RASTRAS Y CULTIVADORES | ERPICE E COLTIVATORE | KOMBINÁTOROK
BRONY I KULTYWATORY | TANJIRAČE I KULTIVATORI
BRANE IN KULTIVATORJI | GRAPE SI CULTIVATOARE

GRUBBER

CULTIVATOR | DÉCHAUMEUR | КУЛЬТИВАТОРЫ | GRADAS DE DISCOS
COLTIVATORE E ERPICE A DISCHI | SZÁNTÓFÖLDI KULTIVÁTOROK ÉS TÁRCSÁS BORONÁK
KULTYWATORY I BRONY TALERZOWE | KULTIVATORI I DISKOSNE TANJIRAČE
KULTIVATORJI IN KROŽNE BRANE | CULTIVATOARE SI GRAPE CU DISCURI

KREISELEGGE

POWER HARROW | HERSE ROTATIVE | ПОТАЦИОННЫЕ БОРОНЫ
GRADAS ROTATIVAS | ERPICE | FORGÓBORONÁK | BRONY AKTYWNE
ROTACIONE DRLJAČE | VRTAVKASTE BRANE | GRAPE ROTATIVE

BODENFRÄSE

ROTARY CULTIVATOR | FRAISE ETACTIL D'ENTRETIEN | ПОЧВЕННЫЕ ФРЕЗЫ
FRESADORAS | ERPICE ROTANTE | ÁSÓBORONÁK | GLEBOGRYZARKA
FREZE | FREZE ZA OBDELAVO TAL | FREZA ROTATIVA

PFLUG

PLOUGH | CHARRUE | ПЛУГИ
ARADOS | ARATRO | EKÉK | PŁUGI
PLUG | PLUGI | PLUGURI

SÄMASCHINE

SEED DRILL MACHINE | SEMOIR | СЕЯЛКИ
SEMBRADORA | SEMINATRICE | VETŐGÉP | SIEWNIK
SEJALICA | SEJALNICA | SEMANATORI

SCHEIBENEGGE

DISK HARROW | HERSES À DISQUES | ДИСКОВЫЕ БОРОНЫ
GRADA DE DISCOS | DISCO | RÖVID TÁRCSA | BRONA TALERZOWA
GRAPĂ CU DISCURI | DISKOVI | GRAPĂ CU DISCURI

SCHLEGELHÄCKSLER UND MULCHER

MULCHERS | DÉCHIQUETEUSES ET BROYEURS | ФРЕЗА И МУЛЬЧЕР
TRITURADORAS O PICADORAS | TRINCIATURA A MARTELLI E TRINCIA | MULCSOZÓ
ROZDRABNIACZE I MULCZERY | MALČER | MALČER | TOCĂTOARE ŞI MULCHER

SCHRAUBEN

SCREW | VIS | БОЛТЫ
TORNILLOS | BULLONERIA | CSAVAROK | ŚRUBY
VIJCI | VIJAKI | SURUBURI



Ihr Kompetenzzentrum in Sachen Verschleißteile

*Your competence center
in terms of wearing parts*

*Votre centre de compétence
en termes de pièces d'usure*

*Ваш центр компетенции в части
изнашиваемых деталей*



HAUPTSITZ | HEAD OFFICE | SIÈGE PRINCIPAL | ГЛАВНЫЙ ОФИС

Beyne GmbH

Bundesstraße 8 | A – 8661 St. Barbara im Mürztal | Austria

GESCHÄFTSZEITEN | BUSINESSHOURS | HEURES D'OUVERTURE | РАБОЧИЕ ЧАСЫ

Montag - Donnerstag: | Monday - Thursday:

Lundi - Jeudi: | Понедельник - Четверг

8.00 - 12.00 & 13.30 - 16.00

Freitag: | Friday: | Vendredi | Пятница

8.00 - 12.30

KONTAKT | CONTACT | CONTACT | КОНТАКТ

AUFTRAGSABWICKLUNG | ORDER PROCESSING

ADMINISTRATION DES VENTES | ОТДЕЛ ЗАКАЗОВ

Tel.: +43 3858 / 6055 -0

Fax: +43 3858 / 6055 – 409

E-Mail: order@iqparts.com

BUCHHALTUNG | ACCOUNTING

COMPTABILITÉ | БУХГАЛТЕРИЯ

Tel.: +43 3858 / 6055 - 0

Fax: +43 3858 / 6055 - 409

E-Mail: accounting@iqparts.com

BANKDATEN | BANK DATA | BANQUE DE DONNEES | БАНКОВСКИЕ ДАННЫЕ

Beyne GmbH

Volksbank Steiermark AG

Kto.-Nr.: 14395450000

BIC: VBOEATWWGRA

IBAN: AT574477014395450000

KONDITIONEN | CONDITIONS | CONDITIONS GÉNÉRALES | УСЛОВИЯ

Es gelten unsere Allgemeinen Geschäftsbedingungen, die Sie unter www.iqparts.com einsehen können.

We refer to our General Terms and Conditions which can be viewed at any time under www.iqparts.com.

Vous trouverez nos conditions générales de vente et de livraison sur www.iqparts.com. Merci d'en prendre note.

Применяются наши общие положения и условия, которые Вы можете увидеть на нашем сайте www.iqparts.com.

www.iqparts.com

QUALITY LEVELS

iQparts



iQparts iQ-Diamond

Die High-end-Lösung von iQparts - Verschleißteile mit aufgepanzertem Hartmetall-Tungsten Carbide.
HV 1100

The high-end solution from iQparts -wearing parts with tungsten carbide hardfacing.
HV 1100



iQparts iQ-Hardface

In der bewährten aufgepanzerten Qualität.
HV 800, HRC 64

Proven quality hardfacing.
HV 800, HRC 64



iQparts iQ-Plus

Jeweils um eine Materialstärke stärker als das Original.
HV 500 - 550, HRC 48 - 52







Every time the material thickness becomes stronger than the Original part. HV 500 - 550, HRC 48 - 52



iQparts Original

Die gehärtete Standardqualität von iQparts - das perfekte Ausgangsprodukt für alle Aufpanzerungen.
HV 500 - 550, HRC 48 - 52

Exceptional hardness as standard from iQparts - the perfect base product for all hardfacings.
HV 500 - 550, HRC 48 - 52

| PACKLISTE | | Kunde: Customer/Client: | | | | | | |
|---------------------|-----|-----------------------------------|-----------|----------|-------|------|--------|---|
| PACKING LIST | | Beyne GmbH - IQ-PARTS | | | | | | |
| | | Bundesstrasse 8 | | | | | | |
| | | 8661 St. Barbara/Austria | | | | | | |
| 100XXXX/1 | | | | | | | | |
| Stück | Pc. | Bezeichnung | Part-Name | Artikel- | Part- | Logo | Colour | |
| 1 | | EUROPALETTE 1200X800X100 | | 63581 | | | |  5 |
| 47 | | ANLAGE 2701 1400 LG 1 | WP292-0 | CR000090 | | IQ | BLAU |  |
| 50 | | SCHARBLATT LEMKEN LINKS 335 2121 | | CL100076 | | IQ | BLAU |  |
| 50 | | SCHARBLATT LEMKEN RECHTS 335 2120 | | CL100075 | | IQ | BLAU |  |
| 500 | | SENKSCHRB. DIN608-12,9 M12x35 | | 548000V | | IQ | ROH |  |
| 500 | | SENKSCHRAUBE M10X30 DIN609-12.9 | | 547900V | | IQ | ROH |  |

1. ORIGINAL NUMBER
2. IQ PARTS NUMBER
3. LOGO
4. COLOUR
5. BAR CODE (CUSTROMER SPECIFIC NO.)
6. CUSTROMER SPECIFIC NUMBER



LIEFERSCHEIN Blatt 1

AB-NUMMER DATUM KUNDENUMMER
20190XXX 05.04.19 2001010

LIEFERSCHEINNUMMER LIEFERDATUM
20190XXXX 09.04.2019

SACHBEARBEITER/VERTRIEBSMITARBEITER
JOSIPA JURICEVIC/-KEIN VERTRIEBSMITA

VERSANDART
AB WERK

BESTELLUNG:
WEB XXX; WEB XXX.

| POS | GEGENSTAND | MENGE | ME | ARTIKEL-NUMMER |
|-----|-------------------------------|-------|----|----------------|
| 1 | ANLAGE WP 292 LINKS/RECHTS | 47,00 | ST | CR000090 |
| | 2701 1400 | | | 234.567 |
| | BLAU | | IQ | 345.678 |
| 2 | SCHARBLATT 335 LINKS | 50,00 | ST | CL100076 |
| | 335 2121 | | | 345.678 |
| | BLAU | | IQ | |

EGGE UND KULTIVATOR

HARROW AND CULTIVATOR

HERSE ET CULTIVATEUR

БОРОНЫ И КУЛЬТИВАТОРЫ

RASTRAS Y CULTIVADORES

ERPICE E COLTIVATORE

KOMBINÁTOROK

BRONY I KULTYWATORY

TANJIRAČE I KULTIVATORI

BRANE IN KULTIVATORJI

GRAPE SI CULTIVATOARE



Spring Tines
Dents élastiques
Palec sprężysty
Зуб пружинный
Rugós Kara
Púa S
S-opruga
Vzmetni krak
Dente S
arc

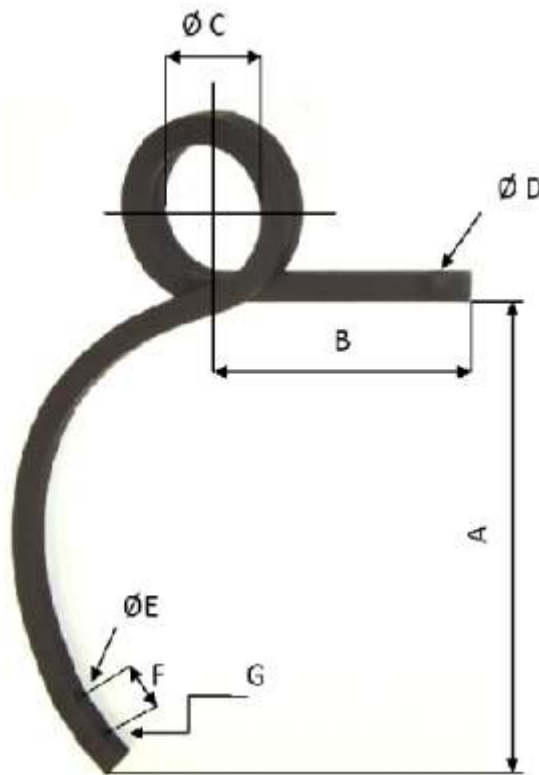

[mm]

| ITEM NO. | Q | right | left | A | B | ØC | ØD | ØE | F | G | Interchangeable to |
|----------|-------|-------|------|-----|-----|-----|----|----|----|-------|--------------------|
| CU100009 | 25X25 | X | | 455 | 240 | 120 | 13 | 13 | 45 | R 300 | |
| CU100010 | 25X25 | | X | 455 | 240 | 120 | 13 | 13 | 45 | R 300 | |
| CU100011 | 30X30 | X | | 535 | 280 | 120 | 17 | 13 | 45 | R 300 | |
| CU100012 | 30X30 | | X | 535 | 280 | 120 | 17 | 13 | 45 | R 300 | |
| CU100013 | 35X35 | X | | 635 | 280 | 145 | 17 | 13 | 75 | R 300 | |
| CU100014 | 35X35 | | X | 635 | 280 | 145 | 17 | 13 | 75 | R 300 | |
| CU100015 | 40x40 | X | | 640 | 310 | 180 | 21 | 13 | 70 | R 300 | |
| CU100016 | 40x40 | | X | 640 | 310 | 180 | 21 | 13 | 70 | R 300 | |

| Federzinke S-Tine / Dent ressort | Interchangeable to |
|-------------------------------------|----------------------------|
| Item No. CU1 000 01 | Dimension 25 X 8 |

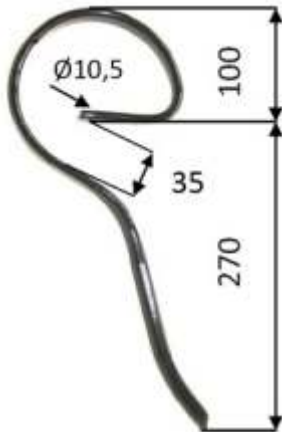

| Federzinke S-Tine / Dent ressort | Interchangeable to |
|-------------------------------------|----------------------------|
| Item No. CU1 000 02 | Dimension 25 X 8 |

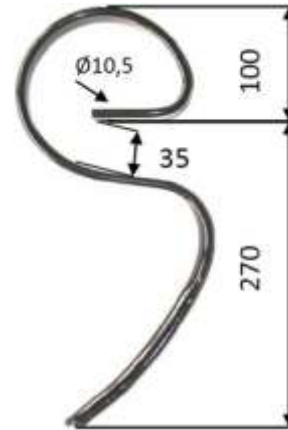

| Federzinke S-Tine / Dent ressort | Interchangeable to |
|-------------------------------------|-----------------------------|
| Item No. CU1 000 08 | Dimension 45 X 12 |

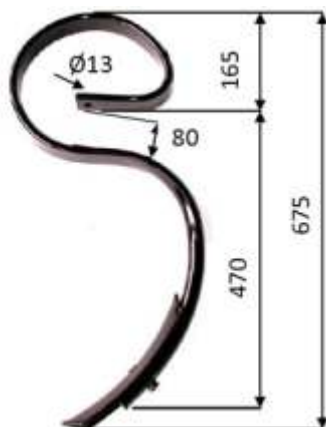

| Federzinke S-Tine / Dent ressort | Interchangeable to |
|-------------------------------------|-----------------------------|
| Item No. CU1 000 03 | Dimension 32 X 10 |

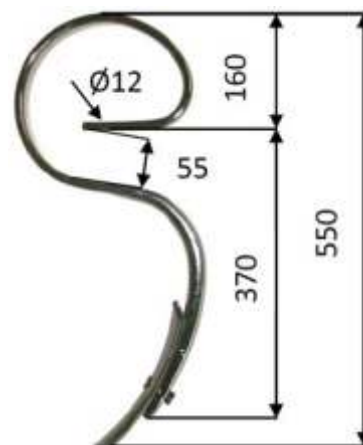

| Federzinke S-Tine / Dent ressort | Interchangeable to |
|-------------------------------------|-----------------------------|
| Item No. CU1 000 04 | Dimension 32 X 12 |

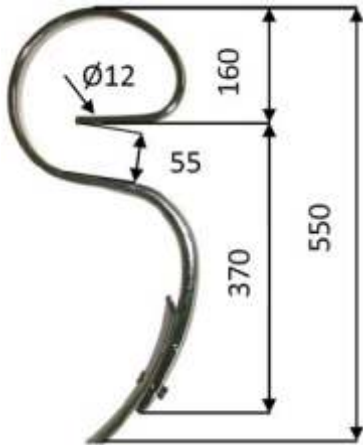

| Federzinke S-Tine / Dent ressort | Interchangeable to Väderstad „Agrilla Nova“ |
|-------------------------------------|--|
| Item No. CU1 000 05 | Dimension 45 X 10 |

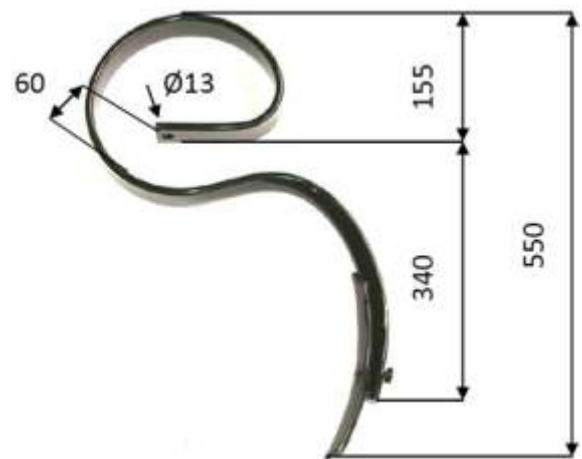

| Federzinke S-Tine / Dent ressort | Interchangeable to Väderstad „Agrilla Cobra“ |
|-------------------------------------|---|
| Item No. CU1 000 07 | Dimension 45 X 10 |

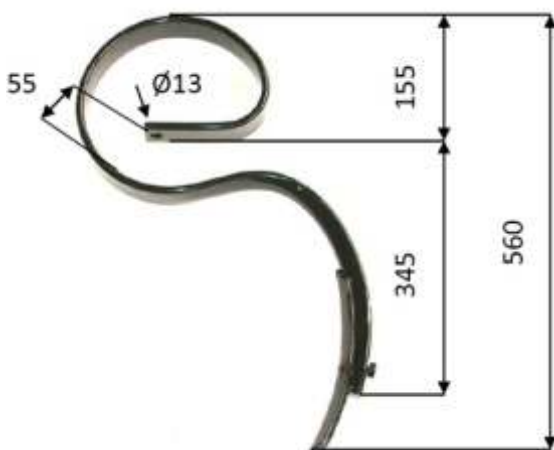

| Federzinke S-Tine / Dent ressort | Interchangeable to Väderstad „Agrilla Super“ |
|-------------------------------------|---|
| Item No. CU1 000 06 | Dimension 45 X 10 |

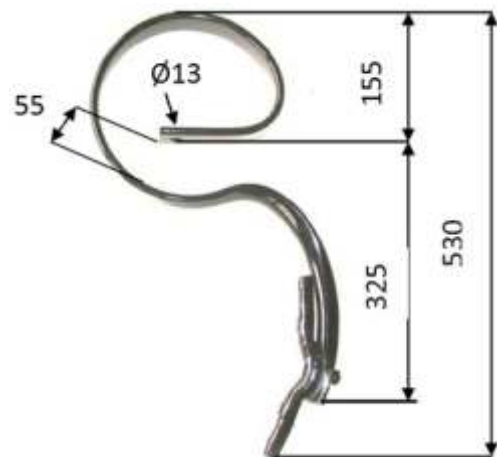

Teile passend zu
parts interchangeable
Pièces adaptables pour

Farmet

Gänsefußschar

Sweep / Socs Patte d'oie

CF1 000 06

3000236 270X6

| | | |
|--|-------------|-----------------------|
| | Unit weight | 0,92 |
| | color | ■ schwarz |
| | piece unit | 500 Pal |
| | accessories | 1 x B-1250 M12x50 DIN |



Teile passend zu
parts interchangeable
Pièces adaptables pour

Federzinken

Federzinke

S-Tine / Dent ressort

CU1 000 01

25x8x270

| | | |
|--|-------------|-----------|
| | Unit weight | 0,98 |
| | color | ■ schwarz |
| | piece unit | 250 Pal |
| | accessories | |



Federzinke

S-Tine / Dent ressort

CU1 000 02

25x8x270

| | | |
|--|-------------|-----------|
| | Unit weight | 1,00 |
| | color | ■ schwarz |
| | piece unit | 250 Pal |
| | accessories | |



Federzinke mit Schar

S-tine with share / Dent ressort avec soc

CU1 000 03

32x10x550

| | | |
|--|-------------|-----------|
| | Unit weight | 3,20 |
| | color | ■ schwarz |
| | piece unit | 250 Pal |
| | accessories | |



Federzinke mit Schar

S-tine with share / Dent ressort avec soc

CU1 000 04

32x12x550

| | | |
|--|-------------|-----------|
| | Unit weight | 3,50 |
| | color | ■ schwarz |
| | piece unit | 250 Pal |
| | accessories | |



Teile passend zu
parts interchangeable
Pièces adaptables pour

Federzinken

Federzinke mit Schar
S-tine with share / Dent ressort avec soc

CU1 000 06

45x10x530

| | | |
|--|-------------|-----------|
| | Unit weight | 4,06 |
| | color | ■ schwarz |
| | piece unit | 250 Pal |
| | accessories | |

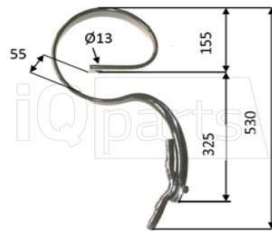

Federzinke mit Schar
S-tine with share / Dent ressort avec soc

CU1 000 05

45x10x550

| | | |
|--|-------------|-----------|
| | Unit weight | 3,98 |
| | color | ■ schwarz |
| | piece unit | 250 Pal |
| | accessories | |



Federzinke mit Schar
S-tine with share / Dent ressort avec soc

CU1 000 07

45x10x560

| | | |
|--|-------------|-----------|
| | Unit weight | 4,15 |
| | color | ■ schwarz |
| | piece unit | 250 Pal |
| | accessories | |



Federzinke mit Schar
S-tine with share / Dent ressort avec soc

CU1 000 08

45x12x675

| | | |
|--|-------------|-----------|
| | Unit weight | 5,50 |
| | color | ■ schwarz |
| | piece unit | 250 Pal |
| | accessories | |

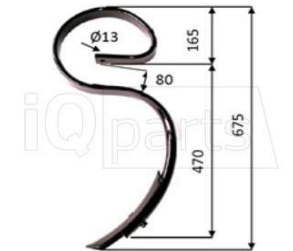

Teile passend zu
parts interchangeable
Pièces adaptables pour

KÖCKERLING

Gänsefußschar
Sweep / Socs Patte d'oise

CK4 100 19N

504019N 2-hole 300x52x10

| | | |
|--|-------------|-----------------------|
| | Unit weight | 1,30 |
| | color | ■ schwarz |
| | piece unit | 300 Pal |
| | accessories | 2 x Q-1060 M10x60-10. |



Gänsefußschar
Sweep / Socs Patte d'oise

CK4 100 19NH

504019NH 2-hole f. bolt Q-1060

| | | |
|--|-------------|-----------------------|
| | Unit weight | 1,40 |
| | color | ■ schwarz |
| | piece unit | 300 Pal |
| | accessories | 2 x Q-1060 M10x60-10. |



Teile passend zu
parts interchangeable
Pièces adaptables pour

Kultivatorschare

Gänsefußschar
Sweep / Socs Patte d'oise

CV0 001 22

150 mm x 4mm 23 Grad

| | | |
|--|-------------|-----------|
| | Unit weight | 0,50 |
| | color | ■ schwarz |
| | piece unit | 500 Pal |
| | accessories | |



Gänsefußschar
Sweep / Socs Patte d'oise

CV0 001 21

150mm x 4 - 50 Grad

| | | |
|--|-------------|-----------|
| | Unit weight | 0,50 |
| | color | ■ schwarz |
| | piece unit | 500 Pal |
| | accessories | |



Gänsefußschar
Sweep / Socs Patte d'oise

CV0 001 23

180mm x 4mm 50Grad

| | | |
|--|-------------|-----------|
| | Unit weight | 1,00 |
| | color | ■ schwarz |
| | piece unit | 500 Pal |
| | accessories | |



Gänsefußschar
Sweep / Socs Patte d'oise

CV0 001 54

190mm x 6mm

| | | |
|--|-------------|-----------------------|
| | Unit weight | 0,96 |
| | color | ■ schwarz |
| | piece unit | 500 Pal |
| | accessories | 2 x Q-1060 M10x60-10. |



Gänsefußschar
Sweep / Socs Patte d'oise

CV0 001 55

CV0 00155 190x6MM

| | | |
|--|-------------|-----------------------|
| | Unit weight | 0,96 |
| | color | ■ schwarz |
| | piece unit | 500 Pal |
| | accessories | 1 x Q-1060 M10x60-10. |



Gänsefußschar
Sweep / Socs Patte d'oise

CV0 001 56

CV0 00156 100 x 6mm

| | | |
|--|-------------|-----------------------|
| | Unit weight | 0,69 |
| | color | ■ schwarz |
| | piece unit | 500 Pal |
| | accessories | 1 x Q-1060 M10x60-10. |



Gänsefußschar
Sweep / Socs Patte d'oise

CV0 080 23

JD 100 100x6MM

| | | |
|--|-------------|-----------------------|
| | Unit weight | 0,85 |
| | color | ■ schwarz |
| | piece unit | 500 Pal |
| | accessories | 2 x B-1270 2700 2613, |



Gänsefußschar
Sweep / Socs Patte d'oise

CV0 080 16

JD 270 270x6MM

| | | |
|--|-------------|-----------------------|
| | Unit weight | 1,47 |
| | color | ■ schwarz |
| | piece unit | 500 Pal |
| | accessories | 2 x B-1270 2700 2613, |



Teile passend zu
parts interchangeable
Pièces adaptables pour

Kultivatorschare

Gänsefußschar
Sweep / Socs Patte d'oie

CV0 080 16V

JD270 x 8MM

| | | |
|--|-------------|-----------------------|
| | Unit weight | 2,00 |
| | color | roh |
| | piece unit | 500 Pal |
| | accessories | 2 x B-1270 2700 2613, |



Teile passend zu
parts interchangeable
Pièces adaptables pour

Spatenrollenmesser

Spatenrollenmesser
Rotating cultivator blades /

LINKS / LEFT / GAUCHE

RECHTS / RIGHT / DROITE

CV0 000 32

CV0 000 31

SRM 400 LI

SRM 400 RE

| | | |
|--|-------------|---------|
| | Unit weight | 2,10 |
| | color | schwarz |
| | piece unit | 500 Pal |
| | accessories | |



GRUBBER

CULTIVATOR

DÉCHAUMEUR

КУЛЬТИВАТОРЫ

GRADAS DE DISCOS

COLTIVATORE E ERPICE A DISCHI

SZÁNTÓFÖLDI KULTIVÁTOROK ÉS TÁRCSÁS BORONÁK

KULTYWATORY I BRONY TALERZOWE

KULTIVATORI I DISKOSNE TANJIRAČE

KULTIVATORJI IN KROŽNE BRANE

CULTIVATOARE SI GRAPE CU DISCURI

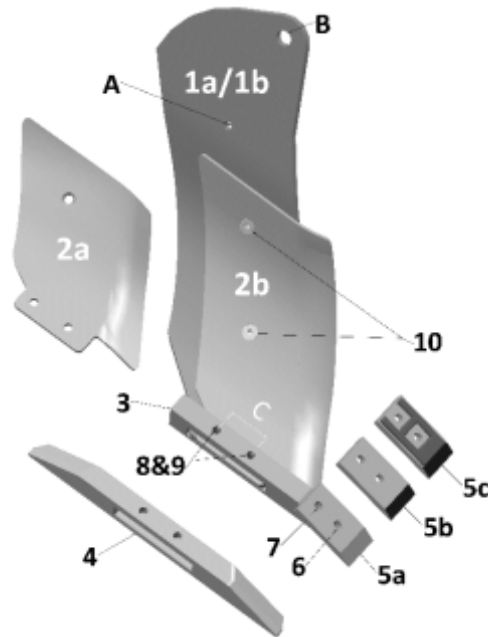

| UNIVERSAL – 950 mm | | | | Left | Right |
|--------------------|------------------|--------|--------|--------------------------|------------|
| 1a. | PLOUGH LEG | A=16mm | B=30mm | CS000117 | CS000116 |
| 1b. | PLOUGH LEG | A=30mm | B=30mm | CS000127 | CS000128 |
| 2a. | TRASH BOARD | | | CS000115 | CS000114 |
| 2b. | TRASHBOARD | | | CS000131 | CS000130 |
| 3. | SHARE | C=80mm | | CS000111 | CS000111 |
| 4. | SHARE REVERSIBLE | C=80mm | | CS000126 | CS000126 |
| 5a. | POINT | | | CS000112 | CS000112 |
| 5b. | POINT "D" | | | CS000112D | CS000112D |
| 5c. | POINT "DH" | | | CS000112DH | CS000112DH |
| 6. | M12 x 40 | | | 523732V | 523732V |
| 7. | M12 x 50 | | | 523732AV | 523732AV |
| 8. | SPRING PINS | | | GOU16000 - 16x60 DIN1481 | |
| 9. | SPRING PINS | | | 716600V - 10x60 DIN1481 | |
| 10. | SCREW M14x40 | | | VIS 14052 | |

| UNIVERSAL – 650 mm | | | | Left | Right |
|--------------------|------------------|--------|--------|-------------------------|------------|
| 1. | PLOUGH LEG | A=15mm | B=24mm | CS000119 | CS000118 |
| 2a. | TRASH BOARD | | | CS000124 | CS000123 |
| 3. | SHARE | C=85mm | | CS000125 | CS000125 |
| 4. | SHARE REVERSIBLE | C=85mm | | CS000129 | CS000129 |
| 5a. | POINT | | | CS000112 | CS000112 |
| 5b. | POINT "D" | | | CS000112D | CS000112D |
| 5c. | POINT "DH" | | | CS000112DH | CS000112DH |
| 6. | M12 x 40 | | | 523732V | 523732V |
| 7. | M12 x 50 | | | 523732AV | 523732AV |
| 8. | SPRING PINS | | | 715700V - 14x60 DIN1481 | |
| 9. | SPRING PINS | | | 715701V - 8x60 DIN1481 | |
| 10. | SCREW M14x40 | | | VIS 14052 | |

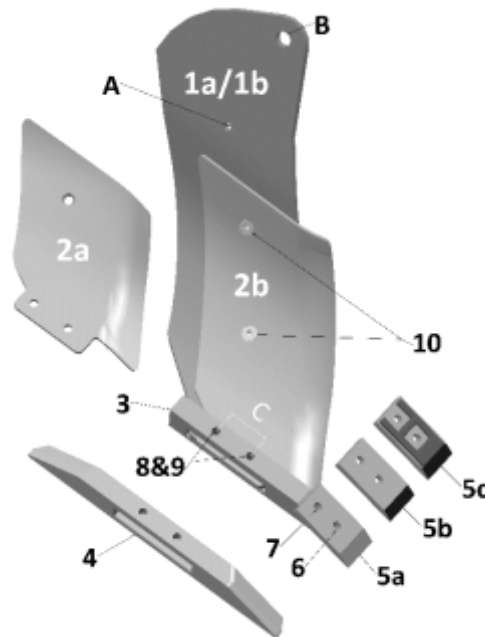

| VOGEL & NOOT | | | | Left | Right |
|--------------|--------------|--------|--------|--------------------------|-----------|
| 1a. | PLOUGH LEG | A=16mm | B=30mm | U1010001 | U1015001 |
| 2a. | TRASH BOARD | | | U1010003 | U1015003 |
| 3. | SHARE | C=80mm | | CS000121 | CS000121 |
| 5a. | POINT | | | CS000122 | CS000122 |
| 5b. | POINT "D" | | | CS000122D | CS000122D |
| 6. | M12 x 40 | | | LK000009V | LK000009V |
| 7. | M12 x 50 | | | LK000010V | LK000010V |
| 8. | SPRING PINS | | | GOU16000 - 16x60 DIN1481 | |
| 9. | SPRING PINS | | | 716600V - 10x60 DIN1481 | |
| 10. | SCREW M14x40 | | | VIS 14052 | |

| GREGOIRE BESSON HELIPLow | | | | Left | Right |
|--------------------------|------------------|--------|--------|--------------------------|--------------------|
| 1. | PLOUGH LEG | A=30mm | B=30mm | M302049 / CG100107 | M302048 / CG100106 |
| 2a. | TRASH BOARD | | | M310065 / CG100109 | M310064 / CG100108 |
| 3. | SHARE | C=85mm | | M320117 / CG100110 | M320117 / CG100110 |
| 4. | SHARE REVERSIBLE | C=85mm | | M320113 / CG100112 | M320113 / CG100112 |
| 5a. | POINT | | | M320118 / CS000112 | M320118 / CS000112 |
| 5b. | POINT "D" | | | CS000112D | CS000112D |
| 5c. | POINT "DH" | | | CS000112DH | CS000112DH |
| 6. | M12 x 40 | | | 523732V | 523732V |
| 7. | M12 x 50 | | | 523732AV | 523732AV |
| 8. | SPRING PINS | | | GOU16000 - 16x60 DIN1481 | |
| 9. | SPRING PINS | | | 716600V - 10x60 DIN1481 | |
| 10. | SCREW M14x40 | | | VIS 14052 | |

Cultivator Tines
Etancon Cultivateur
Стойка культиваторная
Púas de cultivador
Dente coltivateur
Kultivátor Kapatest
Ząb kultywatora
Kultivatorske motičice
Noži za predsetvenik
Gheara cultivator

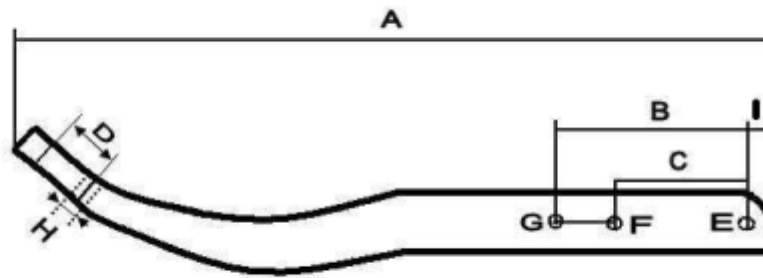

[mm]

| Artikel Nr. | Q | A | B | C | D | E | F | G | H | I |
|-------------|-------|-----|-----|-----|----|----|----|----|----|----|
| CV0045C2 | 60x25 | 720 | | 190 | 45 | 17 | 13 | | 13 | 20 |
| CV0045C1 | 60x25 | 720 | | 130 | 45 | 17 | 13 | | 13 | 20 |
| CV0045C3 | 60x25 | 720 | 190 | 130 | 45 | 17 | 13 | 13 | 13 | 20 |
| CV0045P1 | 60x25 | 720 | | 80 | 45 | 21 | 15 | | 13 | 50 |
| CV0045P2 | 60x25 | 720 | | 110 | 45 | 17 | 13 | | 13 | 20 |
| CV004504 | 60x25 | 720 | | | 45 | 17 | | | 13 | 20 |
| CV005009 | 60x25 | 850 | | 150 | 45 | 21 | 13 | | 13 | 23 |
| CV007004 | 60x25 | 720 | | 110 | 70 | 21 | 13 | | 13 | 15 |
| CV007001 | 60x25 | 720 | | 120 | 70 | 21 | 13 | | 13 | 20 |
| CV007002 | 60x25 | 720 | | | 70 | 17 | | | 13 | 20 |
| CV007006 | 60x25 | 720 | | | 70 | 17 | | | 13 | 50 |
| CV007008 | 60x25 | 850 | 195 | 180 | 70 | 21 | 13 | 13 | 13 | 25 |
| CV007502 | 60x25 | 720 | | 110 | 75 | 21 | 13 | | 13 | 20 |
| PD110001 | 60x25 | 720 | 127 | 110 | 70 | 21 | 13 | 13 | 13 | 15 |
| PD1100H1 | 60x25 | 720 | 127 | 110 | 70 | 21 | 15 | 15 | 13 | 15 |
| PD9500H1 | 60x25 | 820 | 127 | 110 | 70 | 21 | 15 | 15 | 13 | 15 |

Teile passend zu
parts interchangeable
Pièces adaptables pour

Agrisem

Verschleißstück - Streichblech - Vorderteil
Wearing part - Moulboard - Front part / Etrave

LINKS / LEFT / GAUCHE





CA1 000 04

BOR 20 - 132 hardface

RECHTS / RIGHT / DROITE

CA1 000 03

BOR 20 - 131 Hardface

| | | |
|---|-------------|-----------|
|  | Unit weight | 2,00 |
|  | color | ■ schwarz |
|  | piece unit | 500 Pal |
|  | accessories | |



Teile passend zu
parts interchangeable
Pièces adaptables pour





AMAZONE

Grubberschar

Cultivator Point / Soc double coeur

CA3 000 18

HC 119 400x60x16

| | |
|---|---|
|  Unit weight | 2,58 |
|  color |  schwarz |
|  piece unit | 250 Pal |
|  accessories | 2 x B-1280, 548305V |







Grubberschar

Cultivator Point / Soc double coeur

LINKS / LEFT / GAUCHE

CA3 000 22

HC 122/222 100x12

| | |
|---|--|
|  Unit weight | 3,35 |
|  color |  schwarz |
|  piece unit | 250 Pal |
|  accessories | 2 x B-1270 2700 2613, |



RECHTS / RIGHT / DROITE

CA3 000 21

HC 121/221 100x12





Grubberschar

Cultivator Point / Soc double coeur

LINKS / LEFT / GAUCHE

CA3 000 17H

HC 122H / 221H 75x12

| | |
|---|---|
|  Unit weight | 3,50 |
|  color |  schwarz |
|  piece unit | 250 Pal |
|  accessories | 250 x B-1270 2700 261 |



RECHTS / RIGHT / DROITE

CA3 000 16H

HC 121H / 221H 75x12





Grubberschar

Cultivator Point / Soc double coeur

LINKS / LEFT / GAUCHE

CA3 000 17

HC 221 / 222 75x12

| | |
|---|--|
|  Unit weight | 3,20 |
|  color |  schwarz |
|  piece unit | 250 Pal |
|  accessories | 2 x B-1270 2700 2613, |



RECHTS / RIGHT / DROITE

CA3 000 16





HC 121 / 221 75x12

Leitblech

Trashboard / Déflecteur

CL1 001 32

XL 015 100x8

| | |
|---|--|
|  Unit weight | 1,78 |
|  color |  blau |
|  piece unit | 500 Pal |
|  accessories | 1 x B-1280, 548305V |







Leitblech

Trashboard / Déflecteur

LINKS / LEFT / GAUCHE

CL1 001 44

XL 017

| | |
|---|---|
|  Unit weight | 2,45 |
|  color |  blau |
|  piece unit | 400 Pal |
|  accessories | 1 x B-1280, 548305V |



RECHTS / RIGHT / DROITE

CL1 001 43





XL 016

Scharfuß

Holder / Contre Sep

CL1 001 49

XL 021 (10MM)

| | |
|---|--|
|  Unit weight | 2,75 |
|  color |  blau |
|  piece unit | 300 Pal |
|  accessories | 1 x B-1260, 548250V |







Scharspitze

Share point / Nez de Soc

CA3 000 10H

XL 049 3374392C 120x12

| | |
|---|--|
|  Unit weight | 2,23 |
|  color |  schwarz |
|  piece unit | 500 Pal |
|  accessories | 1 x B-1235 - 3015785, 5 |





Teile passend zu
parts interchangeable
Pièces adaptables pour

BEDNAR

Grubberschar
Cultivator Point / Soc double coeur

CS2 000 01

KM060171 - 35





| | |
|---|---|
|  Unit weight | 5,50 |
|  color |  schwarz |
|  piece unit | 150 Pal |
|  accessories | |



Grubberschar
Cultivator Point / Soc double coeur

CS2 000 03

KM060197 - 30





| | |
|---|--|
|  Unit weight | 5,50 |
|  color |  schwarz |
|  piece unit | 150 Pal |
|  accessories | |



Grubberschar
Cultivator Point / Soc double coeur

CS2 000 04

KM060231 40x20



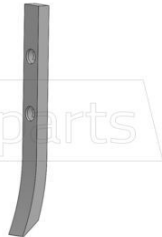

| | |
|---|---|
|  Unit weight | 2,37 |
|  color |  schwarz |
|  piece unit | 400 Pal |
|  accessories | |



Grubberschar
Cultivator Point / Soc double coeur

CS2 000 01H

KM060246 - 35 MM





| | |
|---|--|
|  Unit weight | 5,70 |
|  color |  schwarz |
|  piece unit | 150 Pal |
|  accessories | |



Grubberschar
Cultivator Point / Soc double coeur

CS2 000 03H

KM060247 - 30 MM





| | |
|---|---|
|  Unit weight | 5,70 |
|  color |  schwarz |
|  piece unit | 150 Pal |
|  accessories | |



Grubberschar
Cultivator Point / Soc double coeur

CS2 000 04DH

KM060248 40x20





| | |
|---|--|
|  Unit weight | 2,60 |
|  color |  schwarz |
|  piece unit | 400 Pal |
|  accessories | |



Grubberschar
Cultivator Point / Soc double coeur

CS2 000 01DH

KM060291 - 35 MM





| | |
|---|---|
|  Unit weight | 6,05 |
|  color |  schwarz |
|  piece unit | 150 Pal |
|  accessories | |



Grubberschar
Cultivator Point / Soc double coeur

CS2 000 03DH

KM060292 - 30 MM

| | |
|---|--|
|  Unit weight | 6,05 |
|  color |  schwarz |
|  piece unit | 150 Pal |
|  accessories | |



Teile passend zu
parts interchangeable
Pièces adaptables pour

BEDNAR

Grubberschar

Cultivator Point / Soc double coeur

CS2 000 15DH

KM60248 40x25 Diamant Hardfac

| | | |
|--|-------------|-----------|
| | Unit weight | 2,60 |
| | color | ■ schwarz |
| | piece unit | |
| | accessories | |



Grubberstiel

Cultivator Tines / Etancon Cultivateur

CS2 000 02

KM060226

| | | |
|--|-------------|-----------|
| | Unit weight | 11,50 |
| | color | ■ schwarz |
| | piece unit | 100 Pal |
| | accessories | |



Leitblech

Trashboard / Déflecteur

LINKS / LEFT / GAUCHE

CS2 000 11

KM060253 - 80mm

| | | |
|--|-------------|---------------------|
| | Unit weight | 1,70 |
| | color | ■ schwarz |
| | piece unit | 500 Pal |
| | accessories | 2 x B-1280, 548305V |

RECHTS / RIGHT / DROITE

CS2 000 10

KM060252 - 80mm



Leitblech

Trashboard / Déflecteur

LINKS / LEFT / GAUCHE

CS2 000 09

KM060258 - 60mm

| | | |
|--|-------------|---------------------|
| | Unit weight | 1,28 |
| | color | ■ schwarz |
| | piece unit | 500 Pal |
| | accessories | 2 x B-1280, 548305V |

RECHTS / RIGHT / DROITE

CS2 000 08

KM060257 - 60mm



Scharspitze

Share point / Nez de Soc

CS2 000 05

KM060177 60x12

| | | |
|--|-------------|---------------------|
| | Unit weight | 1,40 |
| | color | ■ schwarz |
| | piece unit | 500 Pal |
| | accessories | 1 x B-1285, 548307V |



Scharspitze

Share point / Nez de Soc

CS2 000 07

KM060179 100x12

| | | |
|--|-------------|---------------------|
| | Unit weight | 2,20 |
| | color | ■ schwarz |
| | piece unit | 400 Pal |
| | accessories | 1 x B-1285, 548307V |

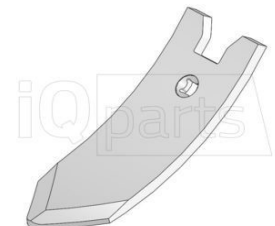

Scharspitze

Share point / Nez de Soc

CS2 000 06

KM060227 80x12

| | | |
|--|-------------|---------------------|
| | Unit weight | 1,80 |
| | color | ■ schwarz |
| | piece unit | 500 Pal |
| | accessories | 1 x B-1285, 548307V |

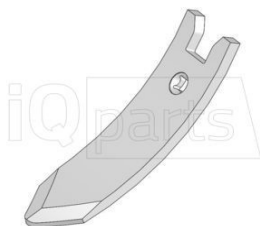

Scharspitze

Share point / Nez de Soc

CS2 000 12D

KM060249 - 80x15

| | | |
|--|-------------|---------------------|
| | Unit weight | 2,19 |
| | color | ■ schwarz |
| | piece unit | 400 Pal |
| | accessories | 1 x B-1285, 548307V |







Teile passend zu
parts interchangeable
Pièces adaptables pour

BEDNAR

Scharspitze
Share point / Nez de Soc

CS2 000 13D

KM060289 - 60x15





| | |
|---|---|
|  Unit weight | 1,70 |
|  color | ■ schwarz |
|  piece unit | 500 Pal |
|  accessories | 1 x B-1285, 548307V |



Scharspitze
Share point / Nez de Soc

CHO 000 50X

KM060334 2-hole 80x20 CP

| | |
|---|---|
|  Unit weight | 1,90 |
|  color | ■ schwarz |
|  piece unit | 300 Pal |
|  accessories | 1 x B-1285, 548307V 1 x B-1290, 548310V |







Teile passend zu
parts interchangeable
Pièces adaptables pour

DAL-BO

Grubberschar
Cultivator Point / Soc double coeur

CD2 000 02

76261 (120x10x450 LA80)





| | |
|---|---|
|  Unit weight | 3,70 |
|  color | ■ schwarz |
|  piece unit | |
|  accessories | |



Grubberschar
Cultivator Point / Soc double coeur

CD2 000 01

AF4922 120x10x420 LA75

| | |
|---|---|
|  Unit weight | 3,70 |
|  color | ■ schwarz |
|  piece unit | 250 Pal |
|  accessories | 2 x B-1270 2700 2613, |



Teile passend zu
parts interchangeable
Pièces adaptables pour

EINBÖCK

Flügelschare

Winged share / Ailette de Dechaumeur

LINKS / LEFT / GAUCHE





CE3 000 05

15-217

RECHTS / RIGHT / DROITE

CE3 000 04

15-216

| | |
|---|---|
|  Unit weight | 1,18 |
|  color |  schwarz |
|  piece unit | |
|  accessories | |







Gänsefußschar

Sweep / Socs Patte d'oie

CV0 001 55

15-166 190x6MM

| | |
|---|--|
|  Unit weight | 0,96 |
|  color |  schwarz |
|  piece unit | 500 Pal |
|  accessories | 1 x Q-1060 M10x60-10. |







Gänsefußschar

Sweep / Socs Patte d'oie

CV0 001 54

15-179 190x6MM

| | |
|---|---|
|  Unit weight | 0,96 |
|  color |  schwarz |
|  piece unit | 500 Pal |
|  accessories | 2 x Q-1060 M10x60-10. |







Gänsefußschar

Sweep / Socs Patte d'oie

CV0 001 56

15-223 100x6MM

| | |
|---|--|
|  Unit weight | 0,69 |
|  color |  schwarz |
|  piece unit | 500 Pal |
|  accessories | 1 x Q-1060 M10x60-10. |



Teile passend zu
parts interchangeable
Pièces adaptables pour

Farmet

Flügelschare

Winged share / Ailette de Dechaumeur

LINKS / LEFT / GAUCHE





CVO 090 08S

240 16 234 10 mm

RECHTS / RIGHT / DROITE

CVO 090 07S

240 16 134 10 mm

| | |
|---|-------------------------|
|  Unit weight | 2,10 |
|  color | ■ schwarz |
|  piece unit | 500 Pal |
|  accessories | 2 x B-1235 - 3015785, 5 |







Gänsefußschar

Sweep / Socs Patte d'oise

CF1 000 06

3000236 270x6

| | |
|---|-----------------------|
|  Unit weight | 0,92 |
|  color | ■ schwarz |
|  piece unit | 500 Pal |
|  accessories | 1 x B-1250 M12x50 DIN |







Scharspitze

Share point / Nez de Soc

CF1 000 07

3002317 75x12

| | |
|---|---------------------|
|  Unit weight | 2,20 |
|  color | ■ schwarz |
|  piece unit | 400 Pal |
|  accessories | 1 x B-1285, 548307V |







Scharspitze

Share point / Nez de Soc

CF1 000 05D

400 4483 75x15 Diamant

| | |
|---|---------------------|
|  Unit weight | 1,90 |
|  color | ■ schwarz |
|  piece unit | 500 Pal |
|  accessories | 1 x B-1285, 548307V |

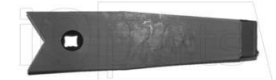





Scharspitze

Share point / Nez de Soc

CF1 000 05D

400 5271 75x15 Diamant

| | |
|---|---------------------|
|  Unit weight | 1,90 |
|  color | ■ schwarz |
|  piece unit | 500 Pal |
|  accessories | 1 x B-1285, 548307V |



Teile passend zu
parts interchangeable
Pièces adaptables pour

Federzinken

Federzinke

S-Tine / Dent ressort

LINKS / LEFT / GAUCHE

CU1 000 10

25x25x455

RECHTS / RIGHT / DROITE

CU1 000 09

25x25x455

| | | |
|--|-------------|---------|
| | Unit weight | 8,20 |
| | color | |
| | piece unit | 250 Pal |
| | accessories | |



Federzinke

S-Tine / Dent ressort

LINKS / LEFT / GAUCHE

CU1 000 16

40x40x640

RECHTS / RIGHT / DROITE

CU1 000 15

G3147001 40x40x640

| | | |
|--|-------------|---------|
| | Unit weight | 30,50 |
| | color | |
| | piece unit | 250 Pal |
| | accessories | |

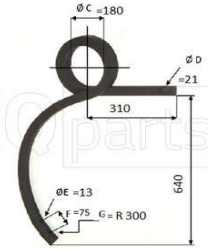

Vierkantzinken

Tine leg /

LINKS / LEFT / GAUCHE

CU1 000 12

30x30x535

RECHTS / RIGHT / DROITE

CU1 000 11

30x30x535

| | | |
|--|-------------|-------|
| | Unit weight | 12,50 |
| | color | |
| | piece unit | |
| | accessories | |



Vierkantzinken

Tine leg /

LINKS / LEFT / GAUCHE

CU1 000 14

35x35x635

RECHTS / RIGHT / DROITE

CU1 000 13

35x35x635

| | | |
|--|-------------|-------|
| | Unit weight | 20,20 |
| | color | |
| | piece unit | |
| | accessories | |



Teile passend zu
parts interchangeable
Pièces adaptables pour

FROST

Flügelschare

Winged share / Ailette de Dechaumeur

LINKS / LEFT / GAUCHE

CV2 000 04

51543 .

RECHTS / RIGHT / DROITE

CV2 000 03

51542 .

| | | |
|--|-------------|---------------------|
| | Unit weight | 1,85 |
| | color | ■ schwarz |
| | piece unit | 400 Pal |
| | accessories | 2 x G-1234, 523998V |



Teile passend zu
parts interchangeable
Pièces adaptables pour

Gregoire Besson

Grindel

Leg / Âge

LINKS / LEFT / GAUCHE

CG1 001 07

M302 049

Unit weight 24,50

color schwarz

piece 30
 unit Pal

accessories



Leitblech

Trashboard / Déflecteur

LINKS / LEFT / GAUCHE

CG1 001 09

M310 065

Unit weight 5,00

color schwarz

piece 200
 unit Pal

accessories 1 x C-1435, 546101V



RECHTS / RIGHT / DROITE

CG1 001 06

M302 048

RECHTS / RIGHT / DROITE

CG1 001 08

M310 064

Meissel - Wechselspitze

Reversible Point / Pointe Reversible

CS0 001 12

M320118

Unit weight 1,42

color schwarz

piece 500
 unit Pal

accessories 1 x G-1240, 523732V
1 x G-1250, 523732AV

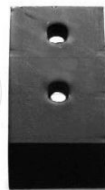

Meissel - Wechselspitze

Reversible Point / Pointe Reversible

CS0 001 12D

EINSEITIG CS000112D

Unit weight 1,50

color schwarz

piece 500
 unit Pal

accessories 1 x G-1240, 523732V
1 x G-1250, 523732AV



Meissel - Wechselspitze

Reversible Point / Pointe Reversible

CS0 001 12DH

M320118 Diamant Hardface

Unit weight 1,60

color schwarz

piece
 unit

accessories 1 x G-1250, 523732AV
1 x G-1240, 523732V



Meissel - Wechselspitze

Reversible Point / Pointe Reversible

CS0 001 12H

M320118 Hardface

Unit weight 1,42

color schwarz

piece 500
 unit Pal

accessories 1 x G-1240, 523732V
1 x G-1250, 523732AV



Schare

Share / Soc

CG1 001 12

M320113 reversible

Unit weight 7,50

color schwarz

piece 100
 unit Pal

accessories 2 x S-1660 16x60 DIN1+
2 x S-1060 10x 60DIN1+



Schare

Share / Soc

CG1 001 10

M320 117

Unit weight 4,98

color schwarz

piece 150
 unit Pal

accessories 2 x S-1060 10x 60DIN1+
2 x S-1660 16x60 DIN1+



Teile passend zu
parts interchangeable
Pièces adaptables pour

Horsch

Flügelschare

Winged share / Ailette de Dechaumeur

LINKS / LEFT / GAUCHE





CHO 000 15D

0031 0985 195mm Diamant

RECHTS / RIGHT / DROITE

CHO 000 16D

0031 0986 195mm Diamant

| | |
|---|---|
|  Unit weight | 2,15 |
|  color |  schwarz |
|  piece unit | 300 Pal |
|  accessories | 2 x K-1260 DIN 931-12.5 |



Flügelschare

Winged share / Ailette de Dechaumeur

LINKS / LEFT / GAUCHE





CHO 000 13D

0031 1180 175mm Diamant

RECHTS / RIGHT / DROITE

CHO 000 14D

0031 1181 175mm Diamant

| | |
|---|--|
|  Unit weight | 1,85 |
|  color |  schwarz |
|  piece unit | 300 Pal |
|  accessories | 2 x K-1260 DIN 931-12.5 |



Flügelschare

Winged share / Ailette de Dechaumeur

LINKS / LEFT / GAUCHE





CHO 000 55

0031 1328 10x193 4-Loch

RECHTS / RIGHT / DROITE

CHO 000 56

0031 1329 10x193 4-Loch

| | |
|---|---|
|  Unit weight | 2,08 |
|  color |  schwarz |
|  piece unit | 300 Pal |
|  accessories | 2 x K-1260 DIN 931-12.5 |

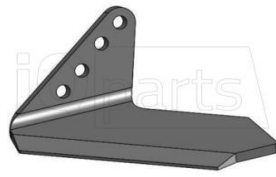

Flügelschare

Winged share / Ailette de Dechaumeur

LINKS / LEFT / GAUCHE





CHO 000 55H

0031 1328 10x193 4-Loch

RECHTS / RIGHT / DROITE

CHO 000 56H

0031 1329 10x193 4-Loch

| | |
|---|--|
|  Unit weight | 2,18 |
|  color |  schwarz |
|  piece unit | 300 Pal |
|  accessories | 2 x K-1260 DIN 931-12.5 |



Flügelschare

Winged share / Ailette de Dechaumeur

LINKS / LEFT / GAUCHE





CHO 000 55D

00311274 4-Loch breit

RECHTS / RIGHT / DROITE

CHO 000 56D

00311275 4-Loch breit

| | |
|---|---|
|  Unit weight | |
|  color |  schwarz |
|  piece unit | 300 Pal |
|  accessories | 2 x K-1260 DIN 931-12.5 |

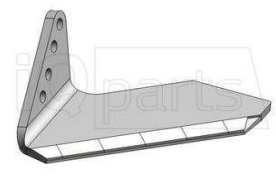

Flügelschare

Winged share / Ailette de Dechaumeur

LINKS / LEFT / GAUCHE





CHO 000 24

340 60854 115mm short

RECHTS / RIGHT / DROITE

CHO 000 23

340 60855 115mm short

| | |
|---|--|
|  Unit weight | 1,50 |
|  color |  schwarz |
|  piece unit | 300 Pal |
|  accessories | 2 x K-1260 DIN 931-12.5 |



Flügelschare

Winged share / Ailette de Dechaumeur

LINKS / LEFT / GAUCHE





CHO 000 13

340 60854 175mm

RECHTS / RIGHT / DROITE

CHO 000 14

340 60855 175mm

| | |
|---|---|
|  Unit weight | 1,85 |
|  color |  schwarz |
|  piece unit | 300 Pal |
|  accessories | 2 x K-1260 DIN 931-12.5 |



Flügelschare

Winged share / Ailette de Dechaumeur

LINKS / LEFT / GAUCHE





CHO 000 15

340 60856 195mm

RECHTS / RIGHT / DROITE

CHO 000 16

340 60857 195mm

| | |
|---|--|
|  Unit weight | 1,99 |
|  color |  schwarz |
|  piece unit | 300 Pal |
|  accessories | 2 x K-1260 DIN 931-12.5 |



Teile passend zu
parts interchangeable
Pièces adaptables pour

Horsch

Flügelschare

Winged share / Ailette de Dechaumeur

LINKS / LEFT / GAUCHE





CHO 000 15H

340 60856 hardface 195mm

RECHTS / RIGHT / DROITE

CHO 000 16H

340 60857 hardface 195mm

| | |
|---|---|
|  Unit weight | 2,05 |
|  color |  schwarz |
|  piece unit | 300 Pal |
|  accessories | 2 x K-1260 DIN 931-12.5 |



Flügelschare

Winged share / Ailette de Dechaumeur

LINKS / LEFT / GAUCHE





CHO 000 15D

340 60856D 195mm Diamant

RECHTS / RIGHT / DROITE

CHO 000 16D

340 60857D 195mm Diamant

| | |
|---|--|
|  Unit weight | 2,15 |
|  color |  schwarz |
|  piece unit | 300 Pal |
|  accessories | 2 x K-1260 DIN 931-12.5 |

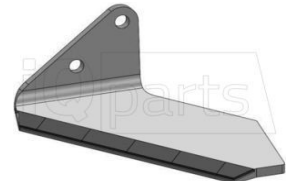

Flügelschare

Winged share / Ailette de Dechaumeur

LINKS / LEFT / GAUCHE





CHO 000 13H

34060854 175mm Hardface

RECHTS / RIGHT / DROITE

CHO 000 14H

34060855 175mm Hardface

| | |
|---|---|
|  Unit weight | 1,90 |
|  color |  schwarz |
|  piece unit | 300 Pal |
|  accessories | 2 x K-1260 DIN 931-12.5 |







Grubberstiel

Cultivator Tines / Etancon Cultivateur

CHO 000 26

340 60 835

| | |
|---|--|
|  Unit weight | 10,80 |
|  color |  schwarz |
|  piece unit | 100 Pal |
|  accessories | |







Grubberstiel

Cultivator Tines / Etancon Cultivateur

CHO 000 28

340 60836

| | |
|---|---|
|  Unit weight | 11,90 |
|  color |  schwarz |
|  piece unit | 100 Pal |
|  accessories | |



Leitblech

Trashboard / Déflecteur

LINKS / LEFT / GAUCHE





CHO 000 29

340 60852 100x426

RECHTS / RIGHT / DROITE

CHO 000 30

340 60853 100x426

| | |
|---|--|
|  Unit weight | 2,50 |
|  color |  schwarz |
|  piece unit | 400 Pal |
|  accessories | 2 x B-1280, 548305V |



Leitblech

Trashboard / Déflecteur

LINKS / LEFT / GAUCHE





CHO 000 17VV

340 60858 12MM

RECHTS / RIGHT / DROITE

CHO 000 18VV

340 60859 12MM

| | |
|---|---|
|  Unit weight | 2,97 |
|  color |  schwarz |
|  piece unit | 300 Pal |
|  accessories | 2 x B-1280, 548305V |



Leitblech

Trashboard / Déflecteur

LINKS / LEFT / GAUCHE





CHO 000 17

340 60858 80x426

RECHTS / RIGHT / DROITE

CHO 000 18

340 60859 80x426

| | |
|---|--|
|  Unit weight | 1,98 |
|  color |  schwarz |
|  piece unit | 500 Pal |
|  accessories | 2 x B-1280, 548305V |



Teile passend zu
parts interchangeable
Pièces adaptables pour

Horsch

Leitblech

Trashboard / Déflecteur

LINKS / LEFT / GAUCHE





CHO 000 17V

340 60858 80x426x10MM

RECHTS / RIGHT / DROITE

CHO 000 18V

340 60859 10MM

| | |
|---|---|
|  Unit weight | 2,48 |
|  color |  schwarz |
|  piece unit | 400 Pal |
|  accessories | 2 x B-1280, 548305V |



Leitblech

Trashboard / Déflecteur

LINKS / LEFT / GAUCHE





CHO 000 19

340 60862 80x282

RECHTS / RIGHT / DROITE

CHO 000 20

340 60863 80x282

| | |
|---|--|
|  Unit weight | 1,25 |
|  color |  schwarz |
|  piece unit | 500 Pal |
|  accessories | 2 x B-1280, 548305V |



Leitblech

Trashboard / Déflecteur

LINKS / LEFT / GAUCHE





CHO 000 47

340 60864 80x6x310

RECHTS / RIGHT / DROITE

CHO 000 48

340 60865 80x6x310

| | |
|---|---|
|  Unit weight | 1,05 |
|  color |  schwarz |
|  piece unit | 500 Pal |
|  accessories | |



Leitblech

Trashboard / Déflecteur

LINKS / LEFT / GAUCHE





CHO 000 21

341 82600

RECHTS / RIGHT / DROITE

CHO 000 22

341 82700

| | |
|---|--|
|  Unit weight | 2,79 |
|  color |  schwarz |
|  piece unit | 300 Pal |
|  accessories | 2 x B-1280, 548305V |







Scharspitze

Share point / Nez de Soc

CHO 000 25D

003 10915 80x12 Terrano

| | |
|---|---|
|  Unit weight | 1,75 |
|  color |  schwarz |
|  piece unit | 500 Pal |
|  accessories | 1 x B-1285, 548307V |







Scharspitze

Share point / Nez de Soc

CHO 000 25VD

003 10915 Terrano 80x15

| | |
|---|--|
|  Unit weight | 2,19 |
|  color |  schwarz |
|  piece unit | 400 Pal |
|  accessories | 1 x B-1285, 548307V |







Scharspitze

Share point / Nez de Soc

CHO 000 50X

0031 0979 2-hole 80x20 CP

| | |
|---|---|
|  Unit weight | 1,90 |
|  color |  schwarz |
|  piece unit | 300 Pal |
|  accessories | 1 x B-1285, 548307V 1 x B-1290, 548310V |







Scharspitze

Share point / Nez de Soc

CHO 000 32DH

0031 0984 80x15

| | |
|---|--|
|  Unit weight | 2,30 |
|  color |  schwarz |
|  piece unit | 400 Pal |
|  accessories | 1 x B-1285, 548307V |



Teile passend zu
parts interchangeable
Pièces adaptables pour





Horsch

Scharspitze

Share point / Nez de Soc

CHO 000 50X

0031 1069 2-hole 80x20 CP

| | |
|---|---|
|  Unit weight | 1,90 |
|  color |  schwarz |
|  piece unit | 300 Pal |
|  accessories | 1 x B-1285, 548307V 1 x B-1290, 548310V |







Scharspitze

Share point / Nez de Soc

CHO 000 49DH

0031 1114 Diamant - Hardface

| | |
|---|--|
|  Unit weight | 3,20 |
|  color |  schwarz |
|  piece unit | 300 Pal |
|  accessories | 2 x B-1285, 548307V |







Scharspitze

Share point / Nez de Soc

CHO 000 49D

0031 1114 Focus Diamant

| | |
|---|---|
|  Unit weight | 3,05 |
|  color |  schwarz |
|  piece unit | 300 Pal |
|  accessories | 2 x B-1285, 548307V |







Scharspitze

Share point / Nez de Soc

CHO 000 49X

0031 1114 Focus Checkpoint

| | |
|---|--|
|  Unit weight | 3,05 |
|  color |  schwarz |
|  piece unit | 300 Pal |
|  accessories | |







Scharspitze

Share point / Nez de Soc

CHO 000 49D

0031 1350 Focus Diamant

| | |
|---|---|
|  Unit weight | 3,05 |
|  color |  schwarz |
|  piece unit | 300 Pal |
|  accessories | 2 x B-1285, 548307V |







Scharspitze

Share point / Nez de Soc

CHO 000 51X

00310979

| | |
|---|--|
|  Unit weight | 1,90 |
|  color |  schwarz |
|  piece unit | 300 Pal |
|  accessories | 1 x B-1285, 548307V |







Scharspitze

Share point / Nez de Soc

CHO 000 53X

00310979 - 1 - hole

| | |
|---|---|
|  Unit weight | 2,95 |
|  color |  schwarz |
|  piece unit | 300 Pal |
|  accessories | 1 x B-1285, 548307V |







Scharspitze

Share point / Nez de Soc

CHO 000 53X

00311069 - 1 hole

| | |
|---|--|
|  Unit weight | 2,95 |
|  color |  schwarz |
|  piece unit | 300 Pal |
|  accessories | 1 x B-1285, 548307V |



Teile passend zu
parts interchangeable
Pièces adaptables pour





Horsch

Scharspitze

Share point / Nez de Soc

CHO 000 54X

00311069 - 2 hole

| | |
|---|---|
|  Unit weight | 3,00 |
|  color |  schwarz |
|  piece unit | 300 Pal |
|  accessories | 1 x B-1285, 548307V 1 x B-1290, 548310V |







Scharspitze

Share point / Nez de Soc

CHO 000 49D

242 21700 Focus Diamant

| | |
|---|--|
|  Unit weight | 3,05 |
|  color |  schwarz |
|  piece unit | 300 Pal |
|  accessories | 2 x B-1285, 548307V |







Scharspitze

Share point / Nez de Soc

CHO 000 11

340 60580 80x20mm spitz

| | |
|---|---|
|  Unit weight | 3,00 |
|  color |  schwarz |
|  piece unit | 300 Pal |
|  accessories | 1 x B-1285, 548307V |







Scharspitze

Share point / Nez de Soc

CHO 000 12

340 60850 80 x 15mm

| | |
|---|--|
|  Unit weight | 2,20 |
|  color |  schwarz |
|  piece unit | 400 Pal |
|  accessories | 1 x B-1285, 548307V |







Scharspitze

Share point / Nez de Soc

CHO 000 10

340 60850 80x12mm

| | |
|---|---|
|  Unit weight | 1,75 |
|  color |  schwarz |
|  piece unit | 500 Pal |
|  accessories | 1 x B-1285, 548307V |







Scharspitze

Share point / Nez de Soc

CHO 000 12D

340 60850 80x15 Diamant

| | |
|---|--|
|  Unit weight | 2,25 |
|  color |  schwarz |
|  piece unit | 400 Pal |
|  accessories | 1 x B-1285, 548307V |







Scharspitze

Share point / Nez de Soc

CHO 000 11H

340 60850 80x20 hardface

| | |
|---|---|
|  Unit weight | 3,10 |
|  color |  schwarz |
|  piece unit | 300 Pal |
|  accessories | 1 x B-1285, 548307V |







Scharspitze

Share point / Nez de Soc

CHO 000 10H

340 60850 80x12 hardface

| | |
|---|--|
|  Unit weight | 1,85 |
|  color |  schwarz |
|  piece unit | 500 Pal |
|  accessories | 1 x B-1285, 548307V |







Teile passend zu
parts interchangeable
Pièces adaptables pour

Horsch

Scharspitze
Share point / Nez de Soc

CHO 000 12H

340 60850 80x15 *hardface*



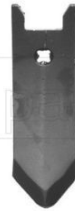

| | |
|---|---|
|  Unit weight | 2,32 |
|  color |  schwarz |
|  piece unit | 400 Pal |
|  accessories | 1 x B-1285, 548307V |



Scharspitze
Share point / Nez de Soc

CHO 000 10V

340 60850V 80X15MM





| | |
|---|--|
|  Unit weight | 2,20 |
|  color |  schwarz |
|  piece unit | 400 Pal |
|  accessories | 1 x B-1285, 548307V |



Scharspitze
Share point / Nez de Soc

CHO 000 10VH

340 60850VH 80X15 *hardface*





| | |
|---|---|
|  Unit weight | 2,32 |
|  color |  schwarz |
|  piece unit | 400 Pal |
|  accessories | 1 x B-1285, 548307V |



Scharspitze
Share point / Nez de Soc

CHO 000 27

340 60851 120x12



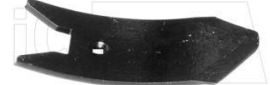

| | |
|---|--|
|  Unit weight | 2,65 |
|  color |  schwarz |
|  piece unit | 400 Pal |
|  accessories | 1 x B-1285, 548307V |



Scharspitze
Share point / Nez de Soc

CHO 000 10VD

34060850D 80X15 *DIAMANT*





| | |
|---|---|
|  Unit weight | 2,25 |
|  color |  schwarz |
|  piece unit | 400 Pal |
|  accessories | 1 x B-1285, 548307V |



Scharspitze
Share point / Nez de Soc

CHO 000 53X

CH00053X - 1 hole





| | |
|---|--|
|  Unit weight | 2,95 |
|  color |  schwarz |
|  piece unit | 300 Pal |
|  accessories | 1 x B-1285, 548307V |



Scharspitze
Share point / Nez de Soc

CHO 000 51X

CH051X 80x20 Checkpoints





| | |
|---|---|
|  Unit weight | 1,90 |
|  color |  schwarz |
|  piece unit | 300 Pal |
|  accessories | 1 x B-1285, 548307V |



Scharspitze
Share point / Nez de Soc

CHO 000 53DH

CH053DH-1 hole-80x20

| | |
|---|--|
|  Unit weight | 2,95 |
|  color |  schwarz |
|  piece unit | 300 Pal |
|  accessories | 1 x B-1285, 548307V |



Teile passend zu
parts interchangeable
Pièces adaptables pour





Horsch

Scharspitze

Share point / Nez de Soc

CHO 000 54

CH054 2 hole 80x20

| | |
|---|---|
|  Unit weight | 3,00 |
|  color |  schwarz |
|  piece unit | 300 Pal |
|  accessories | 1 x B-1285, 548307V 1 x B-1290, 548310V |







Scharspitze

Share point / Nez de Soc

CHO 000 54D

CH054D 2-hole 80x20 DIAMANT

| | |
|---|--|
|  Unit weight | 3,15 |
|  color |  schwarz |
|  piece unit | 300 Pal |
|  accessories | 1 x B-1285, 548307V 1 x B-1290, 548310V |







Scharspitze

Share point / Nez de Soc

CHO 000 54DH

CH054DH-2 hole 80x20 Diamant/H

| | |
|---|---|
|  Unit weight | 3,20 |
|  color |  schwarz |
|  piece unit | 300 Pal |
|  accessories | 1 x B-1285, 548307V 1 x B-1290, 548310V |







Scharspitze

Share point / Nez de Soc

CHO 000 54H

CH054H 2-hole 80x20 hardface

| | |
|---|--|
|  Unit weight | 3,15 |
|  color |  schwarz |
|  piece unit | 300 Pal |
|  accessories | 1 x B-1285, 548307V 1 x B-1290, 548310V |







Scharspitze

Share point / Nez de Soc

CHO 000 54X

CH054X - 2 hole

| | |
|---|---|
|  Unit weight | 3,00 |
|  color |  schwarz |
|  piece unit | 300 Pal |
|  accessories | 1 x B-1285, 548307V 1 x B-1290, 548310V |







Teile passend zu
parts interchangeable
Pièces adaptables pour

JOHN DEERE

Gänsefußschar
Sweep / Socs Patte d'oise

CV0 080 23

JD 100 100x6MM





| | |
|---|---|
|  Unit weight | 0,85 |
|  color |  schwarz |
|  piece unit | 500 Pal |
|  accessories | 2 x B-1270 2700 2613, |



Gänsefußschar
Sweep / Socs Patte d'oise

CV0 080 16

JD270 270x6MM





| | |
|---|--|
|  Unit weight | 1,47 |
|  color |  schwarz |
|  piece unit | 500 Pal |
|  accessories | 2 x B-1270 2700 2613, |



Gänsefußschar
Sweep / Socs Patte d'oise

CV0 080 16V

JD270 x 8MM





| | |
|---|---|
|  Unit weight | 2,00 |
|  color |  roh |
|  piece unit | 500 Pal |
|  accessories | 2 x B-1270 2700 2613, |



Gänsefußschar
Sweep / Socs Patte d'oise

CV0 080 16VV

JD270VV 270x10

| | |
|---|--|
|  Unit weight | 2,50 |
|  color |  roh |
|  piece unit | 200 Pal |
|  accessories | 2 x B-1270 2700 2613, |



Teile passend zu
parts interchangeable
Pièces adaptables pour





KERNER

Flügelschare

Winged share / Ailette de Dechaumeur

CK4 000 05

92275 480x10

| | |
|---|---------------------|
|  Unit weight | 6,60 |
|  color | ■ schwarz |
|  piece unit | 50 Pal |
|  accessories | 1 x B-1260, 548250V |







Flügelschare

Winged share / Ailette de Dechaumeur

CK4 000 02

92276 450x10

| | |
|---|---------------------|
|  Unit weight | 6,60 |
|  color | ■ schwarz |
|  piece unit | 50 Pal |
|  accessories | 1 x B-1260, 548250V |







Leitblech

Trashboard / Déflecteur

CK4 000 14

92 345 80x8

| | |
|---|---------------------|
|  Unit weight | 1,43 |
|  color | ■ schwarz |
|  piece unit | 500 Pal |
|  accessories | 1 x B-1280, 548305v |

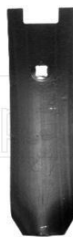





Leitblech

Trashboard / Déflecteur

CL1 001 32

92274 100x8

| | |
|---|---------------------|
|  Unit weight | 1,78 |
|  color | ■ blau |
|  piece unit | 500 Pal |
|  accessories | 1 x B-1280, 548305V |







Scharspitze

Share point / Nez de Soc

CK4 000 08

92237 - 120x12

| | |
|---|---------------------|
|  Unit weight | 1,80 |
|  color | ■ schwarz |
|  piece unit | 500 Pal |
|  accessories | 1 x D-1640, 548351v |







Scharspitze

Share point / Nez de Soc

CK4 000 08H

92238 120x12 Hardface

| | |
|---|-----------|
|  Unit weight | 2,20 |
|  color | ■ schwarz |
|  piece unit | 500 Pal |
|  accessories | |







Scharspitze

Share point / Nez de Soc

CK4 000 03

62677 / S015133 120x10

| | |
|---|-----------------------|
|  Unit weight | 1,82 |
|  color | ■ schwarz |
|  piece unit | 500 Pal |
|  accessories | 1 x B-1270 2700 2613, |







Scharspitze

Share point / Nez de Soc

CK4 000 04

92229 100x12MM

| | |
|---|---------------------|
|  Unit weight | 1,82 |
|  color | ■ schwarz |
|  piece unit | 500 Pal |
|  accessories | 1 x D-1640, 548351V |

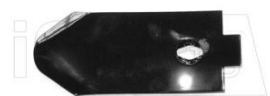





Teile passend zu
parts interchangeable
Pièces adaptables pour

KERNER

Scharspitze
Share point / Nez de Soc

CK4 000 19X

92235 CHECKPOINTS





| | | |
|---|-------------|---------|
|  | Unit weight | 2,40 |
|  | color | |
|  | piece unit | 500 Pal |
|  | accessories | |



Scharspitze
Share point / Nez de Soc

CK4 000 01

92281 120x10





| | | |
|---|-------------|---------------------|
|  | Unit weight | 1,75 |
|  | color | ■ schwarz |
|  | piece unit | 500 Pal |
|  | accessories | 1 x D-1640, 548351V |



Scharspitze
Share point / Nez de Soc

CK4 000 01H

92281 - 120x10 hardface





| | | |
|---|-------------|---------------------|
|  | Unit weight | 1,80 |
|  | color | ■ schwarz |
|  | piece unit | 500 Pal |
|  | accessories | 1 x D-1640, 548351V |



Scharspitze
Share point / Nez de Soc

CK4 000 04H

92344 100x12 hardface

| | | |
|---|-------------|---------------------|
|  | Unit weight | 2,00 |
|  | color | ■ schwarz |
|  | piece unit | 500 Pal |
|  | accessories | 1 x D-1640, 548351v |







Teile passend zu
parts interchangeable
Pièces adaptables pour

KÖCKERLING

CK4 100 16D

506025 350 x 10 Diamant





| | |
|---|---|
|  Unit weight | 0,00 |
|  color |  schwarz |
|  piece unit | |
|  accessories | |

Flügelschare

Winged share / Ailette de Dechaumeur

CK4 100 12

506015 Topmix 310x10

| | |
|---|--|
|  Unit weight | 4,80 |
|  color |  schwarz |
|  piece unit | 200 Pal |
|  accessories | 1 x K-1260 DIN 931-12.5 |

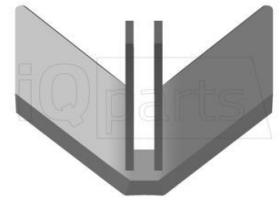





Flügelschare

Winged share / Ailette de Dechaumeur

CK4 100 16

506025 Topmix 350x10

| | |
|---|---|
|  Unit weight | 4,65 |
|  color |  schwarz |
|  piece unit | 200 Pal |
|  accessories | 1 x K-1260 DIN 931-12.5 |

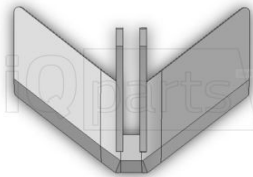





Gänsefußschar

Sweep / Socs Patte d'oise

CK4 100 18

504011 260x50x6

| | |
|---|--|
|  Unit weight | 0,71 |
|  color |  schwarz |
|  piece unit | 300 Pal |
|  accessories | 1 x Q-1060 M10x60-10. |







Gänsefußschar

Sweep / Socs Patte d'oise

CK4 100 18V

504011V 260X50X8

| | |
|---|---|
|  Unit weight | 0,95 |
|  color |  schwarz |
|  piece unit | 300 Pal |
|  accessories | 1 x Q-1060 M10x60-10. |







Gänsefußschar

Sweep / Socs Patte d'oise

CK4 100 19

504019 - 2 hole 52x10x300

| | |
|---|--|
|  Unit weight | 1,30 |
|  color |  schwarz |
|  piece unit | 300 Pal |
|  accessories | 2 x R-1060 M10 x 60 M |







Gänsefußschar

Sweep / Socs Patte d'oise

CK4 100 27

504019 - 3 hole 52x10x300

| | |
|---|---|
|  Unit weight | 1,30 |
|  color |  schwarz |
|  piece unit | 300 Pal |
|  accessories | 2 x R-1060 M10 x 60 M |







Gänsefußschar

Sweep / Socs Patte d'oise

CK4 100 19H

504019H 300X52X10 2-Hole

| | |
|---|--|
|  Unit weight | 1,40 |
|  color |  schwarz |
|  piece unit | 300 Pal |
|  accessories | 2 x R-1060 M10 x 60 M |



Teile passend zu
parts interchangeable
Pièces adaptables pour





KÖCKERLING

Gänsefußschar

Sweep / Socs Patte d'oise

CK4 100 19N

504019N 2-hole 300x52x10

| | |
|---|---|
|  Unit weight | 1,30 |
|  color |  schwarz |
|  piece unit | 300 Pal |
|  accessories | 2 x Q-1060 M10x60-10. |







Gänsefußschar

Sweep / Socs Patte d'oise

CK4 100 27N

504019N 3-hol 300x52x10 Q-1060

| | |
|---|--|
|  Unit weight | 1,30 |
|  color |  schwarz |
|  piece unit | 300 Pal |
|  accessories | 2 x Q-1060 M10x60-10. |







Gänsefußschar

Sweep / Socs Patte d'oise

CK4 100 19NH

504019NH 2-hole f. bolt Q-1060

| | |
|---|---|
|  Unit weight | 1,40 |
|  color |  schwarz |
|  piece unit | 300 Pal |
|  accessories | 2 x Q-1060 M10x60-10. |







Gänsefußschar

Sweep / Socs Patte d'oise

CK4 100 14

504027 180x6mm

| | |
|---|--|
|  Unit weight | 0,95 |
|  color |  schwarz |
|  piece unit | 500 Pal |
|  accessories | 2 x Q-1060 M10x60-10. |

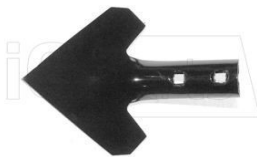





Gänsefußschar

Sweep / Socs Patte d'oise

CK4 100 15

504032 200x6

| | |
|---|---|
|  Unit weight | 1,08 |
|  color |  schwarz |
|  piece unit | 500 Pal |
|  accessories | 2 x Q-1060 M10x60-10. |







Gänsefußschar

Sweep / Socs Patte d'oise

CK4 100 15H

504032H 200X6

| | |
|---|--|
|  Unit weight | 1,20 |
|  color |  schwarz |
|  piece unit | 500 Pal |
|  accessories | 2 x Q-1060 M10x60-10. |







Grubberschar

Cultivator Point / Soc double coeur

CK4 100 01

506008 16x60x470xR300

| | |
|---|---|
|  Unit weight | 3,61 |
|  color |  schwarz |
|  piece unit | 250 Pal |
|  accessories | 2 x B-1270 2700 2613, |







Grubberschar

Cultivator Point / Soc double coeur

CK4 100 08

506008A 16x60x470 LL R300

| | |
|---|--|
|  Unit weight | 3,40 |
|  color |  schwarz |
|  piece unit | 250 Pal |
|  accessories | 2 x B-1270 2700 2613, |







Teile passend zu
parts interchangeable
Pièces adaptables pour

KÖCKERLING

Grubberschar
Cultivator Point / Soc double coeur

CK4 100 08H

506008AC-16x60x470 LL *hardface*





| | |
|---|---|
|  Unit weight | 3,65 |
|  color |  schwarz |
|  piece unit | 250 Pal |
|  accessories | 2 x B-1270 2700 2613, |



Grubberschar
Cultivator Point / Soc double coeur

CK4 100 22

506008B 16x60x490 LL





| | |
|---|--|
|  Unit weight | 3,65 |
|  color |  schwarz |
|  piece unit | 250 Pal |
|  accessories | 2 x B-1270 2700 2613, |



Grubberschar
Cultivator Point / Soc double coeur

CK4 100 01H

506008C 506006 16x60x470





| | |
|---|---|
|  Unit weight | 3,80 |
|  color |  schwarz |
|  piece unit | 250 Pal |
|  accessories | 2 x B-1270 2700 2613, |



Grubberschar
Cultivator Point / Soc double coeur

CK4 100 05

506009 15x55x410





| | |
|---|--|
|  Unit weight | 2,42 |
|  color |  schwarz |
|  piece unit | 250 Pal |
|  accessories | 2 x B-1270 2700 2613, |



Grubberschar
Cultivator Point / Soc double coeur

CK4 100 20

506009A 15x55x410- 45-75 (1LL)





| | |
|---|---|
|  Unit weight | 2,55 |
|  color |  schwarz |
|  piece unit | 250 Pal |
|  accessories | 2 x B-1270 2700 2613, |



Grubberschar
Cultivator Point / Soc double coeur

CK4 100 05H

506009H 15X55X410





| | |
|---|--|
|  Unit weight | 2,56 |
|  color |  schwarz |
|  piece unit | 250 |
|  accessories | 2 x B-1270 2700 2613, |



Grubberschar
Cultivator Point / Soc double coeur

CK4 100 02

506033 12x100x420xR263





| | |
|---|---|
|  Unit weight | 3,83 |
|  color |  schwarz |
|  piece unit | 250 Pal |
|  accessories | 2 x B-1270 2700 2613, |



Grubberschar
Cultivator Point / Soc double coeur

CK4 100 21DH

506068 40x20x600 *Diamant*

| | |
|---|--|
|  Unit weight | 3,85 |
|  color |  schwarz |
|  piece unit | 250 Pal |
|  accessories | 2 x B-1290, 548310V |







Teile passend zu
parts interchangeable
Pièces adaptables pour

KÖCKERLING

Grubberschar Cultivator Point / Soc double coeur

CK4 100 21H

506068 40x20x600 Hardface





| | | |
|---|-------------|---------------------|
|  | Unit weight | 3,80 |
|  | color | ■ schwarz |
|  | piece unit | 250 Pal |
|  | accessories | 2 x B-1290, 548310V |



Grubberschar Cultivator Point / Soc double coeur

CK4 100 21X

506068 Checkpoint 40x20





| | | |
|---|-------------|---------------------|
|  | Unit weight | 3,85 |
|  | color | ■ schwarz |
|  | piece unit | 250 Pal |
|  | accessories | 2 x B-1290, 548310V |



Grubberschar Cultivator Point / Soc double coeur

CK4 100 03

900033 100x12x475





| | | |
|---|-------------|-----------------------|
|  | Unit weight | 4,30 |
|  | color | ■ schwarz |
|  | piece unit | 200 Pal |
|  | accessories | 2 x B-1270 2700 2613, |



Grubberschar Cultivator Point / Soc double coeur

CK4 100 04

900835 12x130x450





| | | |
|---|-------------|-----------------------|
|  | Unit weight | 4,85 |
|  | color | ■ schwarz |
|  | piece unit | 200 Pal |
|  | accessories | 2 x B-1270 2700 2613, |



Grubberschar Cultivator Point / Soc double coeur

CK4 100 25DH

915376 45x25x490





| | | |
|---|-------------|---------------------|
|  | Unit weight | 5,20 |
|  | color | ■ schwarz |
|  | piece unit | 200 Pal |
|  | accessories | 2 x B-1290, 548310V |



Grubberschar Cultivator Point / Soc double coeur

CK4 100 25H

915376 45x25x490 HARDFACE





| | | |
|---|-------------|---------------------|
|  | Unit weight | 5,20 |
|  | color | ■ schwarz |
|  | piece unit | 200 Pal |
|  | accessories | 2 x B-1290, 548310V |



Grubberschar Cultivator Point / Soc double coeur

CK4 100 25

915376 45x25x490





| | | |
|---|-------------|---------------------|
|  | Unit weight | 5,06 |
|  | color | ■ schwarz |
|  | piece unit | 200 Pal |
|  | accessories | 2 x B-1290, 548310V |



Grubberschar Cultivator Point / Soc double coeur

CK4 100 21X

915774 Checkpoint 40x20

| | | |
|---|-------------|---------------------|
|  | Unit weight | 3,85 |
|  | color | ■ schwarz |
|  | piece unit | 250 Pal |
|  | accessories | 2 x B-1290, 548310V |



Teile passend zu
parts interchangeable
Pièces adaptables pour





KÖCKERLING

Grubberstiel

Cultivator Tines / Etancon Cultivateur

CK4 100 17E

2000-2517/2

| | |
|---|---|
|  Unit weight | 10,16 |
|  color |  schwarz |
|  piece unit | |
|  accessories | |







Grubberstiel

Cultivator Tines / Etancon Cultivateur

CK4 100 17

506048

| | |
|---|--|
|  Unit weight | 8,80 |
|  color |  schwarz |
|  piece unit | 100 Pal |
|  accessories | |



Leitblech

Trashboard / Déflecteur

LINKS / LEFT / GAUCHE





CK4 100 10

506001 80x8x428

RECHTS / RIGHT / DROITE

CK4 100 09

506000 80x8x428

| | |
|---|---|
|  Unit weight | 2,00 |
|  color |  schwarz |
|  piece unit | 500 Pal |
|  accessories | 1 x B-1285, 548307V |







Leitblech

Trashboard / Déflecteur

CK4 100 11

506046 80x08x428

| | |
|---|--|
|  Unit weight | 2,00 |
|  color |  schwarz |
|  piece unit | 500 Pal |
|  accessories | 1 x B-1285, 548307V |







Scharspitze

Share point / Nez de Soc

CK4 100 07V

506 065V 80 x 20mm

| | |
|---|---|
|  Unit weight | 3,60 |
|  color |  schwarz |
|  piece unit | 300 Pal |
|  accessories | 1 x B-1285, 548307V |







Scharspitze

Share point / Nez de Soc

CK4 100 06

506014 100x12

| | |
|---|--|
|  Unit weight | 2,30 |
|  color |  schwarz |
|  piece unit | 300 Pal |
|  accessories | 1 x B-1285, 548307V |

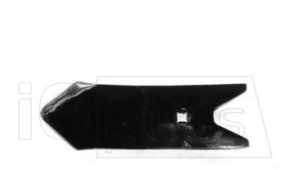





Scharspitze

Share point / Nez de Soc

CK4 100 06H

506014C 100x12 Hardface

| | |
|---|---|
|  Unit weight | 2,50 |
|  color |  schwarz |
|  piece unit | 300 Pal |
|  accessories | 1 x B-1285, 548307V |







Scharspitze

Share point / Nez de Soc

CK4 100 13H

506062 80x12 hardface

| | |
|---|--|
|  Unit weight | 1,90 |
|  color |  schwarz |
|  piece unit | 400 Pal |
|  accessories | 1 x B-1285, 548307V |



Teile passend zu
parts interchangeable
Pièces adaptables pour





KÖCKERLING

Scharspitze

Share point / Nez de Soc

CK4 100 13

506064 80 x 12MM

| | |
|---|---------------------|
|  Unit weight | 1,80 |
|  color | ■ schwarz |
|  piece unit | 400 Pal |
|  accessories | 1 x B-1285, 548307V |







Scharspitze

Share point / Nez de Soc

CK4 100 07

506065 80x15

| | |
|---|---------------------|
|  Unit weight | 2,20 |
|  color | ■ schwarz |
|  piece unit | 400 Pal |
|  accessories | 1 x B-1285, 548307V |







Scharspitze

Share point / Nez de Soc

CK4 100 07H

506069 80x15 hardface

| | |
|---|---------------------|
|  Unit weight | 2,20 |
|  color | ■ schwarz |
|  piece unit | 400 Pal |
|  accessories | 1 x B-1285, 548307V |







Scharspitze

Share point / Nez de Soc

CK4 100 26VH

506069 SH 80x20 hardface spitz

| | |
|---|---------------------|
|  Unit weight | 2,60 |
|  color | ■ schwarz |
|  piece unit | 300 |
|  accessories | 1 x B-1285, 548307V |







Scharspitze

Share point / Nez de Soc

CK4 100 07VH

506069V 80x20 hardface

| | |
|---|---------------------|
|  Unit weight | 2,60 |
|  color | ■ schwarz |
|  piece unit | 300 Pal |
|  accessories | 1 x B-1285, 548307V |







Scharspitze

Share point / Nez de Soc

CK4 100 24X

915 776 - 2 hole Checkpoint

| | |
|---|---------------------|
|  Unit weight | 3,27 |
|  color | ■ schwarz |
|  piece unit | 300 Pal |
|  accessories | 2 x B-1285, 548307V |







Scharspitze

Share point / Nez de Soc

CK4 100 23X

CK41 023X 80x20 Check points

| | |
|---|---------------------|
|  Unit weight | 1,90 |
|  color | ■ schwarz |
|  piece unit | 300 Pal |
|  accessories | 1 x B-1285, 548307V |







Scharspitze

Share point / Nez de Soc

CK4 100 23DH

CK410023DH 80x20 Hardf/Diamant

| | |
|---|---------------------|
|  Unit weight | 3,20 |
|  color | ■ schwarz |
|  piece unit | 300 Pal |
|  accessories | 1 x B-1285, 548307V |







Teile passend zu
parts interchangeable
Pièces adaptables pour

KÖCKERLING

Scharspitze
Share point / Nez de Soc

CK4 100 24DH

CK410024DH 80x20 Hardf/Diamant

| | | |
|---|---------------|---|
|  | Unit weight | 3,70 |
|  | color | ■ schwarz |
|  | piece unit | 300 Pal |
|  | accessories | 1 x B-1285, 548307V 1 x B-1290, 548310V |



Teile passend zu
parts interchangeable
Pièces adaptables pour

Kongskilde

Federzinke mit Schar

S-tine with share / Dent ressort avec soc

CU1 000 04

0100 0740

| | | |
|--|-------------|-----------|
| | Unit weight | 3,50 |
| | color | ■ schwarz |
| | piece unit | 250 Pal |
| | accessories | |



Flügelschare

Winged share / Ailette de Dechaumeur

LINKS / LEFT / GAUCHE

CK5 000 05

101003132 180X10 DELTAFLEX

RECHTS / RIGHT / DROITE

CK5 000 04

101003131 180X10 DELTAFLEX

| | | |
|--|-------------|-------------------------|
| | Unit weight | 2,00 |
| | color | ■ schwarz |
| | piece unit | 300 Pal |
| | accessories | 2 x K-1260 DIN 931-12.9 |



Grubberstiel

Cultivator Tines / Etancon Cultivateur

CK5 000 01

101003130 DELTAFLEX

| | | |
|--|-------------|-----------|
| | Unit weight | 11,70 |
| | color | ■ schwarz |
| | piece unit | 100 Pal |
| | accessories | |



Leitblech

Trashboard / Déflecteur

CK5 000 03

101003121 80X10 DELTAFLEX

| | | |
|--|-------------|---------------------|
| | Unit weight | 2,33 |
| | color | ■ schwarz |
| | piece unit | 500 Pal |
| | accessories | 1 x B-1285, 548307V |



Scharspitze

Share point / Nez de Soc

CK5 000 02

101003120K 80X12 DELTAFLEX

| | | |
|--|-------------|-----------------------|
| | Unit weight | 1,83 |
| | color | ■ schwarz |
| | piece unit | 500 Pal |
| | accessories | 1 x B-1270 2700 2613, |



Scharspitze

Share point / Nez de Soc

CK5 000 06

105000792 Vibro Flex

| | | |
|--|-------------|-----------|
| | Unit weight | 2,90 |
| | color | ■ schwarz |
| | piece unit | 300 Pal |
| | accessories | |

Teile passend zu
parts interchangeable
Pièces adaptables pour

KUHN

Flügelschare

Winged share / Ailette de Dechaumeur

LINKS / LEFT / GAUCHE





CK3 001 55

H2212511

RECHTS / RIGHT / DROITE

CK3 001 54

H2212501

| | | |
|---|---------------|---|
|  | Unit weight | 1,95 |
|  | color |  schwarz |
|  | piece unit | 300 Pal |
|  | accessories | |

Teile passend zu
parts interchangeable
Pièces adaptables pour

Kuhn / Huard

Flügelshare

Winged share / Ailette de Dechaumeur

LINKS / LEFT / GAUCHE





CK3 001 17

2212510

RECHTS / RIGHT / DROITE

CK3 001 16

2212500

| | |
|---|---|
|  Unit weight | 1,90 |
|  color |  schwarz |
|  piece unit | 300 Pal |
|  accessories | |



Flügelshare

Winged share / Ailette de Dechaumeur

LINKS / LEFT / GAUCHE





CK3 001 17H

2212510H Hardface

RECHTS / RIGHT / DROITE

CK3 001 16H

2212500H Hardface

| | |
|---|--|
|  Unit weight | 2,00 |
|  color |  schwarz |
|  piece unit | 300 Pal |
|  accessories | |



Flügelshare

Winged share / Ailette de Dechaumeur

LINKS / LEFT / GAUCHE





CK3 001 17

H2212510

RECHTS / RIGHT / DROITE

CK3 001 16

H2212500

| | |
|---|---|
|  Unit weight | 1,90 |
|  color |  schwarz |
|  piece unit | 300 Pal |
|  accessories | |



Flügelshare

Winged share / Ailette de Dechaumeur

LINKS / LEFT / GAUCHE





CK3 001 17H

H2212510H Hardface

RECHTS / RIGHT / DROITE

CK3 001 16H

H2212500H Hardface

| | |
|---|--|
|  Unit weight | 2,00 |
|  color |  schwarz |
|  piece unit | 300 Pal |
|  accessories | |



Leitblech

Trashboard / Déflecteur

LINKS / LEFT / GAUCHE





CK3 001 15

221269

RECHTS / RIGHT / DROITE

CK3 001 14

221268

| | |
|---|---|
|  Unit weight | 1,90 |
|  color |  schwarz |
|  piece unit | 500 Pal |
|  accessories | 1 x B-1280, 548305V |







Scharspitze

Share point / Nez de Soc

CK3 001 13

221254

| | |
|---|--|
|  Unit weight | 1,80 |
|  color |  schwarz |
|  piece unit | 500 Pal |
|  accessories | 2 x B-1280, 548305V |







Scharspitze

Share point / Nez de Soc

CK3 001 13

H2212540

| | |
|---|---|
|  Unit weight | 1,80 |
|  color |  schwarz |
|  piece unit | 500 Pal |
|  accessories | 2 x B-1280, 548305V |



Teile passend zu
parts interchangeable
Pièces adaptables pour

Kverneland

Flügelschare

Winged share / Ailette de Dechaumeur

LINKS / LEFT / GAUCHE







CK0 001 25

131125

RECHTS / RIGHT / DROITE

CK0 001 24

131124

| | |
|---|--|
|  Unit weight | 1,85 |
|  color |  grün |
|  piece | 350 |
|  unit | Pal |
|  accessories | 3 x G-1234, 523998V |









Scharspitze

Share point / Nez de Soc

CK4 000 03

62677 / S015133 120x10

| | |
|---|--|
|  Unit weight | 1,82 |
|  color |  schwarz |
|  piece | 500 |
|  unit | Pal |
|  accessories | 1 x B-1270 2700 2613, |



Teile passend zu
parts interchangeable
Pièces adaptables pour

Lemken

Flügelschare

Winged share / Ailette de Dechaumeur

LINKS / LEFT / GAUCHE





CL1 001 34

337 4417 FL35D

RECHTS / RIGHT / DROITE

CL1 001 33

337 4416 FL35D

| | |
|---|--|
|  Unit weight | 2,90 |
|  color |  blau |
|  piece unit | 350 Pal |
|  accessories | 2 x P-1235 M12x35 Mu, |



Flügelschare

Winged share / Ailette de Dechaumeur

LINKS / LEFT / GAUCHE





CL1 001 36

337 4419 FL35D gekr 214MM

RECHTS / RIGHT / DROITE

CL1 001 35

337 4418 FL35D gekr 214MM

| | |
|---|---|
|  Unit weight | 2,67 |
|  color |  blau |
|  piece unit | 350 Pal |
|  accessories | 2 x P-1235 M12x35 Mu, |



Flügelschare

Winged share / Ailette de Dechaumeur

LINKS / LEFT / GAUCHE





CL1 001 97

337 4419A 226MM

RECHTS / RIGHT / DROITE

CL1 001 96

337 4418 226MM

| | |
|---|--|
|  Unit weight | 2,70 |
|  color |  blau |
|  piece unit | 350 Pal |
|  accessories | 2 x P-1235 M12x35 Mu, |



Flügelschare

Winged share / Ailette de Dechaumeur

LINKS / LEFT / GAUCHE





CL1 001 39

337 4421 FL37D gekr

RECHTS / RIGHT / DROITE

CL1 001 38

337 4420 FL37D gekr

| | |
|---|---|
|  Unit weight | 3,00 |
|  color |  blau |
|  piece unit | 350 Pal |
|  accessories | 2 x P-1235 M12x35 Mu, |



Flügelschare

Winged share / Ailette de Dechaumeur

LINKS / LEFT / GAUCHE





CL1 001 39H

337 4425C Hardface

RECHTS / RIGHT / DROITE

CL1 001 38H

337 4424C Hardface

| | |
|---|--|
|  Unit weight | 3,30 |
|  color |  blau |
|  piece unit | 350 Pal |
|  accessories | 2 x P-1235 M12x35 Mu, |



Flügelschare

Winged share / Ailette de Dechaumeur

LINKS / LEFT / GAUCHE





CL1 001 89

337 4429 FL 23 D

RECHTS / RIGHT / DROITE

CL1 001 88

337 4428 FL 23 D

| | |
|---|---|
|  Unit weight | 1,75 |
|  color |  blau |
|  piece unit | 500 Pal |
|  accessories | 2 x P-1235 M12x35 Mu, |



Flügelschare

Winged share / Ailette de Dechaumeur

LINKS / LEFT / GAUCHE





CL1 002 02

337 4461 KF30

RECHTS / RIGHT / DROITE

CL1 002 01

337 4460 KF30

| | |
|---|--|
|  Unit weight | 2,10 |
|  color |  blau |
|  piece unit | 500 Pal |
|  accessories | |



Flügelschare

Winged share / Ailette de Dechaumeur

LINKS / LEFT / GAUCHE





CL1 002 02H

337 4463 KF30P hardface

RECHTS / RIGHT / DROITE

CL1 002 01H

337 4462 KF30P hardface

| | |
|---|---|
|  Unit weight | 2,15 |
|  color |  blau |
|  piece unit | 500 Pal |
|  accessories | |



Teile passend zu
parts interchangeable
Pièces adaptables pour





Lemken

Gänsefußschar

Sweep / Socs Patte d'oise

CL1 001 08

337 4356 G25

| | |
|---|--|
|  Unit weight | 0,80 |
|  color |  blau |
|  piece unit | 500 Pal |
|  accessories | |







Gänsefußschar

Sweep / Socs Patte d'oise

CL1 002 28

337 4357 G28 280x5MM

| | |
|---|---|
|  Unit weight | 0,90 |
|  color |  blau |
|  piece unit | 500 Pal |
|  accessories | |







Grubberschar

Cultivator Point / Soc double coeur

CL1 002 12

337 1686 Labrador

| | |
|---|--|
|  Unit weight | 6,60 |
|  color |  blau |
|  piece unit | |
|  accessories | 2 x B-1260, 548250V |







Grubberschar

Cultivator Point / Soc double coeur

CL1 002 11

337 10006

| | |
|---|---|
|  Unit weight | 6,40 |
|  color |  blau |
|  piece unit | 150 Pal |
|  accessories | 2 x B-1280, 548305V |







Grubberstiel

Cultivator Tines / Etancon Cultivateur

CV0 050 09

60x25x850

| | |
|---|--|
|  Unit weight | 9,80 |
|  color |  blau |
|  piece unit | 100 Pal |
|  accessories | |







Leitblech

Trashboard / Déflecteur

CL1 001 32

337 4395 100x8 LB1

| | |
|---|---|
|  Unit weight | 1,78 |
|  color |  blau |
|  piece unit | 500 Pal |
|  accessories | 1 x B-1280, 548305V |







Leitblech

Trashboard / Déflecteur

LINKS / LEFT / GAUCHE

CL1 001 44

337 4399

| | |
|---|--|
|  Unit weight | 2,45 |
|  color |  blau |
|  piece unit | 400 Pal |
|  accessories | 1 x B-1280, 548305V |



RECHTS / RIGHT / DROITE

CL1 001 43





XL 016

Leitblech

Trashboard / Déflecteur

CK4 000 14

337 4401 80x8

| | |
|---|--|
|  Unit weight | 1,43 |
|  color |  schwarz |
|  piece unit | 500 Pal |
|  accessories | 1 x B-1280, 548305V |



Teile passend zu
parts interchangeable
Pièces adaptables pour





Lemken

Leitblech

Trashboard / Déflecteur

CL1 002 03

337 4482 KL8

| | |
|---|--|
|  Unit weight | 1,55 |
|  color |  blau |
|  piece unit | 500 Pal |
|  accessories | 1 x B-1280, 548305V |







Leitblech

Trashboard / Déflecteur

CL1 002 00

337 4484 KL10

| | |
|---|---|
|  Unit weight | 1,95 |
|  color |  blau |
|  piece unit | 500 Pal |
|  accessories | 1 x B-1280, 548305V |







Leitblech

Trashboard / Déflecteur

LINKS / LEFT / GAUCHE

CL1 002 05

337 4491 KR10

| | |
|---|--|
|  Unit weight | 1,95 |
|  color |  blau |
|  piece unit | 500 Pal |
|  accessories | 1 x B-1280, 548305V |



RECHTS / RIGHT / DROITE

CL1 002 04





337 4490 KR10

Scharfuß

Holder / Contre Sep

CL1 001 49

467 9105 (10mm)

| | |
|---|---|
|  Unit weight | 2,75 |
|  color |  blau |
|  piece unit | 300 Pal |
|  accessories | 1 x B-1260, 548250V |







Scharfuß

Holder / Contre Sep

CL1 001 49

467 9106 (10MM)

| | |
|---|--|
|  Unit weight | 2,75 |
|  color |  blau |
|  piece unit | 300 Pal |
|  accessories | 1 x B-1260, 548250V |







Scharfuß

Holder / Contre Sep

CL1 001 49

467 9107 (10MM)

| | |
|---|---|
|  Unit weight | 2,75 |
|  color |  blau |
|  piece unit | 300 Pal |
|  accessories | 1 x B-1260, 548250V |







Scharspitze

Share point / Nez de Soc

CL1 001 52H

337 4386 80x12 hardface

| | |
|---|--|
|  Unit weight | 1,70 |
|  color |  blau |
|  piece unit | 500 Pal |
|  accessories | 1 x B-1235 - 3015785, 5 |







Scharspitze

Share point / Nez de Soc

CL1 001 52

337 4386 58P 80x12MM

| | |
|---|---|
|  Unit weight | 1,70 |
|  color |  blau |
|  piece unit | 500 Pal |
|  accessories | 1 x B-1235 - 3015785, 5 |







Teile passend zu
parts interchangeable
Pièces adaptables pour

Lemken

Scharspitze
Share point / Nez de Soc

CL1 001 54H

337 4387 120x15 hardface





| | |
|---|--|
|  Unit weight | 2,70 |
|  color |  blau |
|  piece unit | 400 Pal |
|  accessories | 1 x B-1240 2700 2607, |



Scharspitze
Share point / Nez de Soc

CL1 001 54

337 4387 120x15mm





| | |
|---|---|
|  Unit weight | 2,63 |
|  color |  blau |
|  piece unit | 400 Pal |
|  accessories | 1 x B-1235 - 3015785, 5 |



Scharspitze
Share point / Nez de Soc

CL1 001 54D

337 4387 120x15mm Diamant





| | |
|---|--|
|  Unit weight | 2,63 |
|  color |  blau |
|  piece unit | 400 Pal |
|  accessories | 1 x B-1235 - 3015785, 5 |



Scharspitze
Share point / Nez de Soc

CL1 001 31H

337 4388 120x10MM hardface





| | |
|---|---|
|  Unit weight | 1,88 |
|  color |  blau |
|  piece unit | 500 Pal |
|  accessories | 1 x B-1235 - 3015785, 5 |



Scharspitze
Share point / Nez de Soc

CL1 001 31

337 4388 S12D 120x10MM 10mm





| | |
|---|--|
|  Unit weight | 1,75 |
|  color |  blau |
|  piece unit | 500 Pal |
|  accessories | 1 x B-1235 - 3015785, 5 |



Scharspitze
Share point / Nez de Soc

CL1 001 53

337 4391 120x12MM





| | |
|---|---|
|  Unit weight | 2,15 |
|  color |  blau |
|  piece unit | 500 Pal |
|  accessories | 1 x B-1235 - 3015785, 5 |



Scharspitze
Share point / Nez de Soc

CL1 001 53H

337 4392 120x12 hardface





| | |
|---|--|
|  Unit weight | 2,20 |
|  color |  blau |
|  piece unit | 500 Pal |
|  accessories | |



Scharspitze
Share point / Nez de Soc

CL1 001 98H

337 4441 K8P 80x15MM hardface

| | |
|---|---|
|  Unit weight | 2,10 |
|  color |  blau |
|  piece unit | 400 Pal |
|  accessories | |

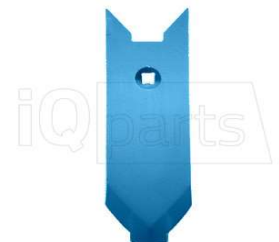

Teile passend zu
parts interchangeable
Pièces adaptables pour





Lemken

Scharspitze

Share point / Nez de Soc

CL1 001 99

337 4442 K12 120x10MM

| | |
|---|--|
|  Unit weight | 2,00 |
|  color |  blau |
|  piece unit | 400 Pal |
|  accessories | 1 x B-1240 2700 2607, |







Scharspitze

Share point / Nez de Soc

CL1 001 99H

337 4443 K12P 120x12 hardface

| | |
|---|---|
|  Unit weight | 2,50 |
|  color |  blau |
|  piece unit | 400 Pal |
|  accessories | 1 x B-1240 2700 2607, |



Teile passend zu
parts interchangeable
Pièces adaptables pour







Mandam

Flügelschare

Winged share / Ailette de Dechaumeur

CK4 100 12

05-02-0255 310x10

| | |
|---|---|
|  Unit weight | 4,80 |
|  color |  schwarz |
|  piece | 200 |
|  unit | Pal |
|  accessories | 1 x K-1260 DIN 931-12.5 |

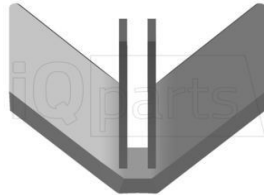

Flügelschare

Winged share / Ailette de Dechaumeur

LINKS / LEFT / GAUCHE







CH0 000 24

05-02-0462 115mm

RECHTS / RIGHT / DROITE

CH0 000 23

340 60855 115mm short

| | |
|---|--|
|  Unit weight | 1,50 |
|  color |  schwarz |
|  piece | 300 |
|  unit | Pal |
|  accessories | 2 x K-1260 DIN 931-12.5 |



Grindel

Leg / Âge

LINKS / LEFT / GAUCHE







CS0 001 17

05-02-0448

RECHTS / RIGHT / DROITE

CS0 001 16

05-02-0447

| | |
|---|---|
|  Unit weight | 24,00 |
|  color |  schwarz |
|  piece | 30 |
|  unit | Pal |
|  accessories | |

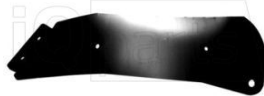







Grubberstiel

Cultivator Tines / Etancon Cultivateur

CH0 000 28

05-02-0055

| | |
|---|--|
|  Unit weight | 11,90 |
|  color |  schwarz |
|  piece | 100 |
|  unit | Pal |
|  accessories | |









Grubberstiel

Cultivator Tines / Etancon Cultivateur

CK4 100 17E

05-02-0259

| | |
|---|---|
|  Unit weight | 10,16 |
|  color |  schwarz |
|  piece | |
|  unit | |
|  accessories | |



Leitblech

Trashboard / Déflecteur

LINKS / LEFT / GAUCHE







CK4 100 10

05-02-0257 80x8x428

RECHTS / RIGHT / DROITE

CK4 100 09

506000 80x8x428

| | |
|---|--|
|  Unit weight | 2,00 |
|  color |  schwarz |
|  piece | 500 |
|  unit | Pal |
|  accessories | 1 x B-1285, 548307V |



Leitblech

Trashboard / Déflecteur

LINKS / LEFT / GAUCHE







CS0 001 15

05-02-0449

RECHTS / RIGHT / DROITE

CS0 001 14

05-02-0450

| | |
|---|---|
|  Unit weight | 4,80 |
|  color |  schwarz |
|  piece | 200 |
|  unit | Pal |
|  accessories | 1 x T-1440 M14 x 40 M |









Schare

Share / Soc

CS0 001 26

05-02-0446

| | |
|---|--|
|  Unit weight | 7,80 |
|  color |  schwarz |
|  piece | 150 |
|  unit | Pal |
|  accessories | 2 x S-1060 10x 60DIN14 2 x S-1660 16x60 DIN14 |







Teile passend zu
parts interchangeable
Pièces adaptables pour

Mandam

Scharspitze Share point / Nez de Soc

CL1 001 31

05-02-0006 120 x 10MM 10mm





| | |
|---|--|
|  Unit weight | 1,75 |
|  color |  blau |
|  piece unit | 500 Pal |
|  accessories | 1 x B-1235 - 3015785, 5 |



Scharspitze Share point / Nez de Soc

CK4 100 13

05-02-0258 80x12





| | |
|---|--|
|  Unit weight | 1,80 |
|  color |  schwarz |
|  piece unit | 400 Pal |
|  accessories | 1 x B-1285, 548307V |



Scharspitze Share point / Nez de Soc

CK4 100 07V

05-02-0554 80x20





| | |
|---|---|
|  Unit weight | 3,60 |
|  color |  schwarz |
|  piece unit | 300 Pal |
|  accessories | 1 x B-1285, 548307V |



Scharspitze Share point / Nez de Soc

CK4 100 26VH

05-02-0555 80x20 Hardface





| | |
|---|--|
|  Unit weight | 2,60 |
|  color |  schwarz |
|  piece unit | 300 |
|  accessories | 1 x B-1285, 548307V |



Scharspitze Share point / Nez de Soc

CK4 100 07VH

05-02-0555 80x20 Hardface





| | |
|---|---|
|  Unit weight | 2,60 |
|  color |  schwarz |
|  piece unit | 300 Pal |
|  accessories | 1 x B-1285, 548307V |



Schraube Screw / Boulon

582 700 V

07-02-0157





| | |
|---|--|
|  Unit weight | 0,06 |
|  color |  roh |
|  piece unit | 50 Kart |
|  accessories | |



Schraube Screw / Boulon

548 307 V

07-02-0158 M12 x 85 Mu

| | |
|---|---|
|  Unit weight | 0,09 |
|  color |  roh |
|  piece unit | 50 Kart |
|  accessories | |



Teile passend zu
parts interchangeable
Pièces adaptables pour

Maschio

Flügelschare
Winged share / Ailette de Dechaumeur

CK4 100 12

R1802 5740

| | | |
|--|-------------|-------------------------|
| | Unit weight | 4,80 |
| | color | ■ schwarz |
| | piece unit | 200 Pal |
| | accessories | 1 x K-1260 DIN 931-12.5 |

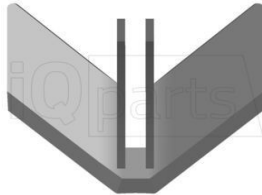

Grubberschar
Cultivator Point / Soc double coeur

CM3 000 01

R17 820 681

| | | |
|--|-------------|-----------|
| | Unit weight | 5,60 |
| | color | ■ schwarz |
| | piece unit | |
| | accessories | |



Grubberstiel
Cultivator Tines / Etancon Cultivateur

CK4 100 17

R1802 5730

| | | |
|--|-------------|-----------|
| | Unit weight | 8,80 |
| | color | ■ schwarz |
| | piece unit | 100 Pal |
| | accessories | |



Leitblech
Trashboard / Déflecteur

LINKS / LEFT / GAUCHE

CK4 100 10

R1802 5760

RECHTS / RIGHT / DROITE

CK4 100 09

506000 80x8x428

| | | |
|--|-------------|---------------------|
| | Unit weight | 2,00 |
| | color | ■ schwarz |
| | piece unit | 500 Pal |
| | accessories | 1 x B-1285, 548307V |



Scharspitze
Share point / Nez de Soc

CK4 100 13

R1802 5780

| | | |
|--|-------------|---------------------|
| | Unit weight | 1,80 |
| | color | ■ schwarz |
| | piece unit | 400 Pal |
| | accessories | 1 x B-1285, 548307V |



Teile passend zu
parts interchangeable
Pièces adaptables pour

Pöttinger Landsberg

Flügelschare

Winged share / Ailette de Dechaumeur

LINKS / LEFT / GAUCHE





CLO 000 34

939 50 221 1

RECHTS / RIGHT / DROITE

CLO 000 33

939 50 220 1

| | |
|---|--|
|  Unit weight | 1,20 |
|  color | ■ rot |
|  piece unit | 500 Pal |
|  accessories | 2 x D-1235 11014D123 |



Flügelschare

Winged share / Ailette de Dechaumeur

LINKS / LEFT / GAUCHE





CLO 000 93

966 50 021

RECHTS / RIGHT / DROITE

CLO 000 94

966 50 031

| | |
|---|--|
|  Unit weight | 2,35 |
|  color | ■ rot |
|  piece unit | 350 Pal |
|  accessories | 2 x D-1235 11014D123 |



Flügelschare

Winged share / Ailette de Dechaumeur

LINKS / LEFT / GAUCHE





CLO 001 14

976 250 0201

RECHTS / RIGHT / DROITE

CLO 001 15

976 25 00301

| | |
|---|--|
|  Unit weight | 1,76 |
|  color | ■ rot |
|  piece unit | 300 Pal |
|  accessories | 1 x K-1665, 523782AV |

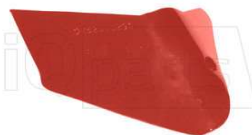

Flügelschare

Winged share / Ailette de Dechaumeur

LINKS / LEFT / GAUCHE





CLO 001 14H

9762 50 023 0 hardface

RECHTS / RIGHT / DROITE

CLO 001 15H

9762 50 024 0 Hardface

| | |
|---|--|
|  Unit weight | 1,80 |
|  color | ■ rot |
|  piece unit | 300 Pal |
|  accessories | 1 x K-1665, 523782AV |

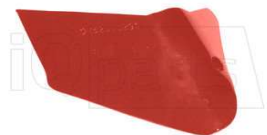

Flügelschare

Winged share / Ailette de Dechaumeur

LINKS / LEFT / GAUCHE





CLO 001 39

9781.50.020.0 500 LH SYNCRO

RECHTS / RIGHT / DROITE

CLO 001 40

9781.50.030.0 500 RH SYNCRO

| | |
|---|--|
|  Unit weight | 2,75 |
|  color | ■ schwarz |
|  piece unit | 200 Pal |
|  accessories | 1 x K-1665, 523782AV |

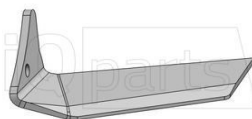





Grubberschar

Cultivator Point / Soc double coeur

CV0 045 01

054 697z

| | |
|---|--|
|  Unit weight | 3,20 |
|  color | ■ schwarz |
|  piece unit | 250 Pal |
|  accessories | 1 x B-1270 2700 2613, 1 x B-1280, 548305V |







Grubberschar

Cultivator Point / Soc double coeur

CLO 001 13

965 500 650 100x12x385

| | |
|---|--|
|  Unit weight | 3,40 |
|  color | ■ rot |
|  piece unit | 250 Pal |
|  accessories | 2 x D-1270, 546750V |



Leitblech

Trashboard / Déflecteur

LINKS / LEFT / GAUCHE





CLO 001 11

976 250 0360

RECHTS / RIGHT / DROITE

CLO 001 12

976 250 0370

| | |
|---|--|
|  Unit weight | 1,30 |
|  color | ■ rot |
|  piece unit | 500 Pal |
|  accessories | 1 x D-1285, 546850V |







Teile passend zu
parts interchangeable
Pièces adaptables pour

Pöttinger Landsberg

Scharspitze Share point / Nez de Soc

CLO 001 30

976 250 0151 80x12x307





| | |
|---|---|
|  Unit weight | 2,04 |
|  color |  rot |
|  piece unit | 500 Pal |
|  accessories | 2 x D-1285, 546850V |



Scharspitze Share point / Nez de Soc

CLO 001 30H

976 250 0151 80x12x307





| | |
|---|--|
|  Unit weight | 2,10 |
|  color |  rot |
|  piece unit | 500 Pal |
|  accessories | 2 x D-1285, 546850V |



Scharspitze Share point / Nez de Soc

CLO 001 17DH

976 250 027 80x15x302mm





| | |
|---|---|
|  Unit weight | 2,25 |
|  color |  rot |
|  piece unit | 400 Pal |
|  accessories | 2 x D-1285, 546850V |



Scharspitze Share point / Nez de Soc

CLO 001 17X

976 250 027 80x20 Checkpoint





| | |
|---|--|
|  Unit weight | 3,10 |
|  color |  rot |
|  piece unit | 300 Pal |
|  accessories | 2 x D-1285, 546850V |



Scharspitze Share point / Nez de Soc

CLO 001 17D

976 250 027 0 80x15x302

| | |
|---|---|
|  Unit weight | 2,40 |
|  color |  rot |
|  piece unit | 400 Pal |
|  accessories | 2 x D-1285, 546850V |



Teile passend zu
parts interchangeable
Pièces adaptables pour

QUIVOGNE

Flügelschare

Winged share / Ailette de Dechaumeur

LINKS / LEFT / GAUCHE





CHO 000 24

SOC 21303 115mm

RECHTS / RIGHT / DROITE

CHO 000 23

340 60855 115mm short

| | |
|---|---|
|  Unit weight | 1,50 |
|  color |  schwarz |
|  piece unit | 300 Pal |
|  accessories | 2 x K-1260 DIN 931-12.5 |



Flügelschare

Winged share / Ailette de Dechaumeur

LINKS / LEFT / GAUCHE





CHO 000 13

SOC 21318 175mm

RECHTS / RIGHT / DROITE

CHO 000 14

340 60855 175mm

| | |
|---|--|
|  Unit weight | 1,85 |
|  color |  schwarz |
|  piece unit | 300 Pal |
|  accessories | 2 x K-1260 DIN 931-12.5 |



Grindel

Leg / Âge

LINKS / LEFT / GAUCHE





CSO 001 27

DTS 10905

RECHTS / RIGHT / DROITE

CSO 001 28

DTS 10906

| | |
|---|---|
|  Unit weight | 24,20 |
|  color |  schwarz |
|  piece unit | 30 Pal |
|  accessories | |



Grindel

Leg / Âge

LINKS / LEFT / GAUCHE





CSO 001 17

DTS 10905 - 950 D16/30

RECHTS / RIGHT / DROITE

CSO 001 16

05-02-0447

| | |
|---|--|
|  Unit weight | 24,00 |
|  color |  schwarz |
|  piece unit | 30 Pal |
|  accessories | |







Grubberstiel

Cultivator Tines / Etancon Cultivateur

CHO 000 28

DTS 21300

| | |
|---|---|
|  Unit weight | 11,90 |
|  color |  schwarz |
|  piece unit | 100 Pal |
|  accessories | |







Grubberstiel

Cultivator Tines / Etancon Cultivateur

CHO 000 26

DTS 21310

| | |
|---|--|
|  Unit weight | 10,80 |
|  color |  schwarz |
|  piece unit | 100 Pal |
|  accessories | |







Leitblech

Trashboard / Déflecteur

CQO 000 03

SOC 20955 M12

| | |
|---|---|
|  Unit weight | 0,00 |
|  color |  schwarz |
|  piece unit | 500 Pal |
|  accessories | 1 x B-1270 2700 2613, |



Leitblech

Trashboard / Déflecteur

LINKS / LEFT / GAUCHE





CHO 000 17

SOC 21304

RECHTS / RIGHT / DROITE

CHO 000 18

340 60859 80x426

| | |
|---|--|
|  Unit weight | 1,98 |
|  color |  schwarz |
|  piece unit | 500 Pal |
|  accessories | 2 x B-1280, 548305V |



Teile passend zu
parts interchangeable
Pièces adaptables pour

QUIVOGNE

Leitblech

Trashboard / Déflecteur

LINKS / LEFT / GAUCHE





CS0 001 15

SSO 00115 - 950

RECHTS / RIGHT / DROITE

CS0 001 14

05-02-0450

| | |
|---|---|
|  Unit weight | 4,80 |
|  color |  schwarz |
|  piece unit | 200 Pal |
|  accessories | 1 x T-1440 M14 x 40 M |







Meissel - Wechselspitze

Reversible Point / Pointe Reversible

CS0 001 12D

EINSEITIG CS000112D

| | |
|---|--|
|  Unit weight | 1,50 |
|  color |  schwarz |
|  piece unit | 500 Pal |
|  accessories | 1 x G-1240, 523732V 1 x G-1250, 523732AV |







Meissel - Wechselspitze

Reversible Point / Pointe Reversible

CS0 001 12

SOC 00040

| | |
|---|---|
|  Unit weight | 1,42 |
|  color |  schwarz |
|  piece unit | 500 Pal |
|  accessories | 1 x G-1240, 523732V 1 x G-1250, 523732AV |

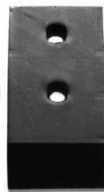





Meissel - Wechselspitze

Reversible Point / Pointe Reversible

CS0 001 12DH

SOC00040 Diamant Hardface

| | |
|---|--|
|  Unit weight | 1,60 |
|  color |  schwarz |
|  piece unit | |
|  accessories | 1 x G-1250, 523732AV 1 x G-1240, 523732V |







Meissel - Wechselspitze

Reversible Point / Pointe Reversible

CS0 001 12H

SOC00040 Hardface

| | |
|---|---|
|  Unit weight | 1,42 |
|  color |  schwarz |
|  piece unit | 500 Pal |
|  accessories | 1 x G-1240, 523732V 1 x G-1250, 523732AV |

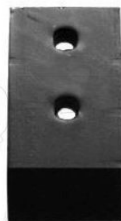





Schare

Share / Soc

CS0 001 26

SOC 00037

| | |
|---|--|
|  Unit weight | 7,80 |
|  color |  schwarz |
|  piece unit | 150 Pal |
|  accessories | 2 x S-1060 10x 60DIN1+ 2 x S-1660 16x60 DIN1+ |







Schare

Share / Soc

CS0 001 11

SOC 00038 - 950

| | |
|---|---|
|  Unit weight | 5,00 |
|  color |  schwarz |
|  piece unit | 150 Pal |
|  accessories | 2 x S-1660 16x60 DIN1+ 2 x S-1060 10x 60DIN1+ |







Scharspitze

Share point / Nez de Soc

CHO 000 50X

80 x 20 -2 hole CP

| | |
|---|--|
|  Unit weight | 1,90 |
|  color |  schwarz |
|  piece unit | 300 Pal |
|  accessories | 1 x B-1285, 548307V 1 x B-1290, 548310V |



Teile passend zu
parts interchangeable
Pièces adaptables pour

RABE

Flügelschare

Winged share / Ailette de Dechaumeur

LINKS / LEFT / GAUCHE

CRO 002 08

GG 51L 6342.50.09

Unit weight 1,45

color blau

piece 500
unit Pal

accessories 2 x B-1030, 547900V

RECHTS / RIGHT / DROITE

CRO 002 07

GG 51 6342.5010



Flügelschare

Winged share / Ailette de Dechaumeur

LINKS / LEFT / GAUCHE

CRO 002 06

GG45L 6342 5003 100x8mm

Unit weight 1,26

color blau

piece 500
unit Pal

accessories 2 x B-1030, 547900V

RECHTS / RIGHT / DROITE

CRO 002 05

GG45R 6342 5004 100x8mm



Flügelschare

Winged share / Ailette de Dechaumeur

LINKS / LEFT / GAUCHE

CRO 002 16

GG45L 6342 5003 120x10MM

Unit weight 1,65

color blau

piece 500
unit Pal

accessories 2 x B-1030, 547900V

RECHTS / RIGHT / DROITE

CRO 002 15

GG45R 6342 5004 120x10MM



Grubberschar

Cultivator Point / Soc double coeur

CV0 045 01

GG 41 44,5mm

Unit weight 3,20

color schwarz

piece 250
unit Pal

accessories 1 x B-1270 2700 2613,
1 x B-1280, 548305V



Teile passend zu
parts interchangeable
Pièces adaptables pour

RAZOL

Flügelschare

Winged share / Ailette de Dechaumeur

LINKS / LEFT / GAUCHE

CR2 000 04

3490G

Unit weight 2,09

color schwarz

piece 350
unit Pal

accessories 2 x C-1235, 523997V

RECHTS / RIGHT / DROITE

CR2 000 03

3490D



Teile passend zu
parts interchangeable
Pièces adaptables pour

REGENT





Flügelschare

Winged share / Ailette de Dechaumeur

LINKS / LEFT / GAUCHE

CB0 001 32

871 1214 2

| | |
|---|--|
|  Unit weight | 2,70 |
|  color |  grün |
|  piece unit | 350 Pal |
|  accessories | 2 x B-1235 - 3015785, 5 |

RECHTS / RIGHT / DROITE

CB0 001 31

871 1214 1

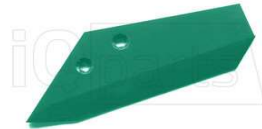





Flügelschare

Winged share / Ailette de Dechaumeur

LINKS / LEFT / GAUCHE

CB0 001 51

AC9 0411 2

| | |
|---|---|
|  Unit weight | 2,00 |
|  color |  grün |
|  piece unit | 150 Pal |
|  accessories | |

RECHTS / RIGHT / DROITE

CB0 001 50

AC9 4111 1







Leitblech

Trashboard / Déflecteur

CB0 001 34

871 1216

| | |
|---|--|
|  Unit weight | 1,80 |
|  color |  grün |
|  piece unit | 500 Pal |
|  accessories | 1 x B-1270 2700 2613, |







Scharspitze

Share point / Nez de Soc

CB0 001 33

871 1215

| | |
|---|---|
|  Unit weight | 1,40 |
|  color |  grün |
|  piece unit | 600 Pal |
|  accessories | 2 x B-1235 - 3015785, 5 |







Scharspitze

Share point / Nez de Soc

CB0 001 57

871.12.20 steil lang

| | |
|---|--|
|  Unit weight | 1,80 |
|  color |  grün |
|  piece unit | 500 Pal |
|  accessories | |

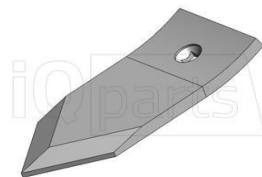





Scharspitze

Share point / Nez de Soc

CB0 001 57H

871.12.20AS Hardface

| | |
|---|---|
|  Unit weight | 1,90 |
|  color |  grün |
|  piece unit | 500 Pal |
|  accessories | |

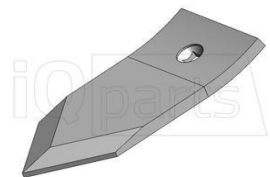





Scharspitze

Share point / Nez de Soc

CB0 001 56

AC7.22.17 90X15

| | |
|---|---|
|  Unit weight | 1,99 |
|  color |  schwarz |
|  piece unit | 500 Pal |
|  accessories | |

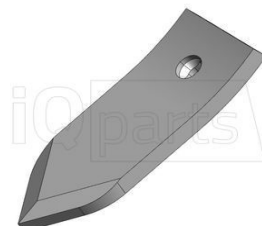





Scharspitze

Share point / Nez de Soc

CB0 001 56H

AC7.22.17AS 90X15 Hardface

| | |
|---|--|
|  Unit weight | 2,10 |
|  color |  schwarz |
|  piece unit | 500 Pal |
|  accessories | |



Teile passend zu
parts interchangeable
Pièces adaptables pour





REGENT

Scharspitze

Share point / Nez de Soc

CB0 001 69

AC8.02.11 MSG 90/15-250

| | | |
|---|---------------|--|
|  | Unit weight | 2,30 |
|  | color |  grün |
|  | piece unit | 500 Pal |
|  | accessories | |





Teile passend zu
parts interchangeable
Pièces adaptables pour

Tiefgrubber

Grindel Leg / Âge

CS0 001 18R

CS0 001 18R 650

| | |
|---|---|
|  Unit weight | 11,60 |
|  color |  schwarz |
|  piece unit | 50 Pal |
|  accessories | |







Grindel Leg / Âge

LINKS / LEFT / GAUCHE

CS0 001 19

CS0 001 19 - 650

| | |
|---|--|
|  Unit weight | 11,60 |
|  color |  schwarz |
|  piece unit | 50 Pal |
|  accessories | |



RECHTS / RIGHT / DROITE

CS0 001 18





CS0 00118 - 650

Grindel Leg / Âge

LINKS / LEFT / GAUCHE

CS0 001 17

CS0 00117 - 950 D16/30

| | |
|---|---|
|  Unit weight | 24,00 |
|  color |  schwarz |
|  piece unit | 30 Pal |
|  accessories | |



RECHTS / RIGHT / DROITE

CS0 001 16





05-02-0447

Grindel Leg / Âge

LINKS / LEFT / GAUCHE

CS0 001 27

CS0 00127 D30/30

| | |
|---|--|
|  Unit weight | 24,20 |
|  color |  schwarz |
|  piece unit | 30 Pal |
|  accessories | |



RECHTS / RIGHT / DROITE

CS0 001 28





DTS 10906

Leitblech Trashboard / Déflecteur

LINKS / LEFT / GAUCHE

CS0 001 15H

CS0 001 15H Hardface

| | |
|---|---|
|  Unit weight | 4,80 |
|  color |  schwarz |
|  piece unit | 200 Pal |
|  accessories | 1 x T-1440 M14 x 40 M |



RECHTS / RIGHT / DROITE

CS0 001 14H





CS0 001 14H Hardface

Leitblech Trashboard / Déflecteur

LINKS / LEFT / GAUCHE

CS0 001 15

CS0 00115 - 950

| | |
|---|--|
|  Unit weight | 4,80 |
|  color |  schwarz |
|  piece unit | 200 Pal |
|  accessories | 1 x T-1440 M14 x 40 M |



RECHTS / RIGHT / DROITE

CS0 001 14





05-02-0450

Leitblech Trashboard / Déflecteur

LINKS / LEFT / GAUCHE

CS0 001 24

CS0 00124 - 650

| | |
|---|---|
|  Unit weight | 2,70 |
|  color |  schwarz |
|  piece unit | 300 Pal |
|  accessories | 1 x T-1440 M14 x 40 M |



RECHTS / RIGHT / DROITE

CS0 001 23





CS0 00123 - 650

Leitblech Trashboard / Déflecteur

LINKS / LEFT / GAUCHE

CS0 001 24H

CS000124 650 Hardface

| | |
|---|--|
|  Unit weight | 3,00 |
|  color |  schwarz |
|  piece unit | 300 Pal |
|  accessories | 1 x T-1440 M14 x 40 M |



RECHTS / RIGHT / DROITE

CS0 001 23H

CS000123 650 Hardface

Teile passend zu
parts interchangeable
Pièces adaptables pour

Tiefgrubber

Leitblech

Trashboard / Déflecteur

LINKS / LEFT / GAUCHE

CS0 001 31

CS000131-950 LONG VERSION

| | | |
|--|-------------|-----------------------|
| | Unit weight | 8,23 |
| | color | ■ schwarz |
| | piece unit | 100 Pal |
| | accessories | 2 x T-1440 M14 x 40 M |

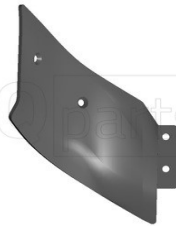

RECHTS / RIGHT / DROITE

CS0 001 30

CS000130- 950 LONG VERSION

Meissel - Wechselspitze

Reversible Point / Pointe Reversible

CS0 001 12H

CS0 001 12H *hardface*

| | | |
|--|-------------|---|
| | Unit weight | 1,42 |
| | color | ■ schwarz |
| | piece unit | 500 Pal |
| | accessories | 1 x G-1240, 523732V 1 x G-1250, 523732AV |

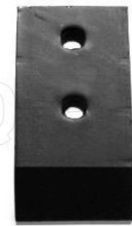

Meissel - Wechselspitze

Reversible Point / Pointe Reversible

CS0 001 12

CS0 00112

| | | |
|--|-------------|---|
| | Unit weight | 1,42 |
| | color | ■ schwarz |
| | piece unit | 500 Pal |
| | accessories | 1 x G-1240, 523732V 1 x G-1250, 523732AV |

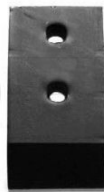

Meissel - Wechselspitze

Reversible Point / Pointe Reversible

CS0 001 12DH

CS0 00112DH *Diamant Hardface*

| | | |
|--|-------------|---|
| | Unit weight | 1,60 |
| | color | ■ schwarz |
| | piece unit | |
| | accessories | 1 x G-1250, 523732AV 1 x G-1240, 523732V |



Meissel - Wechselspitze

Reversible Point / Pointe Reversible

CS0 001 12D

EINSEITIG CS000112D

| | | |
|--|-------------|---|
| | Unit weight | 1,50 |
| | color | ■ schwarz |
| | piece unit | 500 Pal |
| | accessories | 1 x G-1240, 523732V 1 x G-1250, 523732AV |



Schare

Share / Soc

CS0 001 11

CS0 00111 - 950

| | | |
|--|-------------|--|
| | Unit weight | 5,00 |
| | color | ■ schwarz |
| | piece unit | 150 Pal |
| | accessories | 2 x S-1660 16x60 DIN14 2 x S-1060 10x 60DIN14 |



Schare

Share / Soc

CS0 001 25

CS0 00125 - 650

| | | |
|--|-------------|-----------|
| | Unit weight | 4,20 |
| | color | ■ schwarz |
| | piece unit | 150 Pal |
| | accessories | |



Schare

Share / Soc

CS0 001 26

CS0 00126 -950 *reversible*

| | | |
|--|-------------|--|
| | Unit weight | 7,80 |
| | color | ■ schwarz |
| | piece unit | 150 Pal |
| | accessories | 2 x S-1060 10x 60DIN14 2 x S-1660 16x60 DIN14 |



Teile passend zu
parts interchangeable
Pièces adaptables pour

Tiefgrubber

Schare

Share / Soc

CS0 001 29

CS0 00129 650 single reversi

| | | |
|--|-------------|--|
| | Unit weight | 6,07 |
| | color | ■ schwarz |
| | piece unit | 150 Pal |
| | accessories | 2 x S-1060 10x 60DIN1+ 2 x S-1660 16x60 DIN1+ |



Schraube

Screw / Boulon

523 732 V

G-1240

12.9

| | | |
|--|-------------|---------|
| | Unit weight | 0,03 |
| | color | ■ roh |
| | piece unit | 50 Kart |
| | accessories | |



Schraube

Screw / Boulon

523 732 AV

G-1250

12.9

| | | |
|--|-------------|---------|
| | Unit weight | 0,04 |
| | color | ■ roh |
| | piece unit | 50 Kart |
| | accessories | |



Schraube

Screw / Boulon

VIS 140 52

T-1440 M14 x 40 Mu

10.9

| | | |
|--|-------------|---------|
| | Unit weight | 0,05 |
| | color | |
| | piece unit | 50 Kart |
| | accessories | |



Spannstift

Spring / Goupille élastique

716 600 V

S-1060 10x 60DIN1481

| | | |
|--|-------------|---------|
| | Unit weight | 0,01 |
| | color | ■ roh |
| | piece unit | 50 Kart |
| | accessories | |



Spannstift

Spring / Goupille élastique

GOU 160 00

S-1660 16x60 DIN1481

| | | |
|--|-------------|---------|
| | Unit weight | 0,05 |
| | color | |
| | piece unit | 50 Kart |
| | accessories | |







Teile passend zu
parts interchangeable
Pièces adaptables pour

Universal Grubberteile

Gänsefußschar Sweep / Socs Patte d'oie

CVO 080 23

JD 100 100x6MM





| | |
|---|-----------------------|
|  Unit weight | 0,85 |
|  color | ■ schwarz |
|  piece unit | 500 Pal |
|  accessories | 2 x B-1270 2700 2613, |



Gänsefußschar Sweep / Socs Patte d'oie

CVO 080 16

JD 270 270x6MM





| | |
|---|-----------------------|
|  Unit weight | 1,47 |
|  color | ■ schwarz |
|  piece unit | 500 Pal |
|  accessories | 2 x B-1270 2700 2613, |



Gänsefußschar Sweep / Socs Patte d'oie

CVO 080 16V

JD270 x 8MM





| | |
|---|-----------------------|
|  Unit weight | 2,00 |
|  color | ■ roh |
|  piece unit | 500 Pal |
|  accessories | 2 x B-1270 2700 2613, |



Grubberschar Cultivator Point / Soc double coeur

CVO 080 20

100x12mm x480; 45-75; R300; 3L





| | |
|---|--|
|  Unit weight | 0,00 |
|  color | ■ schwarz |
|  piece unit | 250 Pal |
|  accessories | 1 x B-1270 2700 2613, 1 x B-1280, 548305V |



Grubberschar Cultivator Point / Soc double coeur

CVO 080 18

120x12mm x 455; 45-75; R300;3L





| | |
|---|--|
|  Unit weight | 4,00 |
|  color | ■ schwarz |
|  piece unit | 250 Pal |
|  accessories | 1 x B-1270 2700 2613, 1 x B-1280, 548305V |



Grubberschar Cultivator Point / Soc double coeur

CVO 080 19

130x10mm x485; 45-75; R300; 3L



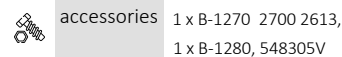

| | |
|---|--|
|  Unit weight | 0,00 |
|  color | ■ schwarz |
|  piece unit | 250 Pal |
|  accessories | 1 x B-1270 2700 2613, 1 x B-1280, 548305V |



Grubberschar Cultivator Point / Soc double coeur

CVO 080 27

50X20 3 Hole LA45



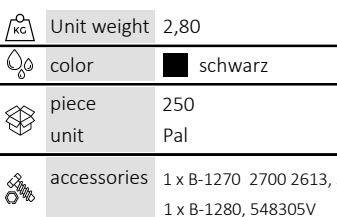

| | |
|---|--|
|  Unit weight | 2,80 |
|  color | ■ schwarz |
|  piece unit | 250 Pal |
|  accessories | 1 x B-1270 2700 2613, 1 x B-1280, 548305V |



Grubberschar Cultivator Point / Soc double coeur

CVO 080 14

55 x 15 x 300; 45-75; R300 3Lo

| | |
|---|--|
|  Unit weight | 0,00 |
|  color | ■ schwarz |
|  piece unit | 250 Pal |
|  accessories | 1 x B-1270 2700 2613, 1 x B-1280, 548305V |

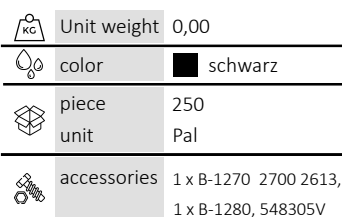

Teile passend zu
parts interchangeable
Pièces adaptables pour

Universal Grubberteile

Grubberschar

Cultivator Point / Soc double coeur

CV0 080 15

55 x 15 x 400; 45-75; R300; 3L

| | |
|-------------|--|
| Unit weight | 0,00 |
| color | schwarz |
| piece unit | 250 Pal |
| accessories | 1 x B-1270 2700 2613, 1 x B-1280, 548305V |



Grubberschar

Cultivator Point / Soc double coeur

CV0 080 30

75X10 2 Hole LA45

| | |
|-------------|--|
| Unit weight | 1,90 |
| color | schwarz |
| piece unit | 250 Pal |
| accessories | 1 x B-1270 2700 2613, 1 x B-1280, 548305V |

Grubberschar

Cultivator Point / Soc double coeur

CV0 080 28

75X10 3 Hole LA45

| | |
|-------------|--|
| Unit weight | 1,90 |
| color | schwarz |
| piece unit | 250 Pal |
| accessories | 1 x B-1270 2700 2613, 1 x B-1280, 548305V |

Grubberschar

Cultivator Point / Soc double coeur

CV0 080 17

80 x 12 mm x 420; 45-75; R300

| | |
|-------------|--|
| Unit weight | 8,84 |
| color | schwarz |
| piece unit | 250 Pal |
| accessories | 1 x B-1270 2700 2613, 1 x B-1280, 548305V |



Grubberschar

Cultivator Point / Soc double coeur

CV0 080 29

90X12 3 HOLE LA45

| | |
|-------------|--|
| Unit weight | 2,40 |
| color | schwarz |
| piece unit | 250 Pal |
| accessories | 1 x B-1270 2700 2613, 1 x B-1280, 548305V |

Grubberschar

Cultivator Point / Soc double coeur

CV0 070 05P

CV0 070 05

| | |
|-------------|--|
| Unit weight | 3,20 |
| color | schwarz |
| piece unit | 250 Pal |
| accessories | 1 x B-1270 2700 2613, 1 x B-1280, 548305V |



Grubberschar

Cultivator Point / Soc double coeur

CV0 080 06P

CV0 080 06

| | |
|-------------|--|
| Unit weight | 3,60 |
| color | schwarz |
| piece unit | 250 Pal |
| accessories | 1 x B-1270 2700 2613, 1 x B-1280, 548305V |



Grubberschar

Cultivator Point / Soc double coeur

CV0 045 01

CV004501 44,5 mm

| | |
|-------------|--|
| Unit weight | 3,20 |
| color | schwarz |
| piece unit | 250 Pal |
| accessories | 1 x B-1270 2700 2613, 1 x B-1280, 548305V |



Teile passend zu
parts interchangeable
Pièces adaptables pour

Universal Grubberteile

Grubberschar Cultivator Point / Soc double coeur

CV0 080 01

CV008001 44,5-75

| | |
|-------------|--|
| Unit weight | 3,15 |
| color | ■ schwarz |
| piece unit | 250 Pal |
| accessories | 1 x B-1270 2700 2613, 1 x B-1280, 548305V |



Grubberschar Cultivator Point / Soc double coeur

CV0 080 17

MOL335 80x12x420-45-75-R300

| | |
|-------------|--|
| Unit weight | 8,84 |
| color | ■ schwarz |
| piece unit | 250 Pal |
| accessories | 1 x B-1270 2700 2613, 1 x B-1280, 548305V |



Grubberschar Cultivator Point / Soc double coeur

CV0 080 18

MOL337 120x12x455-45-75-R300

| | |
|-------------|--|
| Unit weight | 4,00 |
| color | ■ schwarz |
| piece unit | 250 Pal |
| accessories | 1 x B-1270 2700 2613, 1 x B-1280, 548305V |



Grubberschar Cultivator Point / Soc double coeur

CV0 080 19

MOL338 130x10x485-45-75-R300

| | |
|-------------|--|
| Unit weight | 0,00 |
| color | ■ schwarz |
| piece unit | 250 Pal |
| accessories | 1 x B-1270 2700 2613, 1 x B-1280, 548305V |

Grubberschar Cultivator Point / Soc double coeur

CV0 080 20

MOL339 100x12x480-45-75-R300

| | |
|-------------|--|
| Unit weight | 0,00 |
| color | ■ schwarz |
| piece unit | 250 Pal |
| accessories | 1 x B-1270 2700 2613, 1 x B-1280, 548305V |



Grubberstiel Cultivator Tines / Etancon Cultivateur

CV0 045 C3

CV0 045C3 60x25x720

| | |
|-------------|------------|
| Unit weight | 6,54 |
| color | ■ schwarz |
| piece unit | 100 Pal |
| accessories | |



Grubberstiel Cultivator Tines / Etancon Cultivateur

CV0 050 15

CV0 05015 60x25

| | |
|-------------|--------|
| Unit weight | 9,60 |
| color | ■ blau |
| piece unit | Pal |
| accessories | |



Scharfuß Holder / Contre Sep

CB1 000 04

CB1 00004 (70MM)

| | |
|-------------|---------------------|
| Unit weight | 2,80 |
| color | ■ schwarz |
| piece unit | |
| accessories | 1 x B-1260, 548250V |

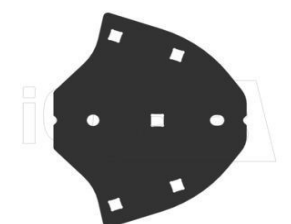





Teile passend zu
parts interchangeable
Pièces adaptables pour

Universal Grubberteile

Scharfuß
Holder / Contre Sep

CV0 045 05

CV004505

| | |
|---|--|
|  Unit weight | 1,65 |
|  color | schwarz |
|  piece unit | 500 Pal |
|  accessories | |



Teile passend zu
parts interchangeable
Pièces adaptables pour

VAEDERSTAD

Flügelshare

Winged share / Ailette de Dechaumeur

LINKS / LEFT / GAUCHE





CV3 000 02

447151

RECHTS / RIGHT / DROITE

CV3 000 01

447150

| | |
|---|---|
|  Unit weight | 1,67 |
|  color |  schwarz |
|  piece unit | 300 Pal |
|  accessories | |



Flügelshare

Winged share / Ailette de Dechaumeur

LINKS / LEFT / GAUCHE





CV3 000 02D

475001 DIAMANT

RECHTS / RIGHT / DROITE

CV3 000 01D

475000 DIAMANT

| | |
|---|--|
|  Unit weight | 1,70 |
|  color |  schwarz |
|  piece unit | |
|  accessories | |







Grubberschar

Cultivator Point / Soc double coeur

CV3 000 05

444897 Topdown 120x12x500

| | |
|---|---|
|  Unit weight | 5,10 |
|  color |  schwarz |
|  piece unit | 150 Pal |
|  accessories | 1 x B-1280, 548305v |







Grubberschar

Cultivator Point / Soc double coeur

CV3 000 03

444898 Topdown 80x12x500

| | |
|---|--|
|  Unit weight | 3,70 |
|  color |  schwarz |
|  piece unit | 250 Pal |
|  accessories | 2 x B-1280, 548305V |







Grubberschar

Cultivator Point / Soc double coeur

CV3 000 04

447152 TOP DOWN 50x20x500

| | |
|---|---|
|  Unit weight | 3,80 |
|  color |  schwarz |
|  piece unit | 250 Pal |
|  accessories | 1 x B-1280, 548305v |

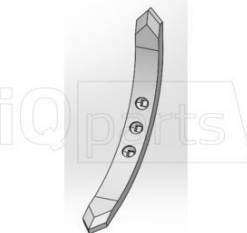





Scharspitze

Share point / Nez de Soc

CV3 000 07

452854 80x12

| | |
|---|--|
|  Unit weight | 1,85 |
|  color |  schwarz |
|  piece unit | 500 Pal |
|  accessories | 1 x B-1270 2700 2613, |







Scharspitze

Share point / Nez de Soc

CV3 000 07H

452854 80x12 hardface

| | |
|---|---|
|  Unit weight | 2,00 |
|  color |  schwarz |
|  piece unit | 500 Pal |
|  accessories | 1 x B-1270 2700 2613, |







Scharspitze

Share point / Nez de Soc

CV3 000 08

457619 120x12

| | |
|---|-----------------------|
|  Unit weight | 2,80 |
|  color | |
|  piece unit | 300 Pal |
|  accessories | 1 x B-1270 2700 2613, |



Teile passend zu
parts interchangeable
Pièces adaptables pour

VAEDERSTAD

Scharspitze
Share point / Nez de Soc

CV3 000 14

155 028 80x15

| | | |
|--|-------------|-----------------------|
| | Unit weight | 2,20 |
| | color | ■ schwarz |
| | piece unit | 400 Pal |
| | accessories | 2 x B-1270 2700 2613, |

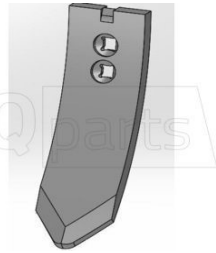

Scharspitze
Share point / Nez de Soc

CV3 000 15

155027 50x15

| | | |
|--|-------------|-----------------------|
| | Unit weight | 1,43 |
| | color | ■ schwarz |
| | piece unit | 500 Pal |
| | accessories | 2 x B-1270 2700 2613, |



Scharspitze
Share point / Nez de Soc

CV3 000 06

457618 50x12

| | | |
|--|-------------|-----------------------|
| | Unit weight | 1,20 |
| | color | ■ schwarz |
| | piece unit | 800 Pal |
| | accessories | 1 x B-1270 2700 2613, |



Scharspitze
Share point / Nez de Soc

CV3 000 15

488441 50x15

| | | |
|--|-------------|-----------------------|
| | Unit weight | 1,43 |
| | color | ■ schwarz |
| | piece unit | 500 Pal |
| | accessories | 2 x B-1270 2700 2613, |



Scharspitze
Share point / Nez de Soc

CV3 000 17DH

498 383 80X20

| | | |
|--|-------------|-----------------------|
| | Unit weight | 2,90 |
| | color | ■ schwarz |
| | piece unit | 300 Pal |
| | accessories | 2 x B-1270 2700 2613, |



Teile passend zu
parts interchangeable
Pièces adaptables pour

Vogel & Noot

Abstreifer Scraper /

G03 210 01

G03221001

| | | |
|--|-------------|-----------|
| | Unit weight | 3,20 |
| | color | ■ schwarz |
| | piece unit | |
| | accessories | |



BLECH Sheet Metal /

U84 104 00

Messer Terradig

| | | |
|--|-------------|------|
| | Unit weight | 4,33 |
| | color | |
| | piece unit | |
| | accessories | |



Federzinke S-Tine / Dent ressort

LINKS / LEFT / GAUCHE

CU1 000 16

G3147002 40x40x640

RECHTS / RIGHT / DROITE

CU1 000 15

G3147001 40x40x640

| | | |
|--|-------------|------------|
| | Unit weight | 30,50 |
| | color | |
| | piece unit | 250 Pal |
| | accessories | |

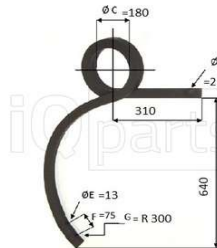

Flügelschare Winged share / Ailette de Dechaumeur

CV0 080 11

400 x 10 mm

| | | |
|--|-------------|-----------|
| | Unit weight | 4,50 |
| | color | ■ schwarz |
| | piece unit | 50 Pal |
| | accessories | |

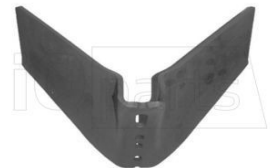

Flügelschare Winged share / Ailette de Dechaumeur

CV0 080 11H

400X10 Hardface

| | | |
|--|-------------|-----------|
| | Unit weight | 4,55 |
| | color | ■ schwarz |
| | piece unit | 50 Pal |
| | accessories | |



Flügelschare Winged share / Ailette de Dechaumeur

CV0 080 05P

CV0 080 05 480 x 10 MM

| | | |
|--|-------------|-----------|
| | Unit weight | 6,70 |
| | color | ■ schwarz |
| | piece unit | 50 Pal |
| | accessories | |



Flügelschare Winged share / Ailette de Dechaumeur

CV0 080 07P

CV0 080 07P 330x10

| | | |
|--|-------------|------------|
| | Unit weight | 4,20 |
| | color | ■ schwarz |
| | piece unit | 200 Pal |
| | accessories | |



Flügelschare Winged share / Ailette de Dechaumeur

CV0 080 08H

CV0 080 08H 270x10 Hardface

| | | |
|--|-------------|-----------|
| | Unit weight | 4,76 |
| | color | ■ schwarz |
| | piece unit | |
| | accessories | |



Teile passend zu
parts interchangeable
Pièces adaptables pour





Vogel & Noot

Flügelschare

Winged share / Ailette de Dechaumeur

CV0 080 08P

CV0 080 08P 270x10

| | |
|---|------------|
|  Unit weight | 3,80 |
|  color | ■ schwarz |
|  piece unit | 250 Pal |
|  accessories | |







Flügelschare

Winged share / Ailette de Dechaumeur

CV0 080 07H

CV0 08007 330x10 Hardface

| | |
|---|-----------|
|  Unit weight | 4,50 |
|  color | ■ schwarz |
|  piece unit | |
|  accessories | |



Flügelschare





Winged share / Ailette de Dechaumeur

LINKS / LEFT / GAUCHE
CV0 045 07

CV004507 370 mm

RECHTS / RIGHT / DROITE
CV0 045 06

CV004506 370 mm

| | |
|---|-----------------------|
|  Unit weight | 1,15 |
|  color | ■ schwarz |
|  piece unit | 700 Pal |
|  accessories | 2 x J-1025 PK000011 M |



Flügelschare





Winged share / Ailette de Dechaumeur

LINKS / LEFT / GAUCHE
CV0 045 09

CV004509 450 mm

RECHTS / RIGHT / DROITE
CV0 045 08

CV004508 450 mm

| | |
|---|-----------------------|
|  Unit weight | 1,31 |
|  color | ■ schwarz |
|  piece unit | 700 Pal |
|  accessories | 2 x J-1025 PK000011 M |



Flügelschare





Winged share / Ailette de Dechaumeur

LINKS / LEFT / GAUCHE
CV0 045 11

CV004511 480 mm

RECHTS / RIGHT / DROITE
CV0 045 10

CV004510 480 mm

| | |
|---|-----------------------|
|  Unit weight | 1,80 |
|  color | ■ schwarz |
|  piece unit | 500 Pal |
|  accessories | 2 x J-1025 PK000011 M |







Flügelschare

Winged share / Ailette de Dechaumeur

CV0 046 00

CV004600 370 mm kpl

| | |
|---|-----------|
|  Unit weight | 4,03 |
|  color | ■ schwarz |
|  piece unit | Pal |
|  accessories | |







Flügelschare

Winged share / Ailette de Dechaumeur

CV0 046 0A

CV00460A 450 mm kpl

| | |
|---|------------|
|  Unit weight | 4,38 |
|  color | ■ schwarz |
|  piece unit | 250 Pal |
|  accessories | |







Flügelschare

Winged share / Ailette de Dechaumeur

CV0 046 0B

CV00460B 480 mm kpl

| | |
|---|------------|
|  Unit weight | 5,50 |
|  color | ■ schwarz |
|  piece unit | 200 Pal |
|  accessories | |



Teile passend zu
parts interchangeable
Pièces adaptables pour

Vogel & Noot

Flügelshare

Winged share / Ailette de Dechaumeur

LINKS / LEFT / GAUCHE





U86 100 04

U86 100 04

RECHTS / RIGHT / DROITE

U86 100 03

U86 100 03

| | |
|---|--|
|  Unit weight | 1,60 |
|  color | ■ rot |
|  piece unit | 300 Pal |
|  accessories | |







Gänsefußschar

Sweep / Socs Patte d'oise

CK4 100 15

X484 5202 200x6

| | |
|---|--|
|  Unit weight | 1,08 |
|  color | ■ schwarz |
|  piece unit | 500 Pal |
|  accessories | 2 x Q-1060 M10x60-10. |



Grindel

Leg / Âge

LINKS / LEFT / GAUCHE





CS0 001 17

U1010001

RECHTS / RIGHT / DROITE

CS0 001 16

U1015001

| | |
|---|--|
|  Unit weight | 24,00 |
|  color | ■ schwarz |
|  piece unit | 30 Pal |
|  accessories | |



Grindel

Leg / Âge

LINKS / LEFT / GAUCHE





CS0 001 17

U1010100

RECHTS / RIGHT / DROITE

CS0 001 16

05-02-0447

| | |
|---|--|
|  Unit weight | 24,00 |
|  color | ■ schwarz |
|  piece unit | 30 Pal |
|  accessories | |

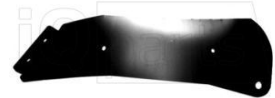





Grubberschar

Cultivator Point / Soc double coeur

X48 450 02

60 x 10 x 318

| | |
|---|--|
|  Unit weight | 1,00 |
|  color | ■ schwarz |
|  piece unit | |
|  accessories | |







Grubberschar

Cultivator Point / Soc double coeur

CV0 070 05P

CV0 070 05

| | |
|---|--|
|  Unit weight | 3,20 |
|  color | ■ schwarz |
|  piece unit | 250 Pal |
|  accessories | 1 x B-1270 2700 2613, 1 x B-1280, 548305V |







Grubberschar

Cultivator Point / Soc double coeur

CV0 080 06P

CV0 080 06

| | |
|---|--|
|  Unit weight | 3,60 |
|  color | ■ schwarz |
|  piece unit | 250 Pal |
|  accessories | 1 x B-1270 2700 2613, 1 x B-1280, 548305V |







Grubberschar

Cultivator Point / Soc double coeur

CV0 045 01

CV004501 44,5 mm

| | |
|---|--|
|  Unit weight | 3,20 |
|  color | ■ schwarz |
|  piece unit | 250 Pal |
|  accessories | 1 x B-1270 2700 2613, 1 x B-1280, 548305V |



Teile passend zu
parts interchangeable
Pièces adaptables pour





Vogel & Noot

Grubberschar

Cultivator Point / Soc double coeur

CV0 080 01

CV008001 44,5-75

| | |
|---|--|
|  Unit weight | 3,15 |
|  color | ■ schwarz |
|  piece unit | 250 Pal |
|  accessories | 1 x B-1270 2700 2613, 1 x B-1280, 548305V |







Grubberschar

Cultivator Point / Soc double coeur

CV0 080 02

CV008002 120x12MM LA70mm

| | |
|---|--|
|  Unit weight | 4,10 |
|  color | ■ schwarz |
|  piece unit | 250 Pal |
|  accessories | 1 x B-1270 2700 2613, 1 x B-1280, 548305V |







Grubberschar

Cultivator Point / Soc double coeur

CV0 080 0C

m. Schneidblech

| | |
|---|--|
|  Unit weight | 6,15 |
|  color | ■ schwarz |
|  piece unit | Pal |
|  accessories | 1 x B-1270 2700 2613, 1 x B-1280, 548305V |







Grubberschar

Cultivator Point / Soc double coeur

CV0 080 0B

m. Seitenblech

| | |
|---|--|
|  Unit weight | 5,70 |
|  color | ■ schwarz |
|  piece unit | Pal |
|  accessories | 1 x B-1270 2700 2613, 1 x B-1280, 548305V |







Grubberstiel

Cultivator Tines / Etancon Cultivateur

PD1 100 H1

PD1 100H1 60x25x720

| | |
|---|------------|
|  Unit weight | 8,40 |
|  color | ■ schwarz |
|  piece unit | 100 Pal |
|  accessories | |







Grubberstiel

Cultivator Tines / Etancon Cultivateur

PD1 100 01

PD110001 60x25x720

| | |
|---|------------|
|  Unit weight | 9,00 |
|  color | ■ schwarz |
|  piece unit | 100 Pal |
|  accessories | |







Grubberstiel

Cultivator Tines / Etancon Cultivateur

PD9 500 H1

PD9 500H1 60x25x820

| | |
|---|------------|
|  Unit weight | 8,80 |
|  color | ■ schwarz |
|  piece unit | 100 Pal |
|  accessories | |



Leitblech

Trashboard / Déflecteur

LINKS / LEFT / GAUCHE





CS0 001 15

U1010003

RECHTS / RIGHT / DROITE

CS0 001 14

05-02-0450

| | |
|---|-----------------------|
|  Unit weight | 4,80 |
|  color | ■ schwarz |
|  piece unit | 200 Pal |
|  accessories | 1 x T-1440 M14 x 40 M |



Teile passend zu
parts interchangeable
Pièces adaptables pour

Vogel & Noot

Leitblech

Trashboard / Déflecteur

LINKS / LEFT / GAUCHE





CS0 001 15H

U1010003H Hardface

RECHTS / RIGHT / DROITE

CS0 001 14H

CS0 001 14H Hardface

| | |
|---|-----------------------|
|  Unit weight | 4,80 |
|  color | ■ schwarz |
|  piece unit | 200 Pal |
|  accessories | 1 x T-1440 M14 x 40 M |







Meissel - Wechselspitze

Reversible Point / Pointe Reversible

CS0 001 22D

CS0 001 22D

| | |
|---|-----------------------|
|  Unit weight | 1,50 |
|  color | ■ rot |
|  piece unit | 500 Pal |
|  accessories | 2 x H-1439, LK000009V |







Meissel - Wechselspitze

Reversible Point / Pointe Reversible

CS0 001 22

CS0 00122

| | |
|---|-----------------------|
|  Unit weight | 1,40 |
|  color | ■ rot |
|  piece unit | 500 Pal |
|  accessories | 2 x H-1439, LK000009V |







MULTIQUICK

MULTIQUICK /

G03 507 00H

80 mm hardface





| | |
|---|-----------|
|  Unit weight | 1,85 |
|  color | ■ schwarz |
|  piece unit | |
|  accessories | |

MULTIQUICK

MULTIQUICK /

G03 500 03H

Multiquick 270 hardface

| | |
|---|-----------|
|  Unit weight | 3,00 |
|  color | ■ schwarz |
|  piece unit | |
|  accessories | |







Schare

Share / Soc

CS0 001 21

CS0 001 21

| | |
|---|--|
|  Unit weight | 4,80 |
|  color | ■ rot |
|  piece unit | 150 Pal |
|  accessories | 2 x S-1660 16x60 DIN1+ 2 x S-1060 10x 60DIN1+ |







Schare

Share / Soc

CS0 001 11

CS000121

| | |
|---|--|
|  Unit weight | 5,00 |
|  color | ■ schwarz |
|  piece unit | 150 Pal |
|  accessories | 2 x S-1660 16x60 DIN1+ 2 x S-1060 10x 60DIN1+ |







Schare

Share / Soc

U30 103 00

U30 10300 Schare SS

| | |
|---|------|
|  Unit weight | 4,20 |
|  color | |
|  piece unit | |
|  accessories | |



Teile passend zu
parts interchangeable
Pièces adaptables pour





Vogel & Noot

Schare

Share / Soc

U86 100 02P

U86 100 02P 70x25x540-LA65

| | |
|---|--|
|  Unit weight | 6,85 |
|  color | ■ rot |
|  piece unit | 150 Pal |
|  accessories | 3 x B-1280, 548305V |







Schare

Share / Soc

U86 100 07

U86 100 07

| | |
|---|--|
|  Unit weight | 6,60 |
|  color | ■ rot |
|  piece unit | |
|  accessories | 1 x B-1280, 548305V |







Schare

Share / Soc

U86 200 02P

U86 200 02P 50x25x540-LA65

| | |
|---|--|
|  Unit weight | 4,84 |
|  color | ■ rot |
|  piece unit | 150 Pal |
|  accessories | 3 x B-1280, 548305V |







Scharfuß

Holder / Contre Sep

CV0 045 05

CV004505

| | |
|---|--|
|  Unit weight | 1,65 |
|  color | ■ schwarz |
|  piece unit | 500 Pal |
|  accessories | |







Sohlenspitze

sole tip /

U86 100 07D

U86 100 07D

| | |
|---|--|
|  Unit weight | 1,89 |
|  color | ■ rot |
|  piece unit | |
|  accessories | 2 x H-1439, LK000009V |







Streichschiene

Tailpress / Rallonge de Versoir

RECHTS / RIGHT / DROITE

PD6 420 00

| | |
|---|--|
|  Unit weight | 5,30 |
|  color | ■ schwarz |
|  piece unit | |
|  accessories | |







Streichschiene

Tailpress / Rallonge de Versoir

LINKS / LEFT / GAUCHE

PD6 421 00

| | |
|---|--|
|  Unit weight | 5,00 |
|  color | ■ schwarz |
|  piece unit | |
|  accessories | |







Verschleißblech

Wear Plate /

U86 103 00

U86 103 00

| | |
|---|--|
|  Unit weight | 4,12 |
|  color | ■ rot |
|  piece unit | |
|  accessories | |

Teile passend zu
parts interchangeable
Pièces adaptables pour





Vogel & Noot

ZINKE

Tine leg /

PQ7 340 03

PQ7 340 03

| | |
|---|---|
|  Unit weight | 2,00 |
|  color | ■ schwarz |
|  piece unit | Pal |
|  accessories | |







ZINKE

Tine leg /

G05 790 02

Striegelzinke

| | |
|---|------|
|  Unit weight | 1,17 |
|  color | |
|  piece unit | |
|  accessories | |







ZINKE

Tine leg /

U84 100 01

Zinke Terradig XS

| | |
|---|---|
|  Unit weight | 34,01 |
|  color | ■ rot |
|  piece unit | 30 |
|  accessories | Pal |

Teile passend zu
parts interchangeable
Pièces adaptables pour





Widder

Flügelschare

Winged share / Ailette de Dechaumeur

CW0 000 07

92340

| | |
|---|---|
|  Unit weight | 6,30 |
|  color | ■ schwarz |
|  piece unit | |
|  accessories | |





Lined writing area consisting of 20 horizontal lines.

KREISELEGGE

POWER HARROW

HERSE ROTATIVE

РОТАЦИОННЫЕ БОРОНЫ

GRADAS ROTATIVAS

ERPICE

FORGÓBORONÁK

BRONY AKTYWNE

ROTACIONE DRLJAČE

VRTAVKASTE BRANE

GRAPE ROTATIVE



Teile passend zu
parts interchangeable
Pièces adaptables pour

AMAZONE

Eggenzinke

Harrow Tine / Dent de herse

LINKS / LEFT / GAUCHE

CA3 000 24

952 775

RECHTS / RIGHT / DROITE

CA3 000 23

952 774

| | | |
|--|-------------|-----------|
| | Unit weight | 3,90 |
| | color | ■ schwarz |
| | piece unit | 200 Pal |
| | accessories | |



Eggenzinke

Harrow Tine / Dent de herse

LINKS / LEFT / GAUCHE

CA3 000 20

657 5300 120x15

RECHTS / RIGHT / DROITE

CA3 000 19

657 4300 120x15

| | | |
|--|-------------|-----------|
| | Unit weight | 3,10 |
| | color | ■ schwarz |
| | piece unit | 200 Pal |
| | accessories | |



Eggenzinke

Harrow Tine / Dent de herse

LINKS / LEFT / GAUCHE

CA3 000 20D

657 5300 Diamant

RECHTS / RIGHT / DROITE

CA3 000 19D

657 4300 Diamant

| | | |
|--|-------------|-----------|
| | Unit weight | 3,35 |
| | color | ■ schwarz |
| | piece unit | 200 Pal |
| | accessories | |



Eggenzinke

Harrow Tine / Dent de herse

LINKS / LEFT / GAUCHE

CA3 000 20H

657 5300 Hardface

RECHTS / RIGHT / DROITE

CA3 000 19H

657 4300 Hardface

| | | |
|--|-------------|-----------|
| | Unit weight | 3,10 |
| | color | ■ schwarz |
| | piece unit | 200 Pal |
| | accessories | |



Eggenzinke

Harrow Tine / Dent de herse

LINKS / LEFT / GAUCHE

CA3 000 27

954 427 60x18

RECHTS / RIGHT / DROITE

CA3 000 28

954 426 60x18

| | | |
|--|-------------|-----------|
| | Unit weight | 0,00 |
| | color | ■ schwarz |
| | piece unit | Pal |
| | accessories | |



Eggenzinke

Harrow Tine / Dent de herse

LINKS / LEFT / GAUCHE

CA3 000 26

967 496 120x15

RECHTS / RIGHT / DROITE

CA3 000 25

967 495 120x15

| | | |
|--|-------------|-----------|
| | Unit weight | 3,66 |
| | color | ■ schwarz |
| | piece unit | 200 Pal |
| | accessories | |



Eggenzinke

Harrow Tine / Dent de herse

LINKS / LEFT / GAUCHE

CA3 000 29

KE950 789S 60x15

RECHTS / RIGHT / DROITE

CA3 000 30

KE950 788S 60x15

| | | |
|--|-------------|-----------|
| | Unit weight | 0,00 |
| | color | ■ schwarz |
| | piece unit | Pal |
| | accessories | |



Teile passend zu
parts interchangeable
Pièces adaptables pour

Breviglieri

| | |
|----------------------------|-------------------------|
| ZINKE Tine leg / | |
| LINKS / LEFT / GAUCHE | RECHTS / RIGHT / DROITE |
| E01 001 29 | E01 001 30 |
| SUPERFAST | SUPERFAST |

| | |
|-------------|------|
| Unit weight | 2,46 |
| color | |
| piece unit | |
| accessories | |



Teile passend zu
parts interchangeable
Pièces adaptables pour

GASPARDO

| | |
|--------------------------------|--|
| Abstreifer Scraper / | |
| CM3 000 08 | |
| M271 00539 95X90X4 | |

| | |
|-------------|-----------|
| Unit weight | 0,25 |
| color | ■ schwarz |
| piece unit | Pal |
| accessories | |



| | |
|--|-------------------------|
| Eggenzinke Harrow Tine / Dent de herse | |
| LINKS / LEFT / GAUCHE | RECHTS / RIGHT / DROITE |
| CM3 000 03 | CM3 000 02 |
| M271 00210 90X12 | M271 00209 90X12 |

| | |
|-------------|-----------|
| Unit weight | 0,00 |
| color | ■ schwarz |
| piece unit | Pal |
| accessories | |



| | |
|--|-------------------------|
| Eggenzinke Harrow Tine / Dent de herse | |
| LINKS / LEFT / GAUCHE | RECHTS / RIGHT / DROITE |
| CM3 000 05 | CM3 000 04 |
| M361 00211 100X12 | M361 00210 100X12 |

| | |
|-------------|-----------|
| Unit weight | 0,00 |
| color | ■ schwarz |
| piece unit | Pal |
| accessories | |



| | |
|--|-------------------------|
| Eggenzinke Harrow Tine / Dent de herse | |
| LINKS / LEFT / GAUCHE | RECHTS / RIGHT / DROITE |
| CM3 000 07 | CM3 000 06 |
| M361 00216 100X15 | M361 00215 100X15 |

| | |
|-------------|------|
| Unit weight | 0,00 |
| color | |
| piece unit | Pal |
| accessories | |



Teile passend zu
parts interchangeable
Pièces adaptables pour

KUHN

| | | |
|--|-------------------------|-----------|
| Eggenzinke Harrow Tine / Dent de herse | | HR |
| LINKS / LEFT / GAUCHE | RECHTS / RIGHT / DROITE | |
| CK3 001 43 | CK3 001 44 | |
| <i>525 395 110x16</i> | <i>525 394 110x16</i> | |

| | |
|-------------|-----------|
| Unit weight | 0,00 |
| color | ■ schwarz |
| piece unit | Pal |
| accessories | |



| | |
|--|-------------------------|
| Eggenzinke Harrow Tine / Dent de herse | |
| LINKS / LEFT / GAUCHE | RECHTS / RIGHT / DROITE |
| CK3 001 47 | CK3 001 48 |
| <i>525 495 110x12</i> | <i>525 494 110x12</i> |

| | |
|-------------|-----------|
| Unit weight | 0,00 |
| color | ■ schwarz |
| piece unit | Pal |
| accessories | |



| | |
|--|-------------------------|
| Eggenzinke Harrow Tine / Dent de herse | |
| LINKS / LEFT / GAUCHE | RECHTS / RIGHT / DROITE |
| CK3 001 49 | CK3 001 50 |
| <i>K250 0071 110x14</i> | <i>K250 0081 110x14</i> |

| | |
|-------------|-----------|
| Unit weight | 0,00 |
| color | ■ schwarz |
| piece unit | Pal |
| accessories | |

| | |
|--|-------------------------|
| Eggenzinke Harrow Tine / Dent de herse | |
| LINKS / LEFT / GAUCHE | RECHTS / RIGHT / DROITE |
| CK3 001 45 | CK3 001 46 |
| <i>K250 0090 120x16</i> | <i>K250 0100 120x16</i> |

| | |
|-------------|-----------|
| Unit weight | 0,00 |
| color | ■ schwarz |
| piece unit | Pal |
| accessories | |



Teile passend zu
parts interchangeable
Pièces adaptables pour

Kverneland

Eggenzinke

Harrow Tine / Dent de herse

LINKS / LEFT / GAUCHE

CK0 001 35

44 010 151 100x18

RECHTS / RIGHT / DROITE

CK0 001 36

44 010 150 100x18

| | |
|-------------|---------|
| Unit weight | 0,00 |
| color | schwarz |
| piece unit | Pal |
| accessories | |



Eggenzinke

Harrow Tine / Dent de herse

LINKS / LEFT / GAUCHE

CK0 001 37

46 010 151 100x15

RECHTS / RIGHT / DROITE

CK0 001 38

46 010 150 100x15

| | |
|-------------|---------|
| Unit weight | 0,00 |
| color | schwarz |
| piece unit | Pal |
| accessories | |



Eggenzinke

Harrow Tine / Dent de herse

LINKS / LEFT / GAUCHE

CK0 001 39

E040 146 110x15

RECHTS / RIGHT / DROITE

CK0 001 40

E030 146 110x15

| | |
|-------------|---------|
| Unit weight | 0,00 |
| color | schwarz |
| piece unit | Pal |
| accessories | |



Teile passend zu
parts interchangeable
Pièces adaptables pour

Lemken

Eggenzinke

Harrow Tine / Dent de herse

LINKS / LEFT / GAUCHE

CL1 002 27

337 7012 110x18

RECHTS / RIGHT / DROITE

CL1 002 26

337 7013 110x18

| | |
|-------------|---------|
| Unit weight | 0,00 |
| color | schwarz |
| piece unit | Pal |
| accessories | |

Eggenzinke

Harrow Tine / Dent de herse

LINKS / LEFT / GAUCHE

CL1 002 25

337 7023 110x15

RECHTS / RIGHT / DROITE

CL1 002 24

337 7022 110x15

| | |
|-------------|------|
| Unit weight | 0,00 |
| color | blau |
| piece unit | Pal |
| accessories | |







Teile passend zu
parts interchangeable
Pièces adaptables pour

Maschio

Abstreifer
Scraper /

CM3 000 08

M271 00539 95x90x4

| | |
|---|---|
|  Unit weight | 0,25 |
|  color | ■ schwarz |
|  piece unit | Pal |
|  accessories | |







Eggenzinke
Harrow Tine / Dent de herse

LINKS / LEFT / GAUCHE

CM3 000 03

M271 00210 90x12

| | |
|---|---|
|  Unit weight | 0,00 |
|  color | ■ schwarz |
|  piece unit | Pal |
|  accessories | |

RECHTS / RIGHT / DROITE

CM3 000 02

M271 00209 90X12







Eggenzinke
Harrow Tine / Dent de herse

LINKS / LEFT / GAUCHE

CM3 000 05

M361 00211 100x12

| | |
|---|---|
|  Unit weight | 0,00 |
|  color | ■ schwarz |
|  piece unit | Pal |
|  accessories | |



RECHTS / RIGHT / DROITE

CM3 000 04





M361 00210 100X12

Eggenzinke
Harrow Tine / Dent de herse

LINKS / LEFT / GAUCHE

CM3 000 07

M361 00216 100x15

| | |
|---|------|
|  Unit weight | 0,00 |
|  color | |
|  piece unit | Pal |
|  accessories | |

RECHTS / RIGHT / DROITE

CM3 000 06

M361 00215 100X15



Teile passend zu
parts interchangeable
Pièces adaptables pour

RABE

| Eggenzinke Harrow Tine / Dent de herse | |
|---|--|
| LINKS / LEFT / GAUCHE | RECHTS / RIGHT / DROITE |
| CRO 002 41 8404.50.14 100x15 | CRO 002 40 8404.50.13 100x15 |

| | |
|-------------|---------|
| Unit weight | 0,00 |
| color | schwarz |
| piece unit | Pal |
| accessories | |

| Eggenzinke Harrow Tine / Dent de herse | |
|---|--|
| LINKS / LEFT / GAUCHE | RECHTS / RIGHT / DROITE |
| CRO 002 45 8423.18.03 100x18 | CRO 002 44 8423.18.01 100x18 |

| | |
|-------------|---------|
| Unit weight | 0,00 |
| color | schwarz |
| piece unit | Pal |
| accessories | |

| Eggenzinke Harrow Tine / Dent de herse | |
|---|--|
| LINKS / LEFT / GAUCHE | RECHTS / RIGHT / DROITE |
| CRO 002 43 8437.77.02 100x16 | CRO 002 42 8437.77.01 100x16 |

| | |
|-------------|---------|
| Unit weight | 0,00 |
| color | schwarz |
| piece unit | |
| accessories | |

Teile passend zu
parts interchangeable
Pièces adaptables pour

Spatenrollenmesser

| Spatenrollenmesser Rotating cultivator blades / | |
|--|---------------------------------|
| LINKS / LEFT / GAUCHE | RECHTS / RIGHT / DROITE |
| CV0 000 32 SRM 400 LI | CV0 000 31 SRM 400 RE |

| | |
|-------------|------------|
| Unit weight | 2,10 |
| color | schwarz |
| piece unit | 500 Pal |
| accessories | |



Teile passend zu
parts interchangeable
Pièces adaptables pour

Tulip

TU7 05- 930-028-00

705-930-028-001

| | |
|-------------|------|
| Unit weight | 0,00 |
| color | |
| piece unit | |
| accessories | |

Eggenzinke
Harrow Tine / Dent de herse

LINKS / LEFT / GAUCHE

TU1 .16 99.0111.0

1.1699.0111.0

RECHTS / RIGHT / DROITE

TU1 .16 99.0112.0

1.1699.0112.0

| | |
|-------------|------|
| Unit weight | 0,00 |
| color | |
| piece unit | |
| accessories | |



Eggenzinke
Harrow Tine / Dent de herse

LINKS / LEFT / GAUCHE

TU1 .16 99.0127.0

1.1699.0127.0

RECHTS / RIGHT / DROITE

TU1 .16 99.0128.0

1.1699.0128.0

| | |
|-------------|------|
| Unit weight | 0,00 |
| color | |
| piece unit | |
| accessories | |

RAD
WHEEL /

TU1 .16 99.0560.8

1.1699.0560.8

| | |
|-------------|------|
| Unit weight | 0,00 |
| color | |
| piece unit | |
| accessories | |

Stange
rod /

TU1 .16 07.0148.0

1.1607.0148.0

| | |
|-------------|------|
| Unit weight | 0,00 |
| color | |
| piece unit | |
| accessories | |

Teile passend zu
parts interchangeable
Pièces adaptables pour

VIGOLO

Eggenzinke

Harrow Tine / Dent de herse

LINKS / LEFT / GAUCHE

E02 014 4

1730

RECHTS / RIGHT / DROITE

E01 014 4

1730

| | |
|-------------|-----------|
| Unit weight | 1,80 |
| color | ■ schwarz |
| piece unit | |
| accessories | |



Eggenzinke

Harrow Tine / Dent de herse

041 750 000

TM600

| | |
|-------------|------|
| Unit weight | 1,92 |
| color | |
| piece unit | |
| accessories | |



Eggenzinke

Harrow Tine / Dent de herse

041 750 010

TM600

| | |
|-------------|------|
| Unit weight | 1,92 |
| color | |
| piece unit | |
| accessories | |



ZINKE

Tine leg /

LINKS / LEFT / GAUCHE

931 010 038

100x15x320

RECHTS / RIGHT / DROITE

931 010 037

100x15x320

| | |
|-------------|------|
| Unit weight | 2,00 |
| color | |
| piece unit | |
| accessories | |



ZINKE

Tine leg /

LINKS / LEFT / GAUCHE

931 010 040

110x15x330

RECHTS / RIGHT / DROITE

931 010 039

110x15x330

| | |
|-------------|------|
| Unit weight | 2,00 |
| color | |
| piece unit | |
| accessories | |







Teile passend zu
parts interchangeable
Pièces adaptables pour

Vogel & Noot

Abstreifer
Scraper /





KZ2 230 01

| | |
|---|------|
|  Unit weight | 0,47 |
|  color | |
|  piece unit | |
|  accessories | |



Abstreifer
Scraper /





KZ7 009 00

| | |
|---|------|
|  Unit weight | 3,83 |
|  color | |
|  piece unit | |
|  accessories | |



Abstreifer
Scraper /

KZ7 011 00





| | |
|---|------|
|  Unit weight | 3,83 |
|  color | |
|  piece unit | |
|  accessories | |



Abstreifer
Scraper /

317 897 4

100 Eurotill





| | |
|---|------|
|  Unit weight | 0,20 |
|  color | |
|  piece unit | |
|  accessories | |



Abstreifer
Scraper /

KZ7 010 00

3-Fach geschw.





| | |
|---|------|
|  Unit weight | 7,50 |
|  color | |
|  piece unit | |
|  accessories | |



Abstreifer
Scraper /

KZ2 224 00

3M geschw





| | |
|---|-------|
|  Unit weight | 87,88 |
|  color | |
|  piece unit | |
|  accessories | |



Abstreifer
Scraper /

931 090 005

75x4x130





| | |
|---|------|
|  Unit weight | 0,30 |
|  color | |
|  piece unit | |
|  accessories | |



Abstreifer
Scraper /

151 190 000

95

| | |
|---|------|
|  Unit weight | 0,30 |
|  color | |
|  piece unit | |
|  accessories | |







Teile passend zu
parts interchangeable
Pièces adaptables pour

Vogel & Noot

Abstreifer Scraper /

KZ7 025 01

Abstreifer





| | |
|---|------|
|  Unit weight | 0,33 |
|  color | |
|  piece unit | |
|  accessories | |



Abstreifer Scraper /

KZ7 062 01

Abstreifer

| | |
|---|------|
|  Unit weight | 0,42 |
|  color | |
|  piece unit | |
|  accessories | |



Eggenzinke

Harrow Tine / Dent de herse

LINKS / LEFT / GAUCHE





KZ2 000 02

KZ2 02

RECHTS / RIGHT / DROITE

KZ2 000 01

KZ2 01

| | |
|---|------------|
|  Unit weight | 3,30 |
|  color | ■ schwarz |
|  piece unit | 200 Pal |
|  accessories | |



Eggenzinke

Harrow Tine / Dent de herse

LINKS / LEFT / GAUCHE





E02 014 4

1730

RECHTS / RIGHT / DROITE

E01 014 4

1730

| | |
|---|-----------|
|  Unit weight | 1,80 |
|  color | ■ schwarz |
|  piece unit | |
|  accessories | |



Eggenzinke

Harrow Tine / Dent de herse

LINKS / LEFT / GAUCHE





KZ2 000 02D

KZ2 02 Diamant

RECHTS / RIGHT / DROITE

KZ2 000 01D

KZ2 01 Diamant

| | |
|---|------------|
|  Unit weight | 3,40 |
|  color | ■ schwarz |
|  piece unit | 200 Pal |
|  accessories | |







Eggenzinke

Harrow Tine / Dent de herse

KZ4 000 01

KZ4 000 01

| | |
|---|------|
|  Unit weight | 2,96 |
|  color | |
|  piece unit | |
|  accessories | |







Eggenzinke

Harrow Tine / Dent de herse

LINKS / LEFT / GAUCHE

KZ4 000 02

KZ4 000 02

| | |
|---|------|
|  Unit weight | 2,96 |
|  color | |
|  piece unit | |
|  accessories | |



Eggenzinke

Harrow Tine / Dent de herse

LINKS / LEFT / GAUCHE





KZ4 000 04

KZ4 000 04

RECHTS / RIGHT / DROITE

KZ4 000 03

KZ4 000 03

| | |
|---|------|
|  Unit weight | 2,95 |
|  color | |
|  piece unit | |
|  accessories | |



Teile passend zu
parts interchangeable
Pièces adaptables pour

Vogel & Noot

Eggenzinke

Harrow Tine / Dent de herse

LINKS / LEFT / GAUCHE





KZ4 000 06D

KZ4 000 06D Diamant

RECHTS / RIGHT / DROITE

KZ4 000 05D

KZ4 000 05D

| | |
|---|------------|
|  Unit weight | 3,30 |
|  color | ■ schwarz |
|  piece unit | 200 Pal |
|  accessories | |







Eggenzinke

Harrow Tine / Dent de herse

041 750 010

TM600

| | |
|---|------|
|  Unit weight | 1,92 |
|  color | |
|  piece unit | |
|  accessories | |







Eggenzinke

Harrow Tine / Dent de herse

041 750 000

TM600

| | |
|---|------|
|  Unit weight | 1,92 |
|  color | |
|  piece unit | |
|  accessories | |



ZINKE

Tine leg /

LINKS / LEFT / GAUCHE





931 010 038

100x15x320

RECHTS / RIGHT / DROITE

931 010 037

100x15x320

| | |
|---|------|
|  Unit weight | 2,00 |
|  color | |
|  piece unit | |
|  accessories | |



ZINKE

Tine leg /

LINKS / LEFT / GAUCHE





931 010 040

110x15x330

RECHTS / RIGHT / DROITE

931 010 039

110x15x330

| | |
|---|------|
|  Unit weight | 2,00 |
|  color | |
|  piece unit | |
|  accessories | |



ZINKE

Tine leg /

LINKS / LEFT / GAUCHE





931 010 046

90X14X320 HYDRO N

RECHTS / RIGHT / DROITE

931 010 045

MESSERZ. 90X14X320

| | |
|---|------|
|  Unit weight | 2,15 |
|  color | |
|  piece unit | |
|  accessories | |



ZINKE

Tine leg /

LINKS / LEFT / GAUCHE





E01 001 29

EUROTILL SWL

RECHTS / RIGHT / DROITE

E01 001 30

SUPERFAST

| | |
|---|------|
|  Unit weight | 2,46 |
|  color | |
|  piece unit | |
|  accessories | |



BODENFRÄSE

ROTARY CULTIVATOR
FRAISE ETACTIL D'ENTRETIEN
ПОЧВЕННЫЕ ФРЕЗЫ
FRESADORAS
ERPICE ROTANTE
ÁSÓBORONÁK
GLEBOGRYZARKA
FREZE
FREZE ZA OBDELAVO TAL
FREZA ROTATIVA



Teile passend zu
parts interchangeable
Pièces adaptables pour

AVR

FRÄSHAKEN
RIDGER TINE /

CA4 000 01D

011766 DIAMANT

| | | |
|--|-------------|-----------|
| | Unit weight | 1,15 |
| | color | ■ schwarz |
| | piece unit | 800 Pal |
| | accessories | |



FRÄSHAKEN
RIDGER TINE /

CA4 000 02D

RS18197 DIAMANT

| | | |
|--|-------------|-----------|
| | Unit weight | 0,81 |
| | color | ■ schwarz |
| | piece unit | 800 Pal |
| | accessories | |



Teile passend zu
parts interchangeable
Pièces adaptables pour

BASELIER

FRÄSHAKEN
RIDGER TINE /

CB3 000 01D

14FK090041 40X10 LA80

| | | |
|--|-------------|-----------|
| | Unit weight | 0,92 |
| | color | ■ schwarz |
| | piece unit | 800 Pal |
| | accessories | |



Teile passend zu
parts interchangeable
Pièces adaptables pour

Gutzwiller

MESSER
KNIFE /

CV0 060 23D

P027710 Diamant

| | | |
|--|-------------|-----------|
| | Unit weight | 0,46 |
| | color | ■ schwarz |
| | piece unit | 1 000 Pal |
| | accessories | |

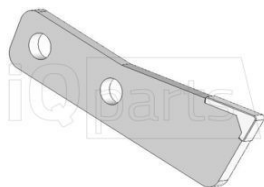

Teile passend zu
parts interchangeable
Pièces adaptables pour

Rumptstad

FRÄSHAKEN
RIDGER TINE /

CA4 000 02D

RS18197 DIAMANT

| | | |
|--|-------------|-----------|
| | Unit weight | 0,81 |
| | color | ■ schwarz |
| | piece unit | 800 Pal |
| | accessories | |



Teile passend zu
parts interchangeable
Pièces adaptables pour

Tulip

KLAPPE
FLAP /

TU7 40- 934-004T

740-934-004T

| | | |
|--|-------------|------|
| | Unit weight | 0,00 |
| | color | |
| | piece unit | |
| | accessories | |

PFLUG

PLOUGH

CHARRUE

ПЛУГИ

ARADOS

ARATRO

ΕΚΕΚ

PŁUGI

PLUG

PLUGI

PLUGURI



Teile passend zu
parts interchangeable
Pièces adaptables pour

Agrolux

Düngereinlegeblech

Skimmer Board / Versoirs de Rasette

LINKS / LEFT / GAUCHE





CP2 000 82

91 804

RECHTS / RIGHT / DROITE

CP2 000 81

91 803

| | |
|---|--|
|  Unit weight | 2,05 |
|  color | ■ rot |
|  piece unit | 300 Pal |
|  accessories | 2 x C-1235, 523997V |



Mollblech -Streichblech

Mouldboard / Versoir

LINKS / LEFT / GAUCHE





CP2 000 40

94 595

RECHTS / RIGHT / DROITE

CP2 000 39

94 594

| | |
|---|--|
|  Unit weight | 18,80 |
|  color | ■ rot |
|  piece unit | 50 Pal |
|  accessories | 8 x C-1235, 523997V |



XL

Scharblatt

Wing / Aileron

UC; FC

LINKS / LEFT / GAUCHE

CP2 000 30

85 194





14"

RECHTS / RIGHT / DROITE

CP2 000 29

85 004

14"

| | |
|---|--|
|  Unit weight | 3,00 |
|  color | ■ rot |
|  piece unit | 200 Pal |
|  accessories | 2 x C-1235, 523997V |



Scharblatt

Wing / Aileron

V; FK

LINKS / LEFT / GAUCHE

CP2 000 26

85 381





14"

RECHTS / RIGHT / DROITE

CP2 000 25

85 383

14"

| | |
|---|--|
|  Unit weight | 4,35 |
|  color | ■ rot |
|  piece unit | 200 Pal |
|  accessories | 2 x C-1235, 523997V |



Scharblatt

Wing / Aileron

V; FK

LINKS / LEFT / GAUCHE

CP2 000 50

85 382





16"

RECHTS / RIGHT / DROITE

CP2 000 49

85 384

16"

| | |
|---|--|
|  Unit weight | 4,50 |
|  color | ■ rot |
|  piece unit | 200 Pal |
|  accessories | 2 x C-1235, 523997V |



Scharblatt

Wing / Aileron

XL

LINKS / LEFT / GAUCHE

CP2 000 52

94 599





14"

RECHTS / RIGHT / DROITE

CP2 000 51

94 598

14"

| | |
|---|--|
|  Unit weight | 3,60 |
|  color | ■ rot |
|  piece unit | 200 Pal |
|  accessories | 2 x C-1235, 523997V |



Scharblatt

Wing / Aileron

XL

LINKS / LEFT / GAUCHE

CP2 000 54

94 601





16"

RECHTS / RIGHT / DROITE

CP2 000 53

94 600

16"

| | |
|---|--|
|  Unit weight | 4,05 |
|  color | ■ rot |
|  piece unit | 200 Pal |
|  accessories | 2 x C-1235, 523997V |



Scharblatt

Wing / Aileron

XL

LINKS / LEFT / GAUCHE

CP2 000 36

94 603





18"

RECHTS / RIGHT / DROITE

CP2 000 35

94 602

18"

| | |
|---|--|
|  Unit weight | 4,60 |
|  color | ■ rot |
|  piece unit | 200 Pal |
|  accessories | 2 x C-1235, 523997V |



Teile passend zu
parts interchangeable
Pièces adaptables pour

Agrolux

Verschleißstück - Streichblech - Vorderteil **XL**
Wearing part - Moulboard - Front part / Etrave

| | |
|-----------------------|-------------------------|
| LINKS / LEFT / GAUCHE | RECHTS / RIGHT / DROITE |
| CP2 000 38 | CP2 000 37 |
| 94 597 | 94 596 |

| | |
|-------------|---------------------|
| Unit weight | 1,35 |
| color | rot |
| piece | 500 |
| unit | Pal |
| accessories | 2 x C-1235, 523997V |



Teile passend zu
parts interchangeable
Pièces adaptables pour

BUGNOT

Meissel - Wechselspitze
Reversible Point / Pointe Reversible

| | |
|-----------------------|-------------------------|
| LINKS / LEFT / GAUCHE | RECHTS / RIGHT / DROITE |
| CB2 000 02 | CB2 000 01 |
| 6035 | 6034 |

| | |
|-------------|---------------------|
| Unit weight | 1,30 |
| color | schwarz |
| piece | 500 |
| unit | Pal |
| accessories | 2 x G-1234, 523998V |



Teile passend zu
parts interchangeable
Pièces adaptables pour

DIN-Teile





Anlage

Landside / Contre-Sep

RECHTS / RIGHT / DROITE

CV0 000 63

K 1063

| | |
|---|---|
|  Unit weight | 2,65 |
|  color |  rot |
|  piece unit | 400 Pal |
|  accessories | 2 x D-1235 11014D123 1 x A-1640, 548350V |







Anlage

Landside / Contre-Sep

LINKS / LEFT / GAUCHE

CV0 000 68

K 1093

| | |
|---|--|
|  Unit weight | 3,60 |
|  color |  rot |
|  piece unit | 250 Pal |
|  accessories | 2 x D-1235 11014D123 1 x A-1640, 548350V |



RECHTS / RIGHT / DROITE

CV0 000 67

K 1083





Düngereinlegeschar

Skim Point / Soc de Rasette

LINKS / LEFT / GAUCHE

CV0 000 08

FR3

| | |
|---|---|
|  Unit weight | 0,50 |
|  color |  rot |
|  piece unit | 1 000 Pal |
|  accessories | 1 x B-1035 608D1035N |



RECHTS / RIGHT / DROITE

CV0 000 07

FR3





Mollblech -Streichblech

Mouldboard / Versoir

LINKS / LEFT / GAUCHE

PK2 002 02B

HST 1090 CV000036

| | |
|---|--|
|  Unit weight | 9,50 |
|  color |  rot |
|  piece unit | 100 Pal |
|  accessories | 6 x D-1235 11014D123 |



RECHTS / RIGHT / DROITE

PK2 001 02B

HST 1080 CV000035





Mollblech -Streichblech

Mouldboard / Versoir

LINKS / LEFT / GAUCHE

PK3 002 02BP

HST 1130 CV0 00038

| | |
|---|---|
|  Unit weight | 11,50 |
|  color |  rot |
|  piece unit | 50 Pal |
|  accessories | 6 x D-1235 11014D123 |



RECHTS / RIGHT / DROITE

PK3 001 02BP

HST 1120 CV0 00037





Mollblech -Streichblech

Mouldboard / Versoir

LINKS / LEFT / GAUCHE

PK4 002 02BP

HST 1170 CV0 00040

| | |
|---|--|
|  Unit weight | 13,86 |
|  color |  rot |
|  piece unit | 50 Pal |
|  accessories | 6 x D-1235 11014D123 |



RECHTS / RIGHT / DROITE

PK4 001 02BP

HST 1160 CV0 00039





Schare

Share / Soc

RECHTS / RIGHT / DROITE

CV0 000 61

KMF257 C RE

| | |
|---|---|
|  Unit weight | 3,30 |
|  color |  rot |
|  piece unit | 150 Pal |
|  accessories | 2 x D-1235 11014D123 |







Schare

Share / Soc

LINKS / LEFT / GAUCHE

CV0 000 90

SS 1090

| | |
|---|--|
|  Unit weight | 4,50 |
|  color |  rot |
|  piece unit | 150 Pal |
|  accessories | 2 x D-1235 11014D123 |



RECHTS / RIGHT / DROITE

CV0 000 89

SS 1080

Teile passend zu
parts interchangeable
Pièces adaptables pour

DIN-Teile

Schare

Share / Soc

LINKS / LEFT / GAUCHE





CV0 000 12

SS 1090-3

RECHTS / RIGHT / DROITE

CV0 000 11

SS 1080-3

| | |
|---|--|
|  Unit weight | 4,45 |
|  color | ■ rot |
|  piece unit | 150 Pal |
|  accessories | 3 x D-1235 11014D123 |



Schare

Share / Soc

LINKS / LEFT / GAUCHE





CV0 000 14

SS 1110

RECHTS / RIGHT / DROITE

CV0 000 13

SS 1100

| | |
|---|--|
|  Unit weight | 4,60 |
|  color | ■ rot |
|  piece unit | 150 Pal |
|  accessories | 3 x D-1235 11014D123 |



Schare

Share / Soc

LINKS / LEFT / GAUCHE





CV0 000 16

SS 1150, SS1110

RECHTS / RIGHT / DROITE

CV0 000 15

SS 1140

| | |
|---|--|
|  Unit weight | 4,90 |
|  color | ■ rot |
|  piece unit | 150 Pal |
|  accessories | 3 x D-1235 11014D123 |







Verschleißstück - Streichblech - Vorderteil

Wearing part - Moulboard - Front part / Etrave

RECHTS / RIGHT / DROITE

CV0 000 41

VST 1060

| | |
|---|--|
|  Unit weight | 1,30 |
|  color | ■ rot |
|  piece unit | 500 Pal |
|  accessories | 2 x D-1235 11014D123 |



Verschleißstück - Streichblech - Vorderteil

Wearing part - Moulboard - Front part / Etrave

LINKS / LEFT / GAUCHE





PK3 002 03BP

VST1130 CV000046

RECHTS / RIGHT / DROITE

PK3 001 03BP

VST1120 CV000045

| | |
|---|--|
|  Unit weight | 1,60 |
|  color | ■ rot |
|  piece unit | 500 Pal |
|  accessories | 2 x D-1235 11014D123 |



Verschleißstück - Streichblech - Vorderteil

Wearing part - Moulboard - Front part / Etrave

LINKS / LEFT / GAUCHE





PK4 002 03BP

VST1170 CV000048

RECHTS / RIGHT / DROITE

PK4 001 03BP

VST1160 CV000047

| | |
|---|--|
|  Unit weight | 1,67 |
|  color | ■ rot |
|  piece unit | 500 Pal |
|  accessories | 2 x D-1235 11014D123 |



Teile passend zu
parts interchangeable
Pièces adaptables pour

Duro

Anlage

Landside / Contre-Sep

LINKS / LEFT / GAUCHE





P89 035 01P

P8903501

RECHTS / RIGHT / DROITE

P89 034 01P

P8903401

| | |
|---|---|
|  Unit weight | 3,35 |
|  color |  rot |
|  piece unit | 300 Pal |
|  accessories | 6 x G-1240, 523732V 1 x I-1675 PK800010 M. |



Anlage

Landside / Contre-Sep

LINKS / LEFT / GAUCHE





P89 037 01P

P8903701

RECHTS / RIGHT / DROITE

P89 036 01P

P8903601

| | |
|---|--|
|  Unit weight | 5,40 |
|  color |  rot |
|  piece unit | 200 Pal |
|  accessories | 6 x G-1240, 523732V 1 x I-1675 PK800010 M. |



Anlage

Landside / Contre-Sep

LINKS / LEFT / GAUCHE





CD0 009 05

R6469

RECHTS / RIGHT / DROITE

CD0 009 04

R6468

| | |
|---|---|
|  Unit weight | 3,07 |
|  color |  rot |
|  piece unit | 300 Pal |
|  accessories | |







Düngereinlegeschar

Skim Point / Soc de Rasette

RECHTS / RIGHT / DROITE

CD0 009 06

5370

| | |
|---|--|
|  Unit weight | 1,45 |
|  color |  rot |
|  piece unit | 500 Pal |
|  accessories | |

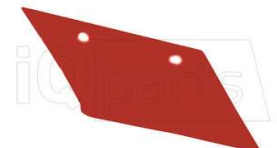

Düngereinlegeschar

Skim Point / Soc de Rasette

LINKS / LEFT / GAUCHE





CD0 009 03

6603

RECHTS / RIGHT / DROITE

CD0 009 02

6604

| | |
|---|---|
|  Unit weight | 1,20 |
|  color |  rot |
|  piece unit | 500 Pal |
|  accessories | |



Meissel - Wechselspitze

Reversible Point / Pointe Reversible

LINKS / LEFT / GAUCHE





CD0 000 06

6431

RECHTS / RIGHT / DROITE

CD0 000 05

6432

| | |
|---|--|
|  Unit weight | 1,45 |
|  color |  rot |
|  piece unit | 500 Pal |
|  accessories | |







Mollblech - Streichblech

Mouldboard / Versoir

CD0 002 01

CD0 002 01

| | |
|---|---|
|  Unit weight | 11,00 |
|  color |  rot |
|  piece unit | 50 Pal |
|  accessories | |



Schare - Wechselspitzenschare

Share for rev. Point / Soc pour pointe reversilbe

LINKS / LEFT / GAUCHE





CD0 009 00

6429

RECHTS / RIGHT / DROITE

CD0 008 00

6430

| | |
|---|--|
|  Unit weight | 6,30 |
|  color |  rot |
|  piece unit | 75 Pal |
|  accessories | |



Teile passend zu
parts interchangeable
Pièces adaptables pour

Duro





Schare - Wechselspitzschare

Share for rev. Point / Soc pour pointe reversilbe

RECHTS / RIGHT / DROITE

P90 034 03

P90 03403 U1300 M re

| | |
|---|---|
|  Unit weight | 5,25 |
|  color |  rot |
|  piece unit | 200 Pal |
|  accessories | 3 x D-1235 11014D123 |



Teile passend zu
parts interchangeable
Pièces adaptables pour

Eberhardt





Anlage

Landside / Contre-Sep

RECHTS / RIGHT / DROITE

CE1 000 88

110 210

| | |
|---|---|
|  Unit weight | 3,00 |
|  color |  rot |
|  piece unit | 350 Pal |
|  accessories | 3 x D-1240, 546200V |







Anlage

Landside / Contre-Sep

CE1 001 02

301 162

| | |
|---|--|
|  Unit weight | 4,00 |
|  color |  rot |
|  piece unit | 250 Pal |
|  accessories | 3 x D-1235 11014D123 |







Düngereinlegeblech

Skimmer Board / Versoirs de Rasette

LINKS / LEFT / GAUCHE

CE1 001 10

8050 220030

| | |
|---|---|
|  Unit weight | 3,00 |
|  color |  rot |
|  piece unit | 300 Pal |
|  accessories | 2 x D-1030, 523742V |



RECHTS / RIGHT / DROITE

CE1 001 09

8050 220020





Düngereinlegeschar

Skim Point / Soc de Rasette

LINKS / LEFT / GAUCHE

CE1 000 87

22 025

| | |
|---|--|
|  Unit weight | 1,05 |
|  color |  rot |
|  piece unit | 900 Pal |
|  accessories | 2 x D-1030, 523742V |

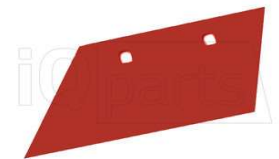

RECHTS / RIGHT / DROITE

CE1 000 86

22 024





Düngereinlegeschar

Skim Point / Soc de Rasette

LINKS / LEFT / GAUCHE

CE1 000 93

22603 303641

| | |
|---|---|
|  Unit weight | 0,95 |
|  color |  rot |
|  piece unit | 600 Pal |
|  accessories | 2 x D-1030, 523742V |



RECHTS / RIGHT / DROITE

CE1 000 92

22602 303642





Schare

Share / Soc

RECHTS / RIGHT / DROITE

CE1 000 60

54 550

| | |
|---|--|
|  Unit weight | 5,05 |
|  color |  rot |
|  piece unit | 150 Pal |
|  accessories | 3 x D-1235 11014D123 |







Schare

Share / Soc

LINKS / LEFT / GAUCHE

CE1 000 69

55 585

| | |
|---|---|
|  Unit weight | 4,95 |
|  color |  rot |
|  piece unit | 150 Pal |
|  accessories | 3 x A-1640, 548350V |



RECHTS / RIGHT / DROITE

CE1 000 68

55 584





Scharspitze

Share point / Nez de Soc

LINKS / LEFT / GAUCHE

CE1 000 95

302 491

| | |
|---|--|
|  Unit weight | 2,25 |
|  color |  rot |
|  piece unit | 500 Pal |
|  accessories | 2 x A-1640, 548350V |



RECHTS / RIGHT / DROITE

CE1 000 94

302 490

Teile passend zu
parts interchangeable
Pièces adaptables pour

Eberhardt





Streifen

Strips for slated body / Lame pour clair Voie

RECHTS / RIGHT / DROITE

CE1 001 11

304 588

| | |
|---|---|
|  Unit weight | 4,40 |
|  color |  rot |
|  piece unit | 200 Pal |
|  accessories | 2 x D-1235 11014D123 |







Verschleißstück - Streichblech - Vorderteil

Wearing part - Moulboard - Front part / Etrave

LINKS / LEFT / GAUCHE

CE1 000 85

40 003

| | |
|---|--|
|  Unit weight | 2,00 |
|  color |  rot |
|  piece unit | 500 Pal |
|  accessories | 2 x D-1235 11014D123 |



RECHTS / RIGHT / DROITE

CE1 000 84

40 002

Teile passend zu
parts interchangeable
Pièces adaptables pour

Fortschritt





Mollblech - Streichblech

Mouldboard / Versoir

RECHTS / RIGHT / DROITE

CV0 060 04

3010 10087

| | |
|---|---|
|  Unit weight | 15,40 |
|  color |  schwarz |
|  piece unit | 50 Pal |
|  accessories | 6 x B-1235 - 3015785, 5 |





Schare

Share / Soc

LINKS / LEFT / GAUCHE

CV0 060 02A

30 ZKL

| | |
|---|--|
|  Unit weight | 5,80 |
|  color |  schwarz |
|  piece unit | 150 Pal |
|  accessories | 3 x B-1235 - 3015785, 5 |

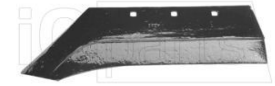

RECHTS / RIGHT / DROITE

CV0 060 02

30ZK 301000045





Schare - Wechselspitzenchare

Share for rev. Point / Soc pour pointe reversilbe

RECHTS / RIGHT / DROITE

CV0 060 09

30 ZM

| | |
|---|---|
|  Unit weight | 5,40 |
|  color |  schwarz |
|  piece unit | 150 Pal |
|  accessories | 3 x B-1235 - 3015785, 5 |

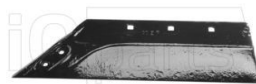





Verschleißstück - Streichblech - Vorderteil

Wearing part - Moulboard - Front part / Etrave

RECHTS / RIGHT / DROITE

CV0 060 05

3010 10088

| | |
|---|--|
|  Unit weight | 3,25 |
|  color |  schwarz |
|  piece unit | 350 Pal |
|  accessories | 3 x B-1235 - 3015785, 5 |



Teile passend zu
parts interchangeable
Pièces adaptables pour

FROST

Meissel - Wechselspitze
Reversible Point / Pointe Reversible

LINKS / LEFT / GAUCHE

CV2 000 08

50613

RECHTS / RIGHT / DROITE

CV2 000 07

50612

| | | |
|--|-------------|---------------------|
| | Unit weight | 2,05 |
| | color | schwarz |
| | piece unit | |
| | accessories | 2 x G-1234, 523998V |



Teile passend zu
parts interchangeable
Pièces adaptables pour





GASPARDO

Anlage

Landside / Contre-Sep

CM3 000 15

A5210 0012

| | |
|---|--|
|  Unit weight | 3,88 |
|  color | ■ rot |
|  piece unit | 200 Pal |
|  accessories | 2 x B-1235 - 3015785, 5 |







Anlage

Landside / Contre-Sep

CM3 000 12

A5210 0032

| | |
|---|--|
|  Unit weight | 5,31 |
|  color | ■ rot |
|  piece unit | 150 Pal |
|  accessories | 2 x B-1235 - 3015785, 5 |







Anlage

Landside / Contre-Sep

CM3 000 16

A5210 0440

| | |
|---|--|
|  Unit weight | 3,88 |
|  color | ■ rot |
|  piece unit | 250 Pal |
|  accessories | 2 x B-1235 - 3015785, 5 |







Anlagensech

Sword Landside / Ailerons Coutre

LINKS / LEFT / GAUCHE

CM3 000 18

A5090 0041

| | |
|---|--|
|  Unit weight | 2,77 |
|  color | ■ rot |
|  piece unit | 300 Pal |
|  accessories | 2 x B-1235 - 3015785, 5 |

RECHTS / RIGHT / DROITE

CM3 000 17

A5090 0051

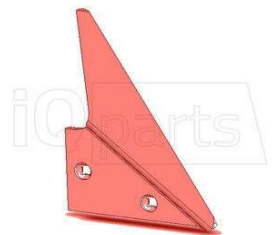





Anlagenspitze

Landside top / Pointe de Contre Sep

LINKS / LEFT / GAUCHE

CM3 000 14

A5034 1930

| | |
|---|--|
|  Unit weight | 0,00 |
|  color | ■ rot |
|  piece unit | 500 Pal |
|  accessories | 2 x B-1235 - 3015785, 5 |

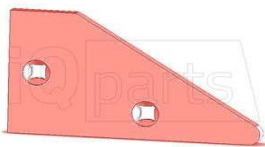

RECHTS / RIGHT / DROITE

CM3 000 13





A5034 1940

Gleitplatte

Sliding Plate / Talon

CM3 000 19

A5210 0510

| | |
|---|--|
|  Unit weight | 2,85 |
|  color | ■ rot |
|  piece unit | 300 Pal |
|  accessories | 2 x B-1235 - 3015785, 5 |

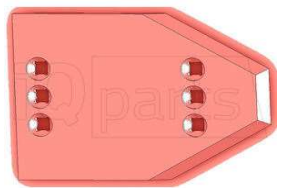





Meissel - Wechselspitze

Reversible Point / Pointe Reversible

LINKS / LEFT / GAUCHE

CM3 000 11

A5200 0020

| | |
|---|--|
|  Unit weight | 1,57 |
|  color | ■ rot |
|  piece unit | 500 Pal |
|  accessories | 2 x G-1240, 523732V |

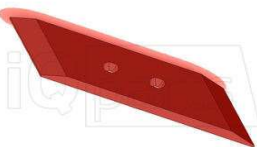

RECHTS / RIGHT / DROITE

CM3 000 10

A5200 0010

Teile passend zu
parts interchangeable
Pièces adaptables pour

Gassner





Anlage

Landside / Contre-Sep

RECHTS / RIGHT / DROITE

CV0 000 63

K 1063

| | |
|---|---|
|  Unit weight | 2,65 |
|  color |  rot |
|  piece unit | 400 Pal |
|  accessories | 2 x D-1235 11014D123 1 x A-1640, 548350V |







Anlage

Landside / Contre-Sep

LINKS / LEFT / GAUCHE

CV0 000 68

K 1093

| | |
|---|--|
|  Unit weight | 3,60 |
|  color |  rot |
|  piece unit | 250 Pal |
|  accessories | 2 x D-1235 11014D123 1 x A-1640, 548350V |



RECHTS / RIGHT / DROITE

CV0 000 67

K 1083





Düngereinlegeschar

Skim Point / Soc de Rasette

LINKS / LEFT / GAUCHE

CV0 000 08

FR3

| | |
|---|---|
|  Unit weight | 0,50 |
|  color |  rot |
|  piece unit | 1 000 Pal |
|  accessories | 1 x B-1035 608D1035N |



RECHTS / RIGHT / DROITE

CV0 000 07

FR3





Mollblech -Streichblech

Mouldboard / Versoir

LINKS / LEFT / GAUCHE

PK2 002 02B

HST 1090 CV000036

| | |
|---|--|
|  Unit weight | 9,50 |
|  color |  rot |
|  piece unit | 100 Pal |
|  accessories | 6 x D-1235 11014D123 |



RECHTS / RIGHT / DROITE

PK2 001 02B

HST 1080 CV000035





Mollblech -Streichblech

Mouldboard / Versoir

LINKS / LEFT / GAUCHE

PK3 002 02BP

HST1130 CV000038

| | |
|---|---|
|  Unit weight | 11,50 |
|  color |  rot |
|  piece unit | 50 Pal |
|  accessories | 6 x D-1235 11014D123 |



RECHTS / RIGHT / DROITE

PK3 001 02BP

HST 1120 CV0 00037





Mollblech -Streichblech

Mouldboard / Versoir

LINKS / LEFT / GAUCHE

PK4 002 02BP

HST1170 CV000040

| | |
|---|--|
|  Unit weight | 13,86 |
|  color |  rot |
|  piece unit | 50 Pal |
|  accessories | 6 x D-1235 11014D123 |

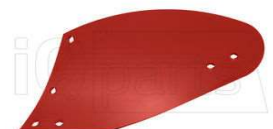

RECHTS / RIGHT / DROITE

PK4 001 02BP

HST 1160 CV0 00039





Schare

Share / Soc

LINKS / LEFT / GAUCHE

CV0 000 90

SS 1090

| | |
|---|---|
|  Unit weight | 4,50 |
|  color |  rot |
|  piece unit | 150 Pal |
|  accessories | 2 x D-1235 11014D123 |



RECHTS / RIGHT / DROITE

CV0 000 89

SS 1080





Schare

Share / Soc

LINKS / LEFT / GAUCHE

CV0 000 12

SS 1090-3

| | |
|---|--|
|  Unit weight | 4,45 |
|  color |  rot |
|  piece unit | 150 Pal |
|  accessories | 3 x D-1235 11014D123 |



RECHTS / RIGHT / DROITE

CV0 000 11

SS 1080-3

Teile passend zu
parts interchangeable
Pièces adaptables pour

Gassner

Schare

Share / Soc

LINKS / LEFT / GAUCHE





CV0 000 14

SS 1110

RECHTS / RIGHT / DROITE

CV0 000 13

SS 1100

| | |
|---|---|
|  Unit weight | 4,60 |
|  color |  rot |
|  piece unit | 150 Pal |
|  accessories | 3 x D-1235 11014D123 |



Schare

Share / Soc

LINKS / LEFT / GAUCHE





CV0 000 16

SS 1150, SS1110

RECHTS / RIGHT / DROITE

CV0 000 15

SS 1140

| | |
|---|--|
|  Unit weight | 4,90 |
|  color |  rot |
|  piece unit | 150 Pal |
|  accessories | 3 x D-1235 11014D123 |







Verschleißstück - Streichblech - Vorderteil

Wearing part - Moulboard - Front part / Etrave

RECHTS / RIGHT / DROITE

CV0 000 41

VST 1060

| | |
|---|---|
|  Unit weight | 1,30 |
|  color |  rot |
|  piece unit | 500 Pal |
|  accessories | 2 x D-1235 11014D123 |



Verschleißstück - Streichblech - Vorderteil

Wearing part - Moulboard - Front part / Etrave

LINKS / LEFT / GAUCHE





PK4 002 03BP

VST1170 CV000048

RECHTS / RIGHT / DROITE

PK4 001 03BP

VST1160 CV000047

| | |
|---|--|
|  Unit weight | 1,67 |
|  color |  rot |
|  piece unit | 500 Pal |
|  accessories | 2 x D-1235 11014D123 |



Teile passend zu
parts interchangeable
Pièces adaptables pour

GOIZIN

Anlage

Landside / Contre-Sep

LINKS / LEFT / GAUCHE





CG2 000 12

010 584G

RECHTS / RIGHT / DROITE

CG2 000 11

010 534D

| | |
|---|-----------|
|  Unit weight | 3,20 |
|  color | ■ schwarz |
|  piece unit | 300 Pal |
|  accessories | |



Düngereinlegeschar

Skim Point / Soc de Rasette

LINKS / LEFT / GAUCHE





CG2 000 14

010 782G

RECHTS / RIGHT / DROITE

CG2 000 13

010 732D

| | |
|---|-----------|
|  Unit weight | 1,10 |
|  color | ■ schwarz |
|  piece unit | 500 Pal |
|  accessories | |







Gleitplatte

Sliding Plate / Talon

CG2 000 17

010 327 D/G

| | |
|---|-----------|
|  Unit weight | 2,50 |
|  color | ■ schwarz |
|  piece unit | 300 Pal |
|  accessories | |

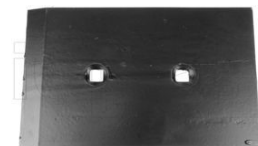

Meissel - Wechselspitze

Reversible Point / Pointe Reversible

LINKS / LEFT / GAUCHE





CG2 000 10

010 154G

RECHTS / RIGHT / DROITE

CG2 000 09

010 104D

| | |
|---|-----------|
|  Unit weight | 1,80 |
|  color | ■ schwarz |
|  piece unit | |
|  accessories | |



Meissel - Wechselspitze

Reversible Point / Pointe Reversible

LINKS / LEFT / GAUCHE





CG1 000 28

010154G

RECHTS / RIGHT / DROITE

CG1 000 27

010104D

| | |
|---|-----------|
|  Unit weight | 2,05 |
|  color | ■ schwarz |
|  piece unit | 500 Pal |
|  accessories | |



Schare - Wechselspitzenschare

Share for rev. Point / Soc pour pointe reversilbe

LINKS / LEFT / GAUCHE





CG2 000 04

010 450G 14"

RECHTS / RIGHT / DROITE

CG2 000 03

010 400D 14"

| | |
|---|-----------|
|  Unit weight | 5,40 |
|  color | ■ schwarz |
|  piece unit | 75 Pal |
|  accessories | |



Schare - Wechselspitzenschare

Share for rev. Point / Soc pour pointe reversilbe

LINKS / LEFT / GAUCHE





CG2 000 06

010 550G 15"

RECHTS / RIGHT / DROITE

CG2 000 05

010 500D 15"

| | |
|---|-----------|
|  Unit weight | 5,80 |
|  color | ■ schwarz |
|  piece unit | 75 Pal |
|  accessories | |



Schare - Wechselspitzenschare

Share for rev. Point / Soc pour pointe reversilbe

LINKS / LEFT / GAUCHE





CG2 000 08

010 650G 16"

RECHTS / RIGHT / DROITE

CG2 000 07

010 600D 16"

| | |
|---|-----------|
|  Unit weight | 6,20 |
|  color | ■ schwarz |
|  piece unit | 75 Pal |
|  accessories | |



Teile passend zu
parts interchangeable
Pièces adaptables pour

Gregoire Besson

Anlage
Landside / Contre-Sep

CG1 001 19
1119842 REVERSIBLE D9

| | |
|-------------|-----------|
| Unit weight | 2,68 |
| color | ■ schwarz |
| piece | 300 |
| unit | Pal |
| accessories | |

Anlage
Landside / Contre-Sep

LINKS / LEFT / GAUCHE
CG1 001 20
1119850 L

RECHTS / RIGHT / DROITE
CG1 001 21
1119851 R

| | |
|-------------|-----------|
| Unit weight | 2,02 |
| color | ■ schwarz |
| piece | 400 |
| unit | Pal |
| accessories | |

Anlage
Landside / Contre-Sep

CG1 000 51
172321 80x10

| | |
|-------------|-----------|
| Unit weight | 2,60 |
| color | ■ schwarz |
| piece | 250 |
| unit | Pal |
| accessories | |



Anlage
Landside / Contre-Sep

CG1 000 51
172338 80x10

| | |
|-------------|-----------|
| Unit weight | 2,60 |
| color | ■ schwarz |
| piece | 250 |
| unit | Pal |
| accessories | |



Anlage
Landside / Contre-Sep

CG1 000 53
172380 120x12 Center hole Nr.3

| | |
|-------------|-----------|
| Unit weight | 5,25 |
| color | ■ schwarz |
| piece | 200 |
| unit | Pal |
| accessories | |



Anlage
Landside / Contre-Sep

CG1 000 53N
172380 M12-DIN608

| | |
|-------------|-----------------------|
| Unit weight | 5,25 |
| color | ■ schwarz |
| piece | 200 |
| unit | Pal |
| accessories | 2 x B-1240 2700 2607, |



Anlage
Landside / Contre-Sep

CG1 001 16
172380 OVAL HOLE REVERSIBLE

| | |
|-------------|-----------|
| Unit weight | 5,20 |
| color | ■ schwarz |
| piece | 150 |
| unit | Pal |
| accessories | |



Anlage
Landside / Contre-Sep

LINKS / LEFT / GAUCHE
CG1 000 55
173333

RECHTS / RIGHT / DROITE
CG1 000 54
173334





| | |
|-------------|-----------|
| Unit weight | 2,50 |
| color | ■ schwarz |
| piece | 200 |
| unit | Pal |
| accessories | |



Teile passend zu
parts interchangeable
Pièces adaptables pour





Gregoire Besson

| | |
|--|-------------------------|
| Anlage Landside / Contre-Sep | |
| LINKS / LEFT / GAUCHE | RECHTS / RIGHT / DROITE |
| CG1 000 55 | CG1 000 54 |
| 173337 | 173338 |

| | |
|---|---|
|  Unit weight | 2,50 |
|  color |  schwarz |
|  piece unit | 200 Pal |
|  accessories | |







| | |
|--|--|
| Anlage Landside / Contre-Sep | |
| CG1 000 52N | |
| 173388 M12-DIN608 | |

| | |
|---|--|
|  Unit weight | 4,90 |
|  color |  schwarz |
|  piece unit | 200 Pal |
|  accessories | 2 x B-1240 2700 2607, |







| | |
|--|--|
| Anlage Landside / Contre-Sep | |
| CG1 000 52 | |
| 173388 B2 Nr.3 | |

| | |
|---|---|
|  Unit weight | 4,90 |
|  color |  schwarz |
|  piece unit | 200 Pal |
|  accessories | |







| | |
|--|--|
| Anlage Landside / Contre-Sep | |
| CG1 001 15 | |
| 173395 REVERSIBLE No.4 | |

| | |
|---|--|
|  Unit weight | 9,80 |
|  color |  schwarz |
|  piece unit | 100 Pal |
|  accessories | |







| | |
|--|--|
| Anlage Landside / Contre-Sep | |
| CG1 000 94 | |
| 177319 | |

| | |
|---|---|
|  Unit weight | 5,15 |
|  color |  schwarz |
|  piece unit | 200 Pal |
|  accessories | |







| | |
|--|-------------------------|
| Düngereinlegeblech Skimmer Board / Versoirs de Rasette | |
| LINKS / LEFT / GAUCHE | RECHTS / RIGHT / DROITE |
| CG1 000 08 | CG1 000 07 |
| 19171 | 19172 |

| | |
|---|--|
|  Unit weight | 1,60 |
|  color |  schwarz |
|  piece unit | 300 Pal |
|  accessories | 2 x C-1235, 523997V |







| | |
|--|-------------------------|
| Düngereinlegeblech Skimmer Board / Versoirs de Rasette | |
| LINKS / LEFT / GAUCHE | RECHTS / RIGHT / DROITE |
| CG1 000 18 | CG1 000 17 |
| 19187 | 19188 |

| | |
|---|---|
|  Unit weight | 2,75 |
|  color |  schwarz |
|  piece unit | 300 Pal |
|  accessories | |



| | |
|--|-------------------------|
| Düngereinlegeschar Skim Point / Soc de Rasette | |
| LINKS / LEFT / GAUCHE | RECHTS / RIGHT / DROITE |
| CG1 000 04D | CG1 000 03D |
| 19113 Diamant | 19114 Diamant |

| | |
|---|--|
|  Unit weight | 1,90 |
|  color |  schwarz |
|  piece unit | 500 Pal |
|  accessories | 2 x C-1235, 523997V |



Teile passend zu
parts interchangeable
Pièces adaptables pour

Gregoire Besson

Düngereinlegeschar

Skim Point / Soc de Rasette

LINKS / LEFT / GAUCHE





CG1 000 04

19 113 12MM

RECHTS / RIGHT / DROITE

CG1 000 03

19 114 - 12mm

| | |
|---|---|
|  Unit weight | 1,55 |
|  color |  schwarz |
|  piece unit | 500 Pal |
|  accessories | 2 x C-1235, 523997V |



Düngereinlegeschar

Skim Point / Soc de Rasette

LINKS / LEFT / GAUCHE





CG1 000 06

19125 12MM

RECHTS / RIGHT / DROITE

CG1 000 05

19 126 12MM

| | |
|---|--|
|  Unit weight | 2,11 |
|  color |  schwarz |
|  piece unit | 500 Pal |
|  accessories | 2 x C-1235, 523997V |







Gleitplatte

Sliding Plate / Talon

CG1 000 72

177349 120x12mm

| | |
|---|---|
|  Unit weight | 3,00 |
|  color |  schwarz |
|  piece unit | 300 Pal |
|  accessories | |







Gleitplatte

Sliding Plate / Talon

CG1 000 72V

177349 120x15MM

| | |
|---|--|
|  Unit weight | 3,66 |
|  color |  schwarz |
|  piece unit | 300 Pal |
|  accessories | |







Grindel

Leg / Âge

CG1 000 31

19179

| | |
|---|---|
|  Unit weight | 1,80 |
|  color |  schwarz |
|  piece unit | 500 Pal |
|  accessories | |



Meissel - Wechselspitze





Reversible Point / Pointe Reversible

CG1 000 29

171207 30x30

CG1 000 30

172330 35x35

| | |
|---|--|
|  Unit weight | 5,25 |
|  color |  sandgestrahlt |
|  piece unit | 200 Pal |
|  accessories | |



Meissel - Wechselspitze

Reversible Point / Pointe Reversible

LINKS / LEFT / GAUCHE





CG1 000 28

173331 3-hole

RECHTS / RIGHT / DROITE

CG1 000 27

010104D

| | |
|---|---|
|  Unit weight | 2,05 |
|  color |  schwarz |
|  piece unit | 500 Pal |
|  accessories | |



Meissel - Wechselspitze

Reversible Point / Pointe Reversible

LINKS / LEFT / GAUCHE





CG1 001 01

177327

RECHTS / RIGHT / DROITE

CG1 001 00

177328

| | |
|---|--|
|  Unit weight | 2,05 |
|  color |  schwarz |
|  piece unit | 500 Pal |
|  accessories | |

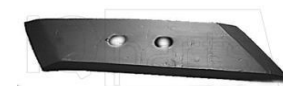

Teile passend zu
parts interchangeable
Pièces adaptables pour

Gregoire Besson

Mollblech -Streichblech
Mouldboard / Versoir

| LINKS / LEFT / GAUCHE | RECHTS / RIGHT / DROITE |
|-----------------------------|-----------------------------|
| CG1 000 91 173427 | CG1 000 90 173428 |

| | |
|-------------|---------------------|
| Unit weight | 19,60 |
| color | schwarz |
| piece unit | 50 Pal |
| accessories | 9 x C-1235, 523997V |



Mollblech -Streichblech
Mouldboard / Versoir

| LINKS / LEFT / GAUCHE | RECHTS / RIGHT / DROITE |
|-----------------------------|-----------------------------|
| CG1 000 37 173435 | CG1 000 38 173436 |

| | |
|-------------|---------------------|
| Unit weight | 15,30 |
| color | schwarz |
| piece unit | 50 Pal |
| accessories | 7 x C-1235, 523997V |



Mollblech -Streichblech
Mouldboard / Versoir

| LINKS / LEFT / GAUCHE | RECHTS / RIGHT / DROITE |
|-----------------------------|-----------------------------|
| CG1 000 91 173459 | CG1 000 90 173460 |

| | |
|-------------|---------------------|
| Unit weight | 19,60 |
| color | schwarz |
| piece unit | 50 Pal |
| accessories | 9 x C-1235, 523997V |



Mollblech -Streichblech
Mouldboard / Versoir

| LINKS / LEFT / GAUCHE | RECHTS / RIGHT / DROITE |
|-----------------------------|-----------------------------|
| CG1 000 37 173483 | CG1 000 38 173484 |

| | |
|-------------|---------------------|
| Unit weight | 15,30 |
| color | schwarz |
| piece unit | 50 Pal |
| accessories | 7 x C-1235, 523997V |



Mollblech -Streichblech
Mouldboard / Versoir

| LINKS / LEFT / GAUCHE | RECHTS / RIGHT / DROITE |
|-----------------------------|-----------------------------|
| CG1 001 05 177425 | CG1 001 04 177426 |

| | |
|-------------|----------------------|
| Unit weight | 19,30 |
| color | schwarz |
| piece unit | 50 Pal |
| accessories | 11 x C-1235, 523997V |



Mollblech -Streichblech
Mouldboard / Versoir

| LINKS / LEFT / GAUCHE | RECHTS / RIGHT / DROITE |
|-----------------------------|-----------------------------|
| CG1 001 05 177435 | CG1 001 04 177436 |

| | |
|-------------|----------------------|
| Unit weight | 19,30 |
| color | schwarz |
| piece unit | 50 Pal |
| accessories | 11 x C-1235, 523997V |



Mollblech -Streichblech
Mouldboard / Versoir

| LINKS / LEFT / GAUCHE | RECHTS / RIGHT / DROITE |
|-----------------------------|-----------------------------|
| CG1 001 03 177439 | CG1 001 02 177440 |

| | |
|-------------|----------------------|
| Unit weight | 19,40 |
| color | schwarz |
| piece unit | 50 Pal |
| accessories | 11 x D-1240, 546200V |



Mollblech -Streichblech
Mouldboard / Versoir

| LINKS / LEFT / GAUCHE | RECHTS / RIGHT / DROITE |
|-----------------------------|-----------------------------|
| CG1 001 03 177441 | CG1 001 02 177442 |

| | |
|-------------|----------------------|
| Unit weight | 19,40 |
| color | schwarz |
| piece unit | 50 Pal |
| accessories | 11 x D-1240, 546200V |



Teile passend zu
parts interchangeable
Pièces adaptables pour

Gregoire Besson

| Schare Share / Soc | | Schare Share / Soc | |
|--|--|--|--|
| LINKS / LEFT / GAUCHE | RECHTS / RIGHT / DROITE | LINKS / LEFT / GAUCHE | RECHTS / RIGHT / DROITE |
| CG1 000 23 | CG1 000 24 | CG1 000 23 | CG1 000 24 |
| 172401 150x11 14" | 172 402 150x11 14" | 172417 150x11 14" | 172418 150x11 14" |
| Unit weight 4,50 | Unit weight 4,50 | Unit weight 4,50 | Unit weight 4,50 |
| color schwarz | color schwarz | color schwarz | color schwarz |
| piece 150 | piece 150 | piece 150 | piece 150 |
| unit Pal | unit Pal | unit Pal | unit Pal |
| accessories | accessories | accessories | accessories |



| Schare Share / Soc | | Schare Share / Soc | |
|--|--|--|--|
| LINKS / LEFT / GAUCHE | RECHTS / RIGHT / DROITE | LINKS / LEFT / GAUCHE | RECHTS / RIGHT / DROITE |
| CG1 000 12 | CG1 000 11 | CG1 000 12 | CG1 000 11 |
| 172601 150 x 11MM 16" | 172602 150 x 11 MM 16" | 172613 150 x 11 MM 16" | 172614 150 x 11 MM 16" |
| Unit weight 4,95 | Unit weight 4,95 | Unit weight 4,95 | Unit weight 4,95 |
| color schwarz | color schwarz | color schwarz | color schwarz |
| piece 150 | piece 150 | piece 150 | piece 150 |
| unit Pal | unit Pal | unit Pal | unit Pal |
| accessories | accessories | accessories | accessories |



| Schare - Wechselspitzschare Share for rev. Point / Soc pour pointe reversilbe | | Schare - Wechselspitzschare Share for rev. Point / Soc pour pointe reversilbe | |
|--|--|--|--|
| LINKS / LEFT / GAUCHE | RECHTS / RIGHT / DROITE | LINKS / LEFT / GAUCHE | RECHTS / RIGHT / DROITE |
| CG1 000 20 | CG1 000 19 | CG1 000 22 | CG1 000 21 |
| 173423 B2 14" | 173424 B2 14" | 173613 B2 16" | 173614 B2 16" |
| Unit weight 5,40 | Unit weight 5,40 | Unit weight 5,85 | Unit weight 5,85 |
| color schwarz | color schwarz | color schwarz | color schwarz |
| piece 150 | piece 150 | piece 150 | piece 150 |
| unit Pal | unit Pal | unit Pal | unit Pal |
| accessories | accessories | accessories | accessories |



| Schare - Wechselspitzschare Share for rev. Point / Soc pour pointe reversilbe | | Schare - Wechselspitzschare Share for rev. Point / Soc pour pointe reversilbe | |
|--|--|--|--|
| LINKS / LEFT / GAUCHE | RECHTS / RIGHT / DROITE | LINKS / LEFT / GAUCHE | RECHTS / RIGHT / DROITE |
| CG1 000 22V | CG1 000 21V | CG1 001 18 | CG1 001 17 |
| 173613 V 16" | 173614 V 16" | 173801 18" | 173802 18" |
| Unit weight 6,50 | Unit weight 6,50 | Unit weight 8,80 | Unit weight 8,80 |
| color schwarz | color schwarz | color schwarz | color schwarz |
| piece 150 | piece 150 | piece 100 | piece 100 |
| unit Pal | unit Pal | unit Pal | unit Pal |
| accessories | accessories | accessories | accessories |



Teile passend zu
parts interchangeable
Pièces adaptables pour

Gregoire Besson

Schare - Wechselspitzenschare

Share for rev. Point / Soc pour pointe reversilbe

LINKS / LEFT / GAUCHE

CG1 000 22E

177601





RECHTS / RIGHT / DROITE

CG1 000 21E

177602

16"

16"

| | |
|---|---|
|  Unit weight | 6,72 |
|  color |  schwarz |
|  piece unit | 150 Pal |
|  accessories | |



Schare - Wechselspitzenschare

Share for rev. Point / Soc pour pointe reversilbe

LINKS / LEFT / GAUCHE





CG1 000 87

178123

RECHTS / RIGHT / DROITE

CG1 000 86

178124

| | |
|---|--|
|  Unit weight | 5,05 |
|  color |  schwarz |
|  piece unit | 150 Pal |
|  accessories | |



Schare - Wechselspitzenschare

Share for rev. Point / Soc pour pointe reversilbe

LINKS / LEFT / GAUCHE





CG1 000 89

178125

RECHTS / RIGHT / DROITE

CG1 000 88

178126

| | |
|---|---|
|  Unit weight | 6,45 |
|  color |  schwarz |
|  piece unit | 150 Pal |
|  accessories | |



Scharsech

Coulter Knife / Coutre Incorporé

LINKS / LEFT / GAUCHE





CG1 000 65

173323

RECHTS / RIGHT / DROITE

CG1 000 64

173324

| | |
|---|--|
|  Unit weight | 1,05 |
|  color |  schwarz |
|  piece unit | 500 Pal |
|  accessories | |



Scharspitze

Share point / Nez de Soc

LINKS / LEFT / GAUCHE





CG1 000 28DH

173341 Hardface - Diamant

RECHTS / RIGHT / DROITE

CG1 000 27DH

173342 Hardface - Diamant

| | |
|---|---|
|  Unit weight | 2,15 |
|  color |  schwarz |
|  piece unit | 500 Pal |
|  accessories | |



Scharspitze

Share point / Nez de Soc

LINKS / LEFT / GAUCHE





CG1 000 28D

173341 Diamant

RECHTS / RIGHT / DROITE

CG1 000 27D

173342 Diamant

| | |
|---|--|
|  Unit weight | 2,00 |
|  color |  schwarz |
|  piece unit | 500 Pal |
|  accessories | |



Streichschiene

Tailpress / Rallonge de Versoir

LINKS / LEFT / GAUCHE





CG1 000 75

172311

RECHTS / RIGHT / DROITE

CG1 000 74

172312

| | |
|---|---|
|  Unit weight | 1,77 |
|  color |  schwarz |
|  piece unit | 500 Pal |
|  accessories | |



Streifen

Strips for slated body / Lame pour clair Voie

LINKS / LEFT / GAUCHE





CG1 000 79

178105

RECHTS / RIGHT / DROITE

CG1 000 78

178106

| | |
|---|--|
|  Unit weight | 3,05 |
|  color |  schwarz |
|  piece unit | 300 Pal |
|  accessories | |



Teile passend zu
parts interchangeable
Pièces adaptables pour

Gregoire Besson

Streifen

Strips for slated body / Lame pour clair Voie

| LINKS / LEFT / GAUCHE | RECHTS / RIGHT / DROITE |
|-----------------------|-------------------------|
| CG1 000 81 | CG1 000 80 |
| 178107 | 178108 |

| | |
|-------------|---------|
| Unit weight | 2,72 |
| color | schwarz |
| piece unit | 400 Pal |
| accessories | |



Streifen

Strips for slated body / Lame pour clair Voie

| LINKS / LEFT / GAUCHE | RECHTS / RIGHT / DROITE |
|-----------------------|-------------------------|
| CG1 000 83 | CG1 000 82 |
| 178109 | 178110 |

| | |
|-------------|---------|
| Unit weight | 3,60 |
| color | schwarz |
| piece unit | 400 Pal |
| accessories | |



Streifen

Strips for slated body / Lame pour clair Voie

| LINKS / LEFT / GAUCHE | RECHTS / RIGHT / DROITE |
|-----------------------|-------------------------|
| CG1 000 85 | CG1 000 84 |
| 178111 | 178112 |

| | |
|-------------|---------|
| Unit weight | 6,20 |
| color | schwarz |
| piece unit | 150 Pal |
| accessories | |



Verschleißstück - Streichblech - Vorderteil

Wearing part - Moulboard - Front part / Etrave

| LINKS / LEFT / GAUCHE | RECHTS / RIGHT / DROITE |
|-----------------------|-------------------------|
| CG1 000 44 | CG1 000 43 |
| 173321 | 173322 |

| | |
|-------------|---------------------|
| Unit weight | 2,40 |
| color | schwarz |
| piece unit | 400 Pal |
| accessories | 2 x C-1235, 523997V |



Verschleißstück - Streichblech - Vorderteil

Wearing part - Moulboard - Front part / Etrave

| LINKS / LEFT / GAUCHE | RECHTS / RIGHT / DROITE |
|-----------------------|-------------------------|
| CG1 000 46 | CG1 000 45 |
| 173325 | 173326 |

| | |
|-------------|---------------------|
| Unit weight | 2,08 |
| color | schwarz |
| piece unit | 400 Pal |
| accessories | 2 x C-1235, 523997V |

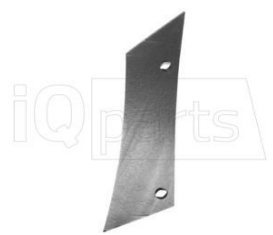

Verschleißstück - Streichblech - Vorderteil

Wearing part - Moulboard - Front part / Etrave

| LINKS / LEFT / GAUCHE | RECHTS / RIGHT / DROITE |
|-----------------------|-------------------------|
| CG1 000 46 | CG1 000 45 |
| 173345 | 173346 |

| | |
|-------------|---------------------|
| Unit weight | 2,08 |
| color | schwarz |
| piece unit | 400 Pal |
| accessories | 2 x C-1235, 523997V |



Verschleißstück - Streichblech - Vorderteil

Wearing part - Moulboard - Front part / Etrave

| LINKS / LEFT / GAUCHE | RECHTS / RIGHT / DROITE |
|-----------------------|-------------------------|
| CG1 000 93 | CG1 000 92 |
| 173461 | 173462 |

| | |
|-------------|---------------------|
| Unit weight | 1,85 |
| color | schwarz |
| piece unit | 400 Pal |
| accessories | 2 x C-1235, 523997V |



Verschleißstück - Streichblech - Vorderteil

Wearing part - Moulboard - Front part / Etrave

| LINKS / LEFT / GAUCHE | RECHTS / RIGHT / DROITE |
|-----------------------|-------------------------|
| CG1 000 47 | CG1 000 48 |
| 173475 | 173476 |

| | |
|-------------|---------------------|
| Unit weight | 2,10 |
| color | schwarz |
| piece unit | 400 Pal |
| accessories | 2 x C-1235, 523997V |



Teile passend zu
parts interchangeable
Pièces adaptables pour

Gregoire Besson

Verschleißstück - Streichblech - Vorderteil
Wearing part - Moulboard - Front part / Etrave

LINKS / LEFT / GAUCHE





CG1 000 77

178113

RECHTS / RIGHT / DROITE

CG1 000 76

178114

| | |
|---|-----------|
|  Unit weight | 3,82 |
|  color | ■ schwarz |
|  piece unit | 400 Pal |
|  accessories | |



Teile passend zu
parts interchangeable
Pièces adaptables pour

IHC





Schare - Wechselspitzenschare
Share for rev. Point / Soc pour pointe reversilbe

RECHTS / RIGHT / DROITE

CV0 060 70

999 251M

17"

| | |
|---|---------------------|
|  Unit weight | 5,60 |
|  color | ■ schwarz |
|  piece unit | 150 Pal |
|  accessories | 3 x G-1234, 523998V |







Teile passend zu
parts interchangeable
Pièces adaptables pour

IMT - OLT

Schare
Share / Soc

CV0 060 46A

PP4.24.10 30°





| | |
|---|-----------------------|
|  Unit weight | 5,25 |
|  color | ■ schwarz |
|  piece unit | 150 Pal |
|  accessories | 3 x H-1439, LK000009V |



Schare
Share / Soc

CV2 000 16

Schare für Russ (3 Loch)

| | |
|---|-----------------------|
|  Unit weight | 5,50 |
|  color | ■ schwarz |
|  piece unit | 150 Pal |
|  accessories | 3 x B-1240 2700 2607, |



Teile passend zu
parts interchangeable
Pièces adaptables pour

Krone





Anlage

Landside / Contre-Sep

LINKS / LEFT / GAUCHE

CK1 000 15

1231593 KG8/9/10

| | |
|---|---|
|  Unit weight | 2,50 |
|  color |  rot |
|  piece unit | 400 Pal |
|  accessories | |

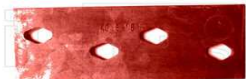





Anlage

Landside / Contre-Sep

RECHTS / RIGHT / DROITE

CK1 000 20

1231643 KG12/14/16

| | |
|---|--|
|  Unit weight | 5,70 |
|  color |  rot |
|  piece unit | 170 Pal |
|  accessories | |







Düngereinlegeschar

Skim Point / Soc de Rasette

LINKS / LEFT / GAUCHE

CK1 000 13

9291900 D12

| | |
|---|---|
|  Unit weight | 1,10 |
|  color |  rot |
|  piece unit | 500 Pal |
|  accessories | 2 x D-1030, 523742V |

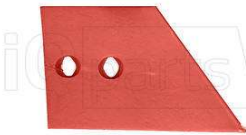





Düngereinlegeschar

Skim Point / Soc de Rasette

LINKS / LEFT / GAUCHE

CK1 000 23

9291910 VD 14

| | |
|---|--|
|  Unit weight | 0,93 |
|  color |  rot |
|  piece unit | 500 Pal |
|  accessories | 2 x D-1030, 523742V |



RECHTS / RIGHT / DROITE

CK1 000 22

VD 14





Düngereinlegeschar

Skim Point / Soc de Rasette

LINKS / LEFT / GAUCHE

CK1 000 25

9291920 VD214 9291921 VD181

| | |
|---|---|
|  Unit weight | 1,10 |
|  color |  rot |
|  piece unit | 500 Pal |
|  accessories | 2 x D-1030, 523742V |



RECHTS / RIGHT / DROITE

CK1 000 24

VD 214 9290920





Meißel - Wechselspitze

Reversible Point / Pointe Reversible

LINKS / LEFT / GAUCHE

CK1 000 33

9291990

| | |
|---|--|
|  Unit weight | 1,08 |
|  color |  rot |
|  piece unit | 500 Pal |
|  accessories | 2 x G-1234, 523998V |



RECHTS / RIGHT / DROITE

CK1 000 32

9290990





Meißel - Wechselspitze

Reversible Point / Pointe Reversible

LINKS / LEFT / GAUCHE

CK1 000 33

M 1010

| | |
|---|---|
|  Unit weight | 1,08 |
|  color |  rot |
|  piece unit | 500 Pal |
|  accessories | 2 x G-1234, 523998V |



RECHTS / RIGHT / DROITE

CK1 000 32

M 1000





Mollblech -Streichblech

Mouldboard / Versoir

RECHTS / RIGHT / DROITE

CK1 000 58

9292110 KG181

| | |
|---|--|
|  Unit weight | 15,50 |
|  color |  rot |
|  piece unit | 50 Pal |
|  accessories | 6 x C-1235, 523997V |



Teile passend zu
parts interchangeable
Pièces adaptables pour

Krone

Mollblech - Streichblech
Mouldboard / Versoir

| LINKS / LEFT / GAUCHE | RECHTS / RIGHT / DROITE |
|-------------------------------------|-------------------------------------|
| CK1 000 43 9293050 KG10SH | CK1 000 42 9292050 KG10SH |

| | |
|---------------|---------------------|
| Unit weight | 9,30 |
| color | rot |
| piece unit | 50 Pal |
| accessories | 6 x C-1235, 523997V |

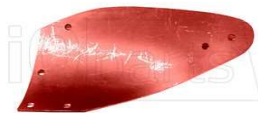

Schare
Share / Soc

| LINKS / LEFT / GAUCHE | RECHTS / RIGHT / DROITE |
|---------------------------------------|---------------------------------------|
| CK1 000 09 9291070 KG12 SSS | CK1 000 08 9290070 KG12 SSS |

| | |
|---------------|---------------------|
| Unit weight | 4,90 |
| color | rot |
| piece unit | 150 Pal |
| accessories | 3 x D-1240, 546200V |



Schare
Share / Soc

| LINKS / LEFT / GAUCHE | RECHTS / RIGHT / DROITE |
|---|---|
| CK1 000 11 9291090 KG14/16SSS | CK1 000 10 9290090 KG14/16SSS |

| | |
|---------------|---------------------|
| Unit weight | 5,50 |
| color | rot |
| piece unit | 150 Pal |
| accessories | 3 x D-1240, 546200V |



Schare - Wechselspitzenschare
Share for rev. Point / Soc pour pointe reversilbe

| LINKS / LEFT / GAUCHE | RECHTS / RIGHT / DROITE |
|---|---|
| CK1 000 37 9291290 KG14/16RSS | CK1 000 36 9690290 KG14/16RSS |

| | |
|---------------|---------------------|
| Unit weight | 5,20 |
| color | rot |
| piece unit | 150 Pal |
| accessories | 3 x D-1240, 546200V |



Verschleißstück - Streichblech - Vorderteil
Wearing part - Mouldboard - Front part / Etrave

| LINKS / LEFT / GAUCHE | RECHTS / RIGHT / DROITE |
|------------------------------------|------------------------------------|
| CK1 000 57 9294350 KG161 | CK1 000 56 9294150 KG161 |

| | |
|---------------|---------------------|
| Unit weight | 2,00 |
| color | rot |
| piece unit | 500 Pal |
| accessories | 3 x C-1235, 523997V |



Verschleißstück - Streichblech - Vorderteil
Wearing part - Mouldboard - Front part / Etrave

| LINKS / LEFT / GAUCHE | RECHTS / RIGHT / DROITE |
|------------------------------------|-----------------------------|
| CK1 000 61 9294360 KG181 | CK1 000 60 KG 181 |

| | |
|---------------|---------------------|
| Unit weight | 1,85 |
| color | rot |
| piece unit | 500 Pal |
| accessories | 3 x C-1235, 523997V |

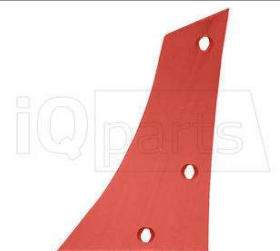

Teile passend zu
parts interchangeable
Pièces adaptables pour

Kuhn / Huard

| | |
|--|-------------------------|
| Anlage Landside / Contre-Sep | |
| LINKS / LEFT / GAUCHE | RECHTS / RIGHT / DROITE |
| CK3 000 30 | CK3 000 29 |
| 278071 | 278070 |

| | |
|-------------|---------------------|
| Unit weight | 3,55 |
| color | ■ schwarz |
| piece unit | 250 Pal |
| accessories | 2 x C-1235, 523997V |



| | |
|--|--|
| Anlage Landside / Contre-Sep | |
| LINKS / LEFT / GAUCHE | |
| CK3 000 62R | |
| 278074 / 278075 | |

| | |
|-------------|---------------------|
| Unit weight | 2,95 |
| color | ■ schwarz |
| piece unit | 350 Pal |
| accessories | 3 x C-1235, 523997V |



| | |
|--|--|
| Anlage Landside / Contre-Sep | |
| LINKS / LEFT / GAUCHE | |
| CK3 000 68R | |
| 278076 / 278077 | |

| | |
|-------------|---------------------|
| Unit weight | 4,70 |
| color | ■ schwarz |
| piece unit | 200 Pal |
| accessories | 3 x C-1235, 523997V |



| | |
|--|-------------------------|
| Anlage Landside / Contre-Sep | |
| LINKS / LEFT / GAUCHE | RECHTS / RIGHT / DROITE |
| CK3 000 69 | CK3 000 68 |
| 278077 | 278076 |

| | |
|-------------|---------------------|
| Unit weight | 4,70 |
| color | ■ schwarz |
| piece unit | 200 Pal |
| accessories | 3 x C-1235, 523997V |



| | |
|--|--|
| Anlage Landside / Contre-Sep | |
| LINKS / LEFT / GAUCHE | |
| CK3 000 64R | |
| 279028 / 279029 | |

| | |
|-------------|---------------------|
| Unit weight | 3,00 |
| color | ■ schwarz |
| piece unit | 350 Pal |
| accessories | 2 x C-1235, 523997V |



| | |
|--|-------------------------|
| Anlage Landside / Contre-Sep | |
| LINKS / LEFT / GAUCHE | RECHTS / RIGHT / DROITE |
| CK3 000 65 | CK3 000 64 |
| 279029 | 279028 |

| | |
|-------------|---------------------|
| Unit weight | 1,18 |
| color | ■ schwarz |
| piece unit | 350 Pal |
| accessories | 2 x C-1235, 523997V |



| | |
|--|-------------------------|
| Anlage Landside / Contre-Sep | |
| LINKS / LEFT / GAUCHE | RECHTS / RIGHT / DROITE |
| CK3 000 73 | CK3 000 72 |
| 279031 | 279030 |

| | |
|-------------|---------------------|
| Unit weight | 3,90 |
| color | ■ schwarz |
| piece unit | 250 Pal |
| accessories | 3 x C-1235, 523997V |



| | |
|--|-------------------------|
| Anlage Landside / Contre-Sep | |
| LINKS / LEFT / GAUCHE | RECHTS / RIGHT / DROITE |
| CK3 000 32 | CK3 000 31 |
| 279115 | 279114 |

| | |
|-------------|---------------------|
| Unit weight | 5,75 |
| color | ■ schwarz |
| piece unit | 150 Pal |
| accessories | 3 x C-1235, 523997V |







Teile passend zu
parts interchangeable
Pièces adaptables pour

Kuhn / Huard

Anlage
Landside / Contre-Sep





| | |
|-----------------------|-------------------------|
| LINKS / LEFT / GAUCHE | RECHTS / RIGHT / DROITE |
| CK3 000 77 | CK3 000 76 |
| 279127 | 279126 |

| | |
|---|---|
|  Unit weight | 2,90 |
|  color |  schwarz |
|  piece unit | 350 Pal |
|  accessories | 3 x C-1235, 523997V |



Anlage
Landside / Contre-Sep





| | |
|-----------------------|-------------------------|
| LINKS / LEFT / GAUCHE | RECHTS / RIGHT / DROITE |
| CK3 000 24 | CK3 000 23 |
| 279131 | 279130 |

| | |
|---|--|
|  Unit weight | 4,70 |
|  color |  schwarz |
|  piece unit | 200 Pal |
|  accessories | 4 x C-1235, 523997V |



Anlage
Landside / Contre-Sep



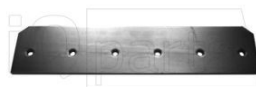

| |
|-------------------|
| CK3 000 61 |
| 279140 |

| | |
|---|---|
|  Unit weight | 5,42 |
|  color |  schwarz |
|  piece unit | 200 Pal |
|  accessories | 3 x G-1234, 523998V |



Anlage
Landside / Contre-Sep





| |
|--------------------|
| CK3 000 61V |
| 279140 12MM |

| | |
|---|--|
|  Unit weight | 6,50 |
|  color |  schwarz |
|  piece unit | 150 Pal |
|  accessories | 3 x G-1234, 523998V |



Anlage
Landside / Contre-Sep





| | |
|-----------------------|-------------------------|
| LINKS / LEFT / GAUCHE | RECHTS / RIGHT / DROITE |
| CK3 001 39 | CK3 001 38 |
| 279149 | 279148 |

| | |
|---|---|
|  Unit weight | 6,55 |
|  color |  schwarz |
|  piece unit | 150 Pal |
|  accessories | 8 x C-1235, 523997V |



Anlage
Landside / Contre-Sep





| |
|-------------------|
| CK3 000 84 |
| 279152 |

| | |
|---|--|
|  Unit weight | 2,35 |
|  color |  schwarz |
|  piece unit | 350 Pal |
|  accessories | 3 x C-1235, 523997V |



Anlage
Landside / Contre-Sep





| |
|--------------------|
| CK3 000 80V |
| 761 108 12MM |

| | |
|---|---|
|  Unit weight | 5,52 |
|  color |  schwarz |
|  piece unit | 200 Pal |
|  accessories | 3 x G-1234, 523998V |



Anlage
Landside / Contre-Sep

| |
|-------------------|
| CK3 000 80 |
| 761108 |

| | |
|---|--|
|  Unit weight | 4,60 |
|  color |  schwarz |
|  piece unit | 200 Pal |
|  accessories | 3 x G-1234, 523998V |



Teile passend zu
parts interchangeable
Pièces adaptables pour







Kuhn / Huard

Anlagenschoner

Landside Protection / Protection de Contre-Sep

CK3 000 97

226100

| | |
|---|---|
|  Unit weight | 4,50 |
|  color |  schwarz |
|  piece | 200 |
|  unit | Pal |
|  accessories | |









Anlagenschoner

Landside Protection / Protection de Contre-Sep

CK3 000 97

226104

| | |
|---|--|
|  Unit weight | 4,50 |
|  color |  schwarz |
|  piece | 200 |
|  unit | Pal |
|  accessories | |









Anlagenschoner

Landside Protection / Protection de Contre-Sep

CK3 001 51

H040 0610

| | |
|---|---|
|  Unit weight | 3,88 |
|  color |  schwarz |
|  piece | 200 |
|  unit | Pal |
|  accessories | 2 x C-1235, 523997V |









Anlagensech

Sword Landside / Ailerons Coutre

CK3 000 98

645255

| | |
|---|--|
|  Unit weight | 0,73 |
|  color |  sandgestrahlt |
|  piece | 1 000 |
|  unit | Pal |
|  accessories | |









Anlagenspitze

Landside top / Pointe de Contre Sep

LINKS / LEFT / GAUCHE

CK3 000 86

223121

| | |
|---|---|
|  Unit weight | 0,90 |
|  color |  schwarz |
|  piece | 1 000 |
|  unit | Pal |
|  accessories | 2 x G-1234, 523998V |



RECHTS / RIGHT / DROITE

CK3 000 85

223120







Anlagenspitze

Landside top / Pointe de Contre Sep

LINKS / LEFT / GAUCHE

CK3 000 67V

279 139 12MM

| | |
|---|--|
|  Unit weight | 1,02 |
|  color |  schwarz |
|  piece | 1 000 |
|  unit | Pal |
|  accessories | 2 x G-1234, 523998V |



RECHTS / RIGHT / DROITE

CK3 000 66V

279 138 12MM







Anlagenspitze

Landside top / Pointe de Contre Sep

LINKS / LEFT / GAUCHE

CK3 000 67

279139

| | |
|---|---|
|  Unit weight | 0,85 |
|  color |  schwarz |
|  piece | 1 000 |
|  unit | Pal |
|  accessories | 2 x G-1234, 523998V |



RECHTS / RIGHT / DROITE

CK3 000 66

279138







Anlagenspitze

Landside top / Pointe de Contre Sep

LINKS / LEFT / GAUCHE

CK3 001 37

279151

| | |
|---|--|
|  Unit weight | 0,70 |
|  color |  schwarz |
|  piece | 1 000 |
|  unit | Pal |
|  accessories | 2 x C-1235, 523997V |

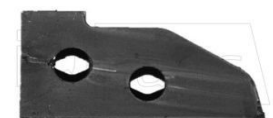

RECHTS / RIGHT / DROITE

CK3 001 36

279150

Teile passend zu
parts interchangeable
Pièces adaptables pour

Kuhn / Huard

Anlagenspitze

Landside top / Pointe de Contre Sep

LINKS / LEFT / GAUCHE





CK3 000 79VD

761 107 12MM Diamant

RECHTS / RIGHT / DROITE

CK3 000 78VD

761 106 12MM Diamant

| | |
|---|---|
|  Unit weight | 1,08 |
|  color |  schwarz |
|  piece unit | 800 Pal |
|  accessories | 1 x G-1240, 523732V |

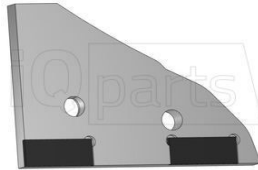

Anlagenspitze

Landside top / Pointe de Contre Sep

LINKS / LEFT / GAUCHE





CK3 000 79

761107

RECHTS / RIGHT / DROITE

CK3 000 78

761106

| | |
|---|--|
|  Unit weight | 0,83 |
|  color |  schwarz |
|  piece unit | 1 000 Pal |
|  accessories | 1 x G-1234, 523998V |



Anlagenspitze

Landside top / Pointe de Contre Sep

LINKS / LEFT / GAUCHE





CK3 000 75

761111

RECHTS / RIGHT / DROITE

CK3 000 74

761110

| | |
|---|---|
|  Unit weight | 0,81 |
|  color |  schwarz |
|  piece unit | |
|  accessories | 2 x G-1234, 523998V |



Anlagenspitze

Landside top / Pointe de Contre Sep

LINKS / LEFT / GAUCHE





CK3 000 75N

761111

RECHTS / RIGHT / DROITE

CK3 000 74N

761110

| | |
|---|--|
|  Unit weight | 0,80 |
|  color |  schwarz |
|  piece unit | 1 000 Pal |
|  accessories | 2 x B-1235 - 3015785, 5 |



Anlagenspitze

Landside top / Pointe de Contre Sep

LINKS / LEFT / GAUCHE





CK3 001 41

761217

RECHTS / RIGHT / DROITE

CK3 001 40

761216

| | |
|---|---|
|  Unit weight | 0,92 |
|  color |  schwarz |
|  piece unit | 1 000 Pal |
|  accessories | 2 x G-1234, 523998V |

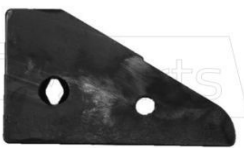

Düngereinlegeblech

Skimmer Board / Versoirs de Rasette

LINKS / LEFT / GAUCHE





CK3 001 04

618105

RECHTS / RIGHT / DROITE

CK3 001 03

618104

| | |
|---|--|
|  Unit weight | 1,95 |
|  color |  schwarz |
|  piece unit | 300 Pal |
|  accessories | 2 x C-1235, 523997V |



Düngereinlegeblech

Skimmer Board / Versoirs de Rasette

LINKS / LEFT / GAUCHE





CK3 000 90

619123

RECHTS / RIGHT / DROITE

CK3 000 89

619122

| | |
|---|---|
|  Unit weight | 3,10 |
|  color |  schwarz |
|  piece unit | 300 Pal |
|  accessories | 2 x C-1235, 523997V |



Düngereinlegeblech

Skimmer Board / Versoirs de Rasette

LINKS / LEFT / GAUCHE





CK3 001 02

619127

RECHTS / RIGHT / DROITE

CK3 001 01

619126

| | |
|---|--|
|  Unit weight | 2,30 |
|  color |  schwarz |
|  piece unit | 300 Pal |
|  accessories | 3 x C-1235, 523997V |



Teile passend zu
parts interchangeable
Pièces adaptables pour

Kuhn / Huard

Düngereinlegeblech

Skimmer Board / Versoirs de Rasette

LINKS / LEFT / GAUCHE





CK3 000 08

619133

RECHTS / RIGHT / DROITE

CK3 000 07

619132

| | |
|---|---|
|  Unit weight | 4,00 |
|  color |  schwarz |
|  piece unit | 250 Pal |
|  accessories | 3 x C-1235, 523997V |







Düngereinlegeblech

Skimmer Board / Versoirs de Rasette

CK3 001 32

619159

| | |
|---|--|
|  Unit weight | 3,40 |
|  color |  schwarz |
|  piece unit | 300 Pal |
|  accessories | 2 x C-1235, 523997V |



Düngereinlegeschar

Skim Point / Soc de Rasette

LINKS / LEFT / GAUCHE





CK3 000 02BV

631 103 10MM

RECHTS / RIGHT / DROITE

CK3 000 01BV

631 102 10MM

| | |
|---|---|
|  Unit weight | 1,60 |
|  color |  schwarz |
|  piece unit | 650 Pal |
|  accessories | 2 x C-1235, 523997V |



Düngereinlegeschar

Skim Point / Soc de Rasette

LINKS / LEFT / GAUCHE





CK3 000 04B

631 109

RECHTS / RIGHT / DROITE

CK3 000 03B

631108/

| | |
|---|--|
|  Unit weight | 1,43 |
|  color |  schwarz |
|  piece unit | 500 Pal |
|  accessories | 2 x G-1234, 523998V |



Düngereinlegeschar

Skim Point / Soc de Rasette

LINKS / LEFT / GAUCHE





CK3 001 53

631019

RECHTS / RIGHT / DROITE

CK3 001 52

631018

| | |
|---|---|
|  Unit weight | 0,78 |
|  color |  schwarz |
|  piece unit | 700 Pal |
|  accessories | 2 x C-1030, 545950V |



Düngereinlegeschar

Skim Point / Soc de Rasette

LINKS / LEFT / GAUCHE





CK3 000 83

631101

RECHTS / RIGHT / DROITE

CK3 000 82

631100

| | |
|---|--|
|  Unit weight | 1,46 |
|  color |  schwarz |
|  piece unit | 500 Pal |
|  accessories | 2 x C-1235, 523997V |

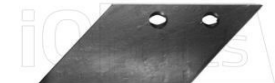

Düngereinlegeschar

Skim Point / Soc de Rasette

LINKS / LEFT / GAUCHE





CK3 000 02

631103 631030

RECHTS / RIGHT / DROITE

CK3 000 01

631102 631031

| | |
|---|---|
|  Unit weight | 1,23 |
|  color |  schwarz |
|  piece unit | 800 Pal |
|  accessories | 2 x C-1235, 523997V |







Düngereinlegeschar

Skim Point / Soc de Rasette

CK3 000 81B

631112

| | |
|---|--|
|  Unit weight | 1,75 |
|  color |  schwarz |
|  piece unit | 500 Pal |
|  accessories | 2 x C-1235, 523997V |

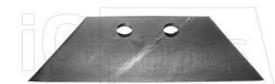

Teile passend zu
parts interchangeable
Pièces adaptables pour

Kuhn / Huard

Meissel - Wechselspitze

Reversible Point / Pointe Reversible

LINKS / LEFT / GAUCHE





CK3 000 26DH

622165 Hardface - Diamant

RECHTS / RIGHT / DROITE

CK3 000 25DH

622164 Hardface - Diamant

| | |
|---|---|
|  Unit weight | 2,15 |
|  color |  schwarz |
|  piece unit | 500 Pal |
|  accessories | 2 x G-1240, 523732V |



Meissel - Wechselspitze

Reversible Point / Pointe Reversible

LINKS / LEFT / GAUCHE





CK3 000 26V

622129 15MM

RECHTS / RIGHT / DROITE

CK3 000 25V

622128 15MM

| | |
|---|--|
|  Unit weight | 2,40 |
|  color |  schwarz |
|  piece unit | 400 Pal |
|  accessories | 2 x G-1234, 523998V |



Meissel - Wechselspitze

Reversible Point / Pointe Reversible

LINKS / LEFT / GAUCHE





CK3 000 26

622129 MARATHON

RECHTS / RIGHT / DROITE

CK3 000 25

622128 MARATHON

| | |
|---|---|
|  Unit weight | 1,84 |
|  color |  schwarz |
|  piece unit | 500 Pal |
|  accessories | 2 x G-1234, 523998V |



Meissel - Wechselspitze

Reversible Point / Pointe Reversible

LINKS / LEFT / GAUCHE





CK3 000 26D

622165 Diamant

RECHTS / RIGHT / DROITE

CK3 000 25D

622164 Diamant

| | |
|---|--|
|  Unit weight | 2,00 |
|  color |  schwarz |
|  piece unit | 500 Pal |
|  accessories | 2 x G-1234, 523998V |



Meissel - Wechselspitze

Reversible Point / Pointe Reversible

LINKS / LEFT / GAUCHE





CK3 000 26V

622175 Olympic

RECHTS / RIGHT / DROITE

CK3 000 25V

622174 Olympic

| | |
|---|---|
|  Unit weight | 2,40 |
|  color |  schwarz |
|  piece unit | 400 Pal |
|  accessories | 2 x G-1234, 523998V |



Mollblech -Streichblech

Mouldboard / Versoir

LINKS / LEFT / GAUCHE





CK3 000 42

616093

RECHTS / RIGHT / DROITE

CK3 000 41

616092

| | |
|---|--|
|  Unit weight | 17,00 |
|  color |  schwarz |
|  piece unit | 50 Pal |
|  accessories | 8 x C-1235, 523997V |



Mollblech -Streichblech

Mouldboard / Versoir

LINKS / LEFT / GAUCHE





CK3 000 42

616105

RECHTS / RIGHT / DROITE

CK3 000 41

616104

| | |
|---|---|
|  Unit weight | 17,00 |
|  color |  schwarz |
|  piece unit | 50 Pal |
|  accessories | 8 x C-1235, 523997V |



Mollblech -Streichblech

Mouldboard / Versoir

LINKS / LEFT / GAUCHE





CK3 000 38

616139

RECHTS / RIGHT / DROITE

CK3 000 37

616138

| | |
|---|--|
|  Unit weight | 19,80 |
|  color |  schwarz |
|  piece unit | 50 Pal |
|  accessories | 7 x C-1235, 523997V |



Teile passend zu
parts interchangeable
Pièces adaptables pour

Kuhn / Huard

Mollblech -Streichblech
Mouldboard / Versoir

| LINKS / LEFT / GAUCHE | RECHTS / RIGHT / DROITE |
|-----------------------------|-----------------------------|
| CK3 000 34 616191 | CK3 000 33 616190 |

| | |
|-------------|---------------------|
| Unit weight | 14,40 |
| color | schwarz |
| piece unit | 50 Pal |
| accessories | 6 x C-1235, 523997V |



Schare
Share / Soc

| LINKS / LEFT / GAUCHE | RECHTS / RIGHT / DROITE |
|-----------------------------|-----------------------------|
| CK3 000 88 625103 | CK3 000 87 625102 |

| | |
|-------------|---------------------|
| Unit weight | 5,05 |
| color | schwarz |
| piece unit | 150 Pal |
| accessories | 3 x C-1435, 546101V |



Schare - Wechselspitzenschare
Share for rev. Point / Soc pour pointe reversilbe

| LINKS / LEFT / GAUCHE | RECHTS / RIGHT / DROITE |
|---------------------------------|---------------------------------|
| CK3 000 20 580885 14" | ck3 000 19 580884 14" |

| | |
|-------------|---------------------|
| Unit weight | 6,98 |
| color | schwarz |
| piece unit | 100 Pal |
| accessories | 4 x C-1435, 546101V |



Schare - Wechselspitzenschare
Share for rev. Point / Soc pour pointe reversilbe

| LINKS / LEFT / GAUCHE | RECHTS / RIGHT / DROITE |
|---------------------------------|---------------------------------|
| CK3 000 22 580887 16" | CK3 000 21 580886 16" |

| | |
|-------------|---------------------|
| Unit weight | 7,50 |
| color | schwarz |
| piece unit | 100 Pal |
| accessories | 4 x C-1435, 546101V |



Schare - Wechselspitzenschare
Share for rev. Point / Soc pour pointe reversilbe

| LINKS / LEFT / GAUCHE | RECHTS / RIGHT / DROITE |
|---------------------------------|---------------------------------|
| CK3 000 20 581141 14" | ck3 000 19 581140 14" |

| | |
|-------------|---------------------|
| Unit weight | 6,98 |
| color | schwarz |
| piece unit | 100 Pal |
| accessories | 4 x C-1435, 546101V |



Schare - Wechselspitzenschare
Share for rev. Point / Soc pour pointe reversilbe

| LINKS / LEFT / GAUCHE | RECHTS / RIGHT / DROITE |
|---------------------------------|---------------------------------|
| CK3 000 22 581417 16" | CK3 000 21 581416 16" |

| | |
|-------------|---------------------|
| Unit weight | 7,50 |
| color | schwarz |
| piece unit | 100 Pal |
| accessories | 4 x C-1435, 546101V |



Schare - Wechselspitzenschare
Share for rev. Point / Soc pour pointe reversilbe

| LINKS / LEFT / GAUCHE | RECHTS / RIGHT / DROITE |
|---------------------------------|---------------------------------|
| CK3 000 20 583103 14" | ck3 000 19 583102 14" |

| | |
|-------------|---------------------|
| Unit weight | 6,98 |
| color | schwarz |
| piece unit | 100 Pal |
| accessories | 4 x C-1435, 546101V |



Schare - Wechselspitzenschare
Share for rev. Point / Soc pour pointe reversilbe

| LINKS / LEFT / GAUCHE | RECHTS / RIGHT / DROITE |
|---------------------------------|---------------------------------|
| CK3 000 22 583819 16" | CK3 000 21 583818 16" |

| | |
|-------------|---------------------|
| Unit weight | 7,50 |
| color | schwarz |
| piece unit | 100 Pal |
| accessories | 4 x C-1435, 546101V |



Teile passend zu
parts interchangeable
Pièces adaptables pour

Kuhn / Huard

Schare - Wechselspitzschare

Share for rev. Point / Soc pour pointe reversilbe

| LINKS / LEFT / GAUCHE | RECHTS / RIGHT / DROITE |
|-----------------------------|-----------------------------|
| CK3 001 19 583893 | CK3 001 18 583892 |

| | |
|-------------|---------------------|
| Unit weight | 6,50 |
| color | schwarz |
| piece unit | 100 Pal |
| accessories | 4 x C-1435, 546101V |



Schare - Wechselspitzschare

Share for rev. Point / Soc pour pointe reversilbe

| LINKS / LEFT / GAUCHE | RECHTS / RIGHT / DROITE |
|--|--|
| CK3 000 12 622135 622167 14" | CK3 000 11 622134 622166 14" |

| | |
|-------------|---------------------|
| Unit weight | 6,45 |
| color | schwarz |
| piece unit | 150 Pal |
| accessories | 4 x C-1435, 546101V |



Schare - Wechselspitzschare

Share for rev. Point / Soc pour pointe reversilbe

| LINKS / LEFT / GAUCHE | RECHTS / RIGHT / DROITE |
|---|---------------------------------|
| CK3 000 14 622137 622173 622213 16" | CK3 000 13 622212 16" |

| | |
|-------------|---------------------|
| Unit weight | 6,80 |
| color | schwarz |
| piece unit | 150 Pal |
| accessories | 4 x C-1435, 546101V |



Schare - Wechselspitzschare

Share for rev. Point / Soc pour pointe reversilbe

| LINKS / LEFT / GAUCHE | RECHTS / RIGHT / DROITE |
|---------------------------------|---------------------------------|
| CK3 000 16 622141 14" | CK3 000 15 622140 14" |

| | |
|-------------|---------------------|
| Unit weight | 6,30 |
| color | schwarz |
| piece unit | 150 Pal |
| accessories | 3 x C-1435, 546101V |



Schare - Wechselspitzschare

Share for rev. Point / Soc pour pointe reversilbe

| LINKS / LEFT / GAUCHE | RECHTS / RIGHT / DROITE |
|-----------------------------|-----------------------------|
| CK3 000 18 622143 | CK3 000 17 622142 |

| | |
|-------------|---------------------|
| Unit weight | 6,60 |
| color | schwarz |
| piece unit | 150 Pal |
| accessories | 4 x C-1435, 546101V |

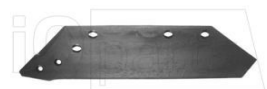

Schare - Wechselspitzschare

Share for rev. Point / Soc pour pointe reversilbe

| LINKS / LEFT / GAUCHE | RECHTS / RIGHT / DROITE |
|-----------------------------|-----------------------------|
| CK3 000 94 622235 | CK3 000 93 622234 |

| | |
|-------------|------------|
| Unit weight | 5,70 |
| color | schwarz |
| piece unit | 150 Pal |
| accessories | |



Schare - Wechselspitzschare

Share for rev. Point / Soc pour pointe reversilbe

| LINKS / LEFT / GAUCHE | RECHTS / RIGHT / DROITE |
|--------------------------------------|--------------------------------------|
| CK3 000 92 622331 H0401870 | CK3 000 91 622330 H0401860 |

| | |
|-------------|---------------------|
| Unit weight | 6,00 |
| color | schwarz |
| piece unit | 150 Pal |
| accessories | 4 x C-1435, 546101V |



Schare - Wechselspitzschare

Share for rev. Point / Soc pour pointe reversilbe

| LINKS / LEFT / GAUCHE | RECHTS / RIGHT / DROITE |
|--------------------------------|--------------------------------|
| CK3 001 35 H040 1910 | CK3 001 34 H040 1900 |

| | |
|-------------|---------------------|
| Unit weight | 7,20 |
| color | schwarz |
| piece unit | 150 Pal |
| accessories | 4 x C-1435, 546101V |



Teile passend zu
parts interchangeable
Pièces adaptables pour

Kuhn / Huard

Scharsech

Coulter Knife / Coutre Incorporé

CK3 001 33

270 060

| | |
|-------------|--------------|
| Unit weight | 0,82 |
| color | sandgestraht |
| piece unit | |
| accessories | |



Streichschiene

Tailpress / Rallonge de Versoir

LINKS / LEFT / GAUCHE

CK3 000 58

648103

RECHTS / RIGHT / DROITE

CK3 000 57

648102

| | |
|-------------|------------|
| Unit weight | 2,20 |
| color | schwarz |
| piece unit | 500 Pal |
| accessories | |



Streifen

Strips for slated body / Lame pour clair Voie

LINKS / LEFT / GAUCHE

CK3 001 06

H040 4660

RECHTS / RIGHT / DROITE

CK3 001 05

H040 4650

| | |
|-------------|---------------------|
| Unit weight | 3,65 |
| color | schwarz |
| piece unit | 250 Pal |
| accessories | 2 x C-1235, 523997V |



Streifen

Strips for slated body / Lame pour clair Voie

LINKS / LEFT / GAUCHE

CK3 001 08

H040 4680

RECHTS / RIGHT / DROITE

CK3 001 07

H040 4670

| | |
|-------------|---------------------|
| Unit weight | 4,45 |
| color | schwarz |
| piece unit | 200 Pal |
| accessories | 2 x C-1235, 523997V |



Streifen

Strips for slated body / Lame pour clair Voie

LINKS / LEFT / GAUCHE

CK3 001 10

H040 4700

RECHTS / RIGHT / DROITE

CK3 001 09

H040 4690

| | |
|-------------|---------------------|
| Unit weight | 3,40 |
| color | schwarz |
| piece unit | 300 Pal |
| accessories | 2 x C-1235, 523997V |



Streifen

Strips for slated body / Lame pour clair Voie

LINKS / LEFT / GAUCHE

CK3 001 12

H040 4720

RECHTS / RIGHT / DROITE

CK3 001 11

H040 4710

| | |
|-------------|---------------------|
| Unit weight | 3,05 |
| color | schwarz |
| piece unit | 300 Pal |
| accessories | 2 x C-1235, 523997V |



Streifen

Strips for slated body / Lame pour clair Voie

LINKS / LEFT / GAUCHE

CK3 001 06

617101

RECHTS / RIGHT / DROITE

CK3 001 05

617100

| | |
|-------------|---------------------|
| Unit weight | 3,65 |
| color | schwarz |
| piece unit | 250 Pal |
| accessories | 2 x C-1235, 523997V |



Streifen

Strips for slated body / Lame pour clair Voie

LINKS / LEFT / GAUCHE

CK3 001 08

617103

RECHTS / RIGHT / DROITE

CK3 001 07

617102

| | |
|-------------|---------------------|
| Unit weight | 4,45 |
| color | schwarz |
| piece unit | 200 Pal |
| accessories | 2 x C-1235, 523997V |



Teile passend zu
parts interchangeable
Pièces adaptables pour

Kuhn / Huard

Streifen

Strips for slated body / Lame pour clair Voie

| LINKS / LEFT / GAUCHE | RECHTS / RIGHT / DROITE |
|-----------------------|-------------------------|
| CK3 001 10 | CK3 001 09 |
| 617105 | 617104 |

| | |
|-------------|---------------------|
| Unit weight | 3,40 |
| color | schwarz |
| piece unit | 300 Pal |
| accessories | 2 x C-1235, 523997V |



Streifen

Strips for slated body / Lame pour clair Voie

| LINKS / LEFT / GAUCHE | RECHTS / RIGHT / DROITE |
|-----------------------|-------------------------|
| CK3 001 12 | CK3 001 11 |
| 617107 | 617106 |

| | |
|-------------|---------------------|
| Unit weight | 3,05 |
| color | schwarz |
| piece unit | 300 Pal |
| accessories | 2 x C-1235, 523997V |



Streifen

Strips for slated body / Lame pour clair Voie

| LINKS / LEFT / GAUCHE | RECHTS / RIGHT / DROITE |
|-----------------------|-------------------------|
| CK3 001 23 | CK3 001 22 |
| H040 3190 | H040 3180 |

| | |
|-------------|---------------------|
| Unit weight | 3,95 |
| color | schwarz |
| piece unit | 250 Pal |
| accessories | 2 x C-1235, 523997V |

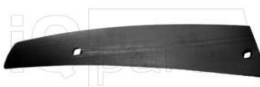

Streifen

Strips for slated body / Lame pour clair Voie

| LINKS / LEFT / GAUCHE | RECHTS / RIGHT / DROITE |
|-----------------------|-------------------------|
| CK3 001 25 | CK3 001 24 |
| H040 3210 | H040 3200 |

| | |
|-------------|---------------------|
| Unit weight | 4,47 |
| color | schwarz |
| piece unit | 200 Pal |
| accessories | 2 x C-1235, 523997V |



Streifen

Strips for slated body / Lame pour clair Voie

| LINKS / LEFT / GAUCHE | RECHTS / RIGHT / DROITE |
|-----------------------|-------------------------|
| CK3 001 27 | CK3 001 26 |
| H040 3230 | H040 3220 |

| | |
|-------------|---------------------|
| Unit weight | 5,30 |
| color | schwarz |
| piece unit | 200 Pal |
| accessories | 2 x C-1235, 523997V |



Streifen

Strips for slated body / Lame pour clair Voie

| LINKS / LEFT / GAUCHE | RECHTS / RIGHT / DROITE |
|-----------------------|-------------------------|
| CK3 001 29 | CK3 001 28 |
| H040 3250 | H040 3240 |

| | |
|-------------|---------------------|
| Unit weight | 7,20 |
| color | schwarz |
| piece unit | 150 Pal |
| accessories | 2 x C-1235, 523997V |



Verschleißstück - Streichblech - Vorderteil

Wearing part - Moulboard - Front part / Etrave

| LINKS / LEFT / GAUCHE | RECHTS / RIGHT / DROITE |
|-----------------------|-------------------------|
| CK3 000 50 | CK3 000 49 |
| 619039 | 619038 |

| | |
|-------------|---------------------|
| Unit weight | 2,03 |
| color | schwarz |
| piece unit | 500 Pal |
| accessories | 2 x C-1235, 523997V |



Verschleißstück - Streichblech - Vorderteil

Wearing part - Moulboard - Front part / Etrave

| LINKS / LEFT / GAUCHE | RECHTS / RIGHT / DROITE |
|------------------------|-------------------------|
| CK3 000 50H | CK3 000 49H |
| 619039 <i>hardface</i> | 619038 <i>hardface</i> |

| | |
|-------------|---------------------|
| Unit weight | 2,10 |
| color | schwarz |
| piece unit | 500 Pal |
| accessories | 2 x C-1235, 523997V |

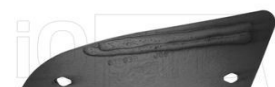

Teile passend zu
parts interchangeable
Pièces adaptables pour

Kuhn / Huard

Verschleißstück - Streichblech - Vorderteil

Wearing part - Moulboard - Front part / Etrave

LINKS / LEFT / GAUCHE

CK3 000 54

619061

RECHTS / RIGHT / DROITE

CK3 000 53

619060

| | |
|-------------|---------------------|
| Unit weight | 1,54 |
| color | schwarz |
| piece unit | 500 Pal |
| accessories | 2 x C-1235, 523997V |



Verschleißstück - Streichblech - Vorderteil

Wearing part - Moulboard - Front part / Etrave

LINKS / LEFT / GAUCHE

CK3 000 56

619069

RECHTS / RIGHT / DROITE

CK3 000 55

619068

| | |
|-------------|---------------------|
| Unit weight | 1,30 |
| color | schwarz |
| piece unit | 500 Pal |
| accessories | 2 x C-1235, 523997V |



Verschleißstück - Streichblech - Vorderteil

Wearing part - Moulboard - Front part / Etrave

LINKS / LEFT / GAUCHE

CK3 000 52

619121 LH4

RECHTS / RIGHT / DROITE

CK3 000 51

619120 RH4

| | |
|-------------|---------------------|
| Unit weight | 2,30 |
| color | schwarz |
| piece unit | 400 Pal |
| accessories | 3 x C-1235, 523997V |



Verschleißstück - Streichblech - Vorderteil

Wearing part - Moulboard - Front part / Etrave

LINKS / LEFT / GAUCHE

CK3 000 52

619169

RECHTS / RIGHT / DROITE

CK3 000 51

619168

| | |
|-------------|---------------------|
| Unit weight | 2,30 |
| color | schwarz |
| piece unit | 400 Pal |
| accessories | 3 x C-1235, 523997V |



Verschleißstück - Streichblech - Vorderteil

Wearing part - Moulboard - Front part / Etrave

LINKS / LEFT / GAUCHE

CK3 000 46

619173

RECHTS / RIGHT / DROITE

CK3 000 45

619172

| | |
|-------------|---------------------|
| Unit weight | 2,75 |
| color | schwarz |
| piece unit | 400 Pal |
| accessories | 4 x C-1235, 523997V |



Verschleißstück - Streichblech - Vorderteil

Wearing part - Moulboard - Front part / Etrave

LINKS / LEFT / GAUCHE

CK3 000 48V

619201 10MM H0411790V

RECHTS / RIGHT / DROITE

CK3 000 47V

619200 10MM H0401780V

| | |
|-------------|---------------------|
| Unit weight | 1,70 |
| color | schwarz |
| piece unit | 500 Pal |
| accessories | 2 x C-1235, 523997V |



Verschleißstück - Streichblech - Vorderteil

Wearing part - Moulboard - Front part / Etrave

LINKS / LEFT / GAUCHE

CK3 000 48

619201 H040179

RECHTS / RIGHT / DROITE

CK3 000 47

619200 H040178

| | |
|-------------|---------------------|
| Unit weight | 1,55 |
| color | schwarz |
| piece unit | 500 Pal |
| accessories | 2 x C-1235, 523997V |



Verschleißstück - Streichblech - Vorderteil

Wearing part - Moulboard - Front part / Etrave

LINKS / LEFT / GAUCHE

CK3 001 31

619279

RECHTS / RIGHT / DROITE

CK3 001 30

619278

| | |
|-------------|---------------------|
| Unit weight | 2,35 |
| color | schwarz |
| piece unit | 400 Pal |
| accessories | 4 x C-1235, 523997V |



Teile passend zu
parts interchangeable
Pièces adaptables pour

Kuhn / Huard

Verschleißstück - Streichblech - Vorderteil
Wearing part - Moulboard - Front part / Etrave

LINKS / LEFT / GAUCHE





CK3 001 21

H040 3530

RECHTS / RIGHT / DROITE

CK3 001 20

H040 3520





| | |
|---|---|
|  Unit weight | 2,60 |
|  color |  schwarz |
|  piece unit | 400 Pal |
|  accessories | 4 x C-1235, 523997V |



Teile passend zu
parts interchangeable
Pièces adaptables pour





Kverneland

| | | |
|-----------------------|-------------------------|--------------|
| Anlage | | 1 - 4 |
| Landside / Contre-Sep | | |
| LINKS / LEFT / GAUCHE | RECHTS / RIGHT / DROITE | |
| CKO 000 20 | CKO 000 19 | |
| 063604 | 063613 | |

| | |
|---|---|
|  Unit weight | 5,95 |
|  color |  rot |
|  piece unit | 150 Pal |
|  accessories | 1 x G-1234, 523998V 1 x F-1640 PK800013 M |







| | | |
|-----------------------|-------------------------|--------------|
| Anlage | | 1 - 4 |
| Landside / Contre-Sep | | |
| LINKS / LEFT / GAUCHE | RECHTS / RIGHT / DROITE | |
| CKO 000 22 | CKO 000 21 | |
| 063606 | 063615 | |

| | |
|---|--|
|  Unit weight | 4,00 |
|  color |  rot |
|  piece unit | 250 Pal |
|  accessories | 1 x G-1234, 523998V 1 x F-1640 PK800013 M |







| | |
|-----------------------|--|
| Anlage | |
| Landside / Contre-Sep | |
| CKO 000 26 | |
| 063610 | |

| | |
|---|---|
|  Unit weight | 5,30 |
|  color |  rot |
|  piece unit | 200 Pal |
|  accessories | |







| | |
|-----------------------|--|
| Anlage | |
| Landside / Contre-Sep | |
| CKO 000 46 | |
| 063611 | |

| | |
|---|--|
|  Unit weight | 8,60 |
|  color |  rot |
|  piece unit | 150 Pal |
|  accessories | |







| | | |
|-----------------------|--|-------------------|
| Anlage | | 6 - 20, 30 |
| Landside / Contre-Sep | | |
| CKO 000 84 | | |
| 073608 12MM | | |

| | |
|---|---|
|  Unit weight | 5,70 |
|  color |  rot |
|  piece unit | 150 Pal |
|  accessories | 6 x F-1434, 523999V |







| | | |
|-----------------------|--|-------------------|
| Anlage | | 6 - 20, 30 |
| Landside / Contre-Sep | | |
| CKO 000 85 | | |
| 073609 12MM | | |

| | |
|---|--|
|  Unit weight | 8,50 |
|  color |  rot |
|  piece unit | 100 Pal |
|  accessories | 6 x F-1434, 523999V |





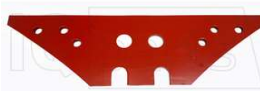

| | |
|-----------------------|--|
| Anlage | |
| Landside / Contre-Sep | |
| CKO 000 84 | |
| 073610 12MM | |

| | |
|---|---|
|  Unit weight | 5,70 |
|  color |  rot |
|  piece unit | 150 Pal |
|  accessories | 6 x F-1434, 523999V |



| | | |
|-----------------------|-------------------------|--|
| Anlage | | |
| Landside / Contre-Sep | | |
| LINKS / LEFT / GAUCHE | RECHTS / RIGHT / DROITE | |
| CKO 000 50 | CKO 000 49 | |
| 073611 | 073610 | |

| | |
|---|--|
|  Unit weight | 8,00 |
|  color |  rot |
|  piece unit | 150 Pal |
|  accessories | |



Teile passend zu
parts interchangeable
Pièces adaptables pour





Kverneland

Anlagenschoner

Landside Protection / Protection de Contre-Sep

CKO 001 00

063600A

| | |
|---|---------------------|
|  Unit weight | 1,50 |
|  color | rot |
|  piece | 700 |
|  unit | Pal |
|  accessories | 2 x F-1434, 523999V |







Anlagenschoner

Landside Protection / Protection de Contre-Sep

CKO 000 47

063601A

| | |
|---|---------------------|
|  Unit weight | 3,85 |
|  color | rot |
|  piece | 250 |
|  unit | Pal |
|  accessories | 2 x G-1234, 523998V |







Anlagenschoner

Landside Protection / Protection de Contre-Sep

CKO 000 99

073614

| | |
|---|---------------------|
|  Unit weight | 0,90 |
|  color | rot |
|  piece | 700 |
|  unit | Pal |
|  accessories | 2 x F-1434, 523999V |







Anlagensech

Sword Landside / Ailerons Coutre

LINKS / LEFT / GAUCHE

CKO 001 11

073089

| | |
|---|------|
|  Unit weight | 3,50 |
|  color | rot |
|  piece | 300 |
|  unit | Pal |
|  accessories | |

RECHTS / RIGHT / DROITE

CKO 001 10

073088







Anlagensech

Sword Landside / Ailerons Coutre

LINKS / LEFT / GAUCHE

CKO 001 11

084321

| | |
|---|------|
|  Unit weight | 3,50 |
|  color | rot |
|  piece | 300 |
|  unit | Pal |
|  accessories | |

RECHTS / RIGHT / DROITE

CKO 001 10

084320







Düngereinlegeblech

Skimmer Board / Versoirs de Rasette

LINKS / LEFT / GAUCHE

CKO 001 02

066881

| | |
|---|---------------------|
|  Unit weight | 1,89 |
|  color | grün |
|  piece | 300 |
|  unit | Pal |
|  accessories | 2 x C-1030, 545950V |

RECHTS / RIGHT / DROITE

CKO 001 01

066880







Düngereinlegeblech

Skimmer Board / Versoirs de Rasette

LINKS / LEFT / GAUCHE

CKO 001 13

073301

| | |
|---|---------------------|
|  Unit weight | 3,32 |
|  color | grün |
|  piece | 300 |
|  unit | Pal |
|  accessories | 2 x C-1235, 523997V |

RECHTS / RIGHT / DROITE

CKO 001 12

073300







Düngereinlegeblech

Skimmer Board / Versoirs de Rasette

LINKS / LEFT / GAUCHE

CKO 000 95

076813

| | |
|---|---------------------|
|  Unit weight | 2,45 |
|  color | grün |
|  piece | 300 |
|  unit | Pal |
|  accessories | 2 x C-1030, 545950V |

RECHTS / RIGHT / DROITE

CKO 000 94

076812



Teile passend zu
parts interchangeable
Pièces adaptables pour

Kverneland

Düngereinlegeschar

Skim Point / Soc de Rasette

LINKS / LEFT / GAUCHE





CKO 000 71BV

066 869V

RECHTS / RIGHT / DROITE

CKO 000 70BV

066 868V

| | |
|---|--|
|  Unit weight | 1,85 |
|  color |  grün |
|  piece unit | 500 Pal |
|  accessories | 2 x C-1030, 545950V |



Düngereinlegeschar

Skim Point / Soc de Rasette

LINKS / LEFT / GAUCHE





CKO 001 08

066852

RECHTS / RIGHT / DROITE

CKO 001 07

056852

| | |
|---|---|
|  Unit weight | 1,25 |
|  color |  grün |
|  piece unit | 800 Pal |
|  accessories | 2 x C-1030, 545950V |







Düngereinlegeschar

Skim Point / Soc de Rasette

CKO 001 41

066868 066869

| | |
|---|--|
|  Unit weight | 1,34 |
|  color |  grün |
|  piece unit | 500 Pal |
|  accessories | |



Düngereinlegeschar

Skim Point / Soc de Rasette

LINKS / LEFT / GAUCHE





CKO 000 71

066869

RECHTS / RIGHT / DROITE

CKO 000 70

066868

| | |
|---|---|
|  Unit weight | 1,48 |
|  color |  grün |
|  piece unit | 500 Pal |
|  accessories | 2 x C-1030, 545950V |



Düngereinlegeschar

Skim Point / Soc de Rasette





LINKS / LEFT / GAUCHE
CKO 000 29

066873

RECHTS / RIGHT / DROITE

CKO 000 28

056873

| | |
|---|--|
|  Unit weight | 1,02 |
|  color |  grün |
|  piece unit | 700 Pal |
|  accessories | 2 x C-1030, 545950V |



Halteplatte

Retaining Plate /

6-9, 12-15

LINKS / LEFT / GAUCHE





CKO 001 15

073311

RECHTS / RIGHT / DROITE

CKO 001 14

073310

| | |
|---|---|
|  Unit weight | 2,25 |
|  color |  grün |
|  piece unit | 400 Pal |
|  accessories | |



Meissel - Wechselspitze

Reversible Point / Pointe Reversible





LINKS / LEFT / GAUCHE
CKO 000 04DH

063090 Hardface - Diamant

RECHTS / RIGHT / DROITE

CKO 000 03DH

053090 Hardface-Diamant

| | |
|---|--|
|  Unit weight | 1,70 |
|  color |  grün |
|  piece unit | 500 Pal |
|  accessories | 2 x G-1250, 523732AV |



Meissel - Wechselspitze

Reversible Point / Pointe Reversible

6-9, 12-15

LINKS / LEFT / GAUCHE





CKO 000 04

063090

RECHTS / RIGHT / DROITE

CKO 000 03

053090

| | |
|---|---|
|  Unit weight | 1,33 |
|  color |  grün |
|  piece unit | 500 Pal |
|  accessories | 2 x G-1234, 523998V |



Teile passend zu
parts interchangeable
Pièces adaptables pour

Kverneland

Meissel - Wechselspitze

Reversible Point / Pointe Reversible

LINKS / LEFT / GAUCHE





CKO 000 04V

063090 15 mm

RECHTS / RIGHT / DROITE

CKO 000 03V

053090 15 mm

| | |
|---|---------------------|
|  Unit weight | 1,75 |
|  color | grün |
|  piece unit | 500 Pal |
|  accessories | 2 x G-1240, 523732V |



Meissel - Wechselspitze

Reversible Point / Pointe Reversible

LINKS / LEFT / GAUCHE





CKO 000 04D

063090 Diamant

RECHTS / RIGHT / DROITE

CKO 000 03D

053090 Diamant

| | |
|---|----------------------|
|  Unit weight | 1,50 |
|  color | grün |
|  piece unit | 500 Pal |
|  accessories | 2 x G-1250, 523732AV |



6-9, 12-15

Meissel - Wechselspitze

Reversible Point / Pointe Reversible

LINKS / LEFT / GAUCHE





CKO 000 04VH

063090VH 15MM HARDFACE

RECHTS / RIGHT / DROITE

CKO 000 03VH

053090VH 15MM HARDFACE

| | |
|---|---------------------|
|  Unit weight | 1,80 |
|  color | grün |
|  piece unit | 500 Pal |
|  accessories | 2 x G-1240, 523732V |

Mollblech -Streichblech

Mouldboard / Versoir

LINKS / LEFT / GAUCHE

CKO 000 73

073287





14"

RECHTS / RIGHT / DROITE

CKO 000 72

073286

14"

| | |
|---|----------------------|
|  Unit weight | 20,30 |
|  color | rot |
|  piece unit | 50 Pal |
|  accessories | 10 x C-1235, 523997V |



8

Mollblech -Streichblech

Mouldboard / Versoir

LINKS / LEFT / GAUCHE

CKO 000 79

073291





14"

RECHTS / RIGHT / DROITE

CKO 000 78

073290

14"

| | |
|---|----------------------|
|  Unit weight | 20,30 |
|  color | rot |
|  piece unit | 50 Pal |
|  accessories | 10 x C-1235, 523997V |







Mollblech -Streichblech

Mouldboard / Versoir

CKO 001 21

083228

| | |
|---|----------------------|
|  Unit weight | 24,00 |
|  color | rot |
|  piece unit | 50 Pal |
|  accessories | 10 x C-1235, 523997V |







Mollblech -Streichblech

Mouldboard / Versoir

CKO 001 22

083229

| | |
|---|----------------------|
|  Unit weight | 24,00 |
|  color | rot |
|  piece unit | 50 Pal |
|  accessories | 10 x C-1235, 523997V |



Ploughbody

Ploughbody /

LINKS / LEFT / GAUCHE





CKO 001 51

073412 body 8, 9, 28

RECHTS / RIGHT / DROITE

CKO 001 50

073411 body 8, 9, 28

| | |
|---|-------|
|  Unit weight | 11,40 |
|  color | rot |
|  piece unit | |
|  accessories | |

Teile passend zu
parts interchangeable
Pièces adaptables pour

Kverneland

Schare

Share / Soc

LINKS / LEFT / GAUCHE





CKO 000 42

073023

RECHTS / RIGHT / DROITE

CKO 000 41

073022

| | |
|---|--|
|  Unit weight | 4,00 |
|  color |  grün |
|  piece unit | 150 Pal |
|  accessories | 4 x G-1234, 523998V |



Schare - Wechselspitzenschare

Share for rev. Point / Soc pour pointe reversilbe

LINKS / LEFT / GAUCHE





CKO 000 12

063016

RECHTS / RIGHT / DROITE

CKO 000 11

063013

| | |
|---|---|
|  Unit weight | 4,00 |
|  color |  grün |
|  piece unit | 150 Pal |
|  accessories | 4 x G-1234, 523998V |



Schare - Wechselspitzenschare

Share for rev. Point / Soc pour pointe reversilbe

LINKS / LEFT / GAUCHE





CKO 000 02

063017

RECHTS / RIGHT / DROITE

CKO 000 01

063014 063013

| | |
|---|--|
|  Unit weight | 4,95 |
|  color |  grün |
|  piece unit | 150 Pal |
|  accessories | 4 x G-1234, 523998V |



Schare - Wechselspitzenschare

Share for rev. Point / Soc pour pointe reversilbe

LINKS / LEFT / GAUCHE





CKO 000 06

063018

RECHTS / RIGHT / DROITE

CKO 000 05

063015 (063001)

| | |
|---|---|
|  Unit weight | 5,30 |
|  color |  grün |
|  piece unit | 150 Pal |
|  accessories | 4 x G-1234, 523998V |



Schare - Wechselspitzenschare

Share for rev. Point / Soc pour pointe reversilbe

LINKS / LEFT / GAUCHE

CKO 000 36

073003





14"

RECHTS / RIGHT / DROITE

CKO 000 35

073002

14"

| | |
|---|--|
|  Unit weight | 5,00 |
|  color |  grün |
|  piece unit | 150 Pal |
|  accessories | 4 x F-1434, 523999V |



Schare - Wechselspitzenschare

Share for rev. Point / Soc pour pointe reversilbe

LINKS / LEFT / GAUCHE

CKO 000 36V

073003 12 mm





14"

RECHTS / RIGHT / DROITE

CKO 000 35V

073002 12 mm

14"

| | |
|---|---|
|  Unit weight | 5,75 |
|  color |  grün |
|  piece unit | 150 Pal |
|  accessories | 4 x F-1434, 523999V |



Schare - Wechselspitzenschare

Share for rev. Point / Soc pour pointe reversilbe

LINKS / LEFT / GAUCHE

CKO 000 38

073005





16"

RECHTS / RIGHT / DROITE

CKO 000 37

073004

16"

| | |
|---|--|
|  Unit weight | 5,50 |
|  color |  grün |
|  piece unit | 150 Pal |
|  accessories | 4 x F-1434, 523999V |



Schare - Wechselspitzenschare

Share for rev. Point / Soc pour pointe reversilbe

LINKS / LEFT / GAUCHE

CKO 000 38V

073005 12 mm





16"

RECHTS / RIGHT / DROITE

CKO 000 37V

073004 12mm

16"

| | |
|---|---|
|  Unit weight | 6,35 |
|  color |  grün |
|  piece unit | 150 Pal |
|  accessories | 4 x F-1434, 523999V |



Teile passend zu
parts interchangeable
Pièces adaptables pour

Kverneland

Schare - Wechselspitzschare Nr.6-9

Share for rev. Point / Soc pour pointe reversilbe

| LINKS / LEFT / GAUCHE | RECHTS / RIGHT / DROITE |
|-----------------------|-------------------------|
| CKO 000 57 | CKO 000 56 |
| 073007 18" | 073006 Nr.6-9 18" |

| | |
|-------------|---|
| Unit weight | 6,70 |
| color | ■ grün |
| piece unit | 150 Pal |
| accessories | 4 x F-1434, 523999V |



Schare - Wechselspitzschare Nr.6-9

Share for rev. Point / Soc pour pointe reversilbe

| LINKS / LEFT / GAUCHE | RECHTS / RIGHT / DROITE |
|-----------------------|-------------------------|
| CKO 000 57V | CKO 000 56V |
| 073007 12 mm 18" | 073006 12 mm 18" |

| | |
|-------------|---|
| Unit weight | 7,20 |
| color | ■ grün |
| piece unit | 150 Pal |
| accessories | 4 x F-1434, 523999V |



Schare - Wechselspitzschare 9, 12-15, 19, 30

Share for rev. Point / Soc pour pointe reversilbe

| LINKS / LEFT / GAUCHE | RECHTS / RIGHT / DROITE |
|-----------------------|-------------------------|
| CKO 000 75 | CKO 000 74 |
| 073057 16" | 073056 16" |

| | |
|-------------|---|
| Unit weight | 5,15 |
| color | ■ grün |
| piece unit | 150 Pal |
| accessories | 4 x F-1434, 523999V |



Schare - Wechselspitzschare 12-15, 30

Share for rev. Point / Soc pour pointe reversilbe

| LINKS / LEFT / GAUCHE | RECHTS / RIGHT / DROITE |
|-----------------------|-------------------------|
| CKO 000 77 | CKO 000 76 |
| 073081 18" | 073080 18" |

| | |
|-------------|---|
| Unit weight | 6,30 |
| color | ■ grün |
| piece unit | 150 Pal |
| accessories | 4 x F-1434, 523999V |



Schare - Wechselspitzschare

Share for rev. Point / Soc pour pointe reversilbe

| LINKS / LEFT / GAUCHE | RECHTS / RIGHT / DROITE |
|-----------------------|-------------------------|
| CKO 000 77V | CKO 000 76V |
| 073081 12 mm 18" | 073080 12 mm 18" |

| | |
|-------------|---|
| Unit weight | 6,35 |
| color | ■ grün |
| piece unit | 150 Pal |
| accessories | 4 x F-1434, 523999V |



Scharsech

Coulter Knife / Coutre Incorporé

| LINKS / LEFT / GAUCHE | RECHTS / RIGHT / DROITE |
|-----------------------|-------------------------|
| CKO 000 59 | CKO 000 58 |
| 073092 Nr.6-9, 12-15 | 073091 Nr.6-9, 12-15 |

| | |
|-------------|--|
| Unit weight | 0,80 |
| color | ■ rot |
| piece unit | 700 Pal |
| accessories | |



Streichschiene

Tailpress / Rallonge de Versoir

| LINKS / LEFT / GAUCHE | RECHTS / RIGHT / DROITE |
|-----------------------|-------------------------|
| CKO 000 89 | CKO 000 88 |
| 063388 | 053387 |

| | |
|-------------|--|
| Unit weight | 1,92 |
| color | ■ rot |
| piece unit | 500 Pal |
| accessories | |



Streifen

Strips for slated body / Lame pour clair Voie

| LINKS / LEFT / GAUCHE | RECHTS / RIGHT / DROITE |
|-----------------------|-------------------------|
| CKO 001 28 | CKO 001 27 |
| 083221 | 083211 |

| | |
|-------------|--|
| Unit weight | 6,90 |
| color | ■ rot |
| piece unit | 150 Pal |
| accessories | 2 x C-1235, 523997V |

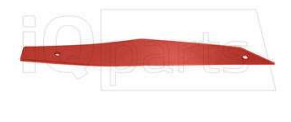

Teile passend zu
parts interchangeable
Pièces adaptables pour

Kverneland

Streifen

Strips for slated body / Lame pour clair Voie

LINKS / LEFT / GAUCHE RECHTS / RIGHT / DROITE

CKO 001 30

CKO 001 29

083222

083212

| | |
|-------------|---------------------|
| Unit weight | 5,25 |
| color | rot |
| piece unit | 150 Pal |
| accessories | 2 x C-1235, 523997V |



Streifen

Strips for slated body / Lame pour clair Voie

LINKS / LEFT / GAUCHE RECHTS / RIGHT / DROITE

CKO 001 32

CKO 001 31

083223

083213

| | |
|-------------|---------------------|
| Unit weight | 4,35 |
| color | rot |
| piece unit | 200 Pal |
| accessories | 2 x C-1235, 523997V |



Streifen

Strips for slated body / Lame pour clair Voie

LINKS / LEFT / GAUCHE RECHTS / RIGHT / DROITE

CKO 001 34

CKO 001 33

083224

083214

| | |
|-------------|---------------------|
| Unit weight | 3,55 |
| color | rot |
| piece unit | 300 Pal |
| accessories | 4 x C-1235, 523997V |



Verschleißstück - Streichblech - Vorderteil

Nr1-4

Wearing part - Moulboard - Front part / Etrave

LINKS / LEFT / GAUCHE RECHTS / RIGHT / DROITE

CKO 000 61

CKO 000 60

063250

063240 Nr.1-4

| | |
|-------------|---------------------|
| Unit weight | 1,05 |
| color | rot |
| piece unit | 500 Pal |
| accessories | 1 x C-1235, 523997V |



Verschleißstück - Streichblech - Vorderteil

9, 19

Wearing part - Moulboard - Front part / Etrave

LINKS / LEFT / GAUCHE RECHTS / RIGHT / DROITE

CKO 000 93

CKO 000 92

073231

073230

| | |
|-------------|---------------------|
| Unit weight | 1,82 |
| color | rot |
| piece unit | 500 Pal |
| accessories | 3 x C-1235, 523997V |



Verschleißstück - Streichblech - Vorderteil

7 - 8

Wearing part - Moulboard - Front part / Etrave

LINKS / LEFT / GAUCHE RECHTS / RIGHT / DROITE

CKO 000 63

CKO 000 62

073251

073250

| | |
|-------------|---------------------|
| Unit weight | 1,44 |
| color | rot |
| piece unit | 500 Pal |
| accessories | 2 x C-1235, 523997V |



Verschleißstück - Streichblech - Vorderteil

Wearing part - Moulboard - Front part / Etrave

LINKS / LEFT / GAUCHE RECHTS / RIGHT / DROITE

CKO 000 63V

CKO 000 62V

073251 10MM

073250 10MM

| | |
|-------------|---------------------|
| Unit weight | 1,80 |
| color | rot |
| piece unit | 500 Pal |
| accessories | 2 x C-1235, 523997V |



Verschleißstück - Streichblech - Vorderteil

6, 9

Wearing part - Moulboard - Front part / Etrave

LINKS / LEFT / GAUCHE RECHTS / RIGHT / DROITE

CKO 000 81

CKO 000 80

073257

073256

| | |
|-------------|---------------------|
| Unit weight | 1,58 |
| color | rot |
| piece unit | 500 Pal |
| accessories | 3 x C-1235, 523997V |



Teile passend zu
parts interchangeable
Pièces adaptables pour





Lemken

Anlage

Landside / Contre-Sep

CL1 000 70

340 1561

| | |
|---|--|
|  Unit weight | 3,70 |
|  color |  blau |
|  piece unit | 250 Pal |
|  accessories | 2 x B-1235 - 3015785, 5 |







Anlage

Landside / Contre-Sep

CL1 000 70

340 1570 A1VL

| | |
|---|---|
|  Unit weight | 3,70 |
|  color |  blau |
|  piece unit | 250 Pal |
|  accessories | 2 x B-1235 - 3015785, 5 |



Anlage

Landside / Contre-Sep

LINKS / LEFT / GAUCHE





CL1 002 21

341 100 03 Duramax

RECHTS / RIGHT / DROITE

CL1 002 20

341 100 02 Duramax

| | |
|---|--|
|  Unit weight | 6,80 |
|  color |  blau |
|  piece unit | 150 Pal |
|  accessories | |







Anlage

Landside / Contre-Sep

CL1 001 90

341 1460

| | |
|---|---|
|  Unit weight | 6,80 |
|  color |  blau |
|  piece unit | 150 Pal |
|  accessories | 4 x B-1235 - 3015785, 5 |







Anlage

Landside / Contre-Sep

CL1 001 37

341 1504 341 1500 A42

| | |
|---|--|
|  Unit weight | 4,60 |
|  color |  blau |
|  piece unit | 200 Pal |
|  accessories | 4 x B-1235 - 3015785, 5 |

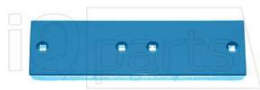





Anlage

Landside / Contre-Sep

CL1 000 89

341 1508 A36H

| | |
|---|---|
|  Unit weight | 5,90 |
|  color |  blau |
|  piece unit | 150 Pal |
|  accessories | 4 x B-1235 - 3015785, 5 |







Anlage

Landside / Contre-Sep

CL1 002 14

341 1525

| | |
|---|--|
|  Unit weight | 6,00 |
|  color |  blau |
|  piece unit | 150 Pal |
|  accessories | 1 x B-1235 - 3015785, 5 |







Anlage

Landside / Contre-Sep

CL1 000 53

341 1826 A1

| | |
|---|---|
|  Unit weight | 5,00 |
|  color |  blau |
|  piece unit | 200 Pal |
|  accessories | 4 x B-1235 - 3015785, 5 |

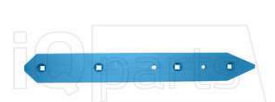

Teile passend zu
parts interchangeable
Pièces adaptables pour

Lemken

Anlage

Landside / Contre-Sep

LINKS / LEFT / GAUCHE





CL1 001 95

341 1871 WS2A

RECHTS / RIGHT / DROITE

CL1 001 94

341 1870 WS2A

| | |
|---|--|
|  Unit weight | 7,25 |
|  color |  blau |
|  piece unit | 150 Pal |
|  accessories | 2 x B-1235 - 3015785, 5 |



Anlagenkeil

Landside Tip / Nez de contre-sep

LINKS / LEFT / GAUCHE





CL1 001 27

340 1901 AK10

RECHTS / RIGHT / DROITE

CL1 001 26

340 1900 AK10

| | |
|---|---|
|  Unit weight | 1,05 |
|  color |  blau |
|  piece unit | 600 Pal |
|  accessories | 2 x B-1035 608D1035N |

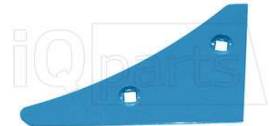





Anlagenkeil

Landside Tip / Nez de contre-sep

CL1 002 13

340 1903

| | |
|---|--|
|  Unit weight | 0,95 |
|  color |  blau |
|  piece unit | 600 Pal |
|  accessories | |







Anlagenschoner

Landside Protection / Protection de Contre-Sep

CL1 002 10

340 1490 SC18

| | |
|---|---|
|  Unit weight | 2,30 |
|  color |  blau |
|  piece unit | 400 Pal |
|  accessories | 2 x B-1235 - 3015785, 5 |



Anlagensech

Sword Landside / Ailerons Contre

LINKS / LEFT / GAUCHE





CL1 001 10

349 2891 L-AS2L

RECHTS / RIGHT / DROITE

CL1 001 09

349 2890 L-AS2R

| | |
|---|--|
|  Unit weight | 1,30 |
|  color |  blau |
|  piece unit | 500 Pal |
|  accessories | 2 x B-1035 608D1035N |



Aufschraubspitze

Reversible Point / Pointe Reversible

LINKS / LEFT / GAUCHE





CL1 000 88

336 5541 S2WL

RECHTS / RIGHT / DROITE

CL1 000 87

336 5540 S2WR

| | |
|---|---|
|  Unit weight | 2,25 |
|  color |  blau |
|  piece unit | 500 Pal |
|  accessories | 2 x B-1235 - 3015785, 5 |



Düngereinlegeblech

Skimmer Board / Versoirs de Rasette

LINKS / LEFT / GAUCHE





CL1 001 71

347 0601 M2L

RECHTS / RIGHT / DROITE

CL1 001 70

347 0600 M2R

| | |
|---|--|
|  Unit weight | 4,00 |
|  color |  blau |
|  piece unit | 250 Pal |
|  accessories | 2 x B-1035 608D1035N |



Düngereinlegeblech

Skimmer Board / Versoirs de Rasette

LINKS / LEFT / GAUCHE





CL1 001 86

347 0651

RECHTS / RIGHT / DROITE

CL1 001 85

347 0650

| | |
|---|---|
|  Unit weight | 1,70 |
|  color |  blau |
|  piece unit | 300 Pal |
|  accessories | 2 x B-1030, 547900V |



Teile passend zu
parts interchangeable
Pièces adaptables pour

Lemken

Düngereinlegeblech

Skimmer Board / Versoirs de Rasette

LINKS / LEFT / GAUCHE





CL1 001 93

347 0861

RECHTS / RIGHT / DROITE

CL1 001 92

347 0860

| | |
|---|--|
|  Unit weight | 3,10 |
|  color |  blau |
|  piece unit | 300 Pal |
|  accessories | 2 x B-1035 608D1035N |



Düngereinlegeschar

Skim Point / Soc de Rasette

LINKS / LEFT / GAUCHE





CL1 001 01D

3363711 Diamant

RECHTS / RIGHT / DROITE

CL1 001 00D

3363710 Diamant

| | |
|---|--|
|  Unit weight | |
|  color |  blau |
|  piece unit | 450 Pal |
|  accessories | 2 x B-1035 608D1035N |



Düngereinlegeschar

Skim Point / Soc de Rasette

LINKS / LEFT / GAUCHE





CL1 001 01

336 3711 S270

RECHTS / RIGHT / DROITE

CL1 001 00

336 3710 S270

| | |
|---|--|
|  Unit weight | 1,35 |
|  color |  blau |
|  piece unit | 500 Pal |
|  accessories | 2 x B-1035 608D1035N |



Düngereinlegeschar

Skim Point / Soc de Rasette

LINKS / LEFT / GAUCHE





CL1 001 01BV

336 3711V S270

RECHTS / RIGHT / DROITE

CL1 001 00BV

336710V S270

| | |
|---|--|
|  Unit weight | 1,70 |
|  color |  blau |
|  piece unit | 500 Pal |
|  accessories | 2 x B-1035 608D1035N |



Düngereinlegeschar

Skim Point / Soc de Rasette

LINKS / LEFT / GAUCHE





CL1 000 69

336 3713 S150

RECHTS / RIGHT / DROITE

CL1 000 68

336 3712 S150

| | |
|---|--|
|  Unit weight | 0,90 |
|  color |  blau |
|  piece unit | 700 Pal |
|  accessories | 2 x B-1035 608D1035N |



Düngereinlegeschar

Skim Point / Soc de Rasette

LINKS / LEFT / GAUCHE





CL1 000 72

336 3715 S185

RECHTS / RIGHT / DROITE

CL1 000 71

336 3714 S185

| | |
|---|--|
|  Unit weight | 1,05 |
|  color |  blau |
|  piece unit | 700 Pal |
|  accessories | 2 x B-1035 608D1035N |



Düngereinlegeschar

Skim Point / Soc de Rasette

LINKS / LEFT / GAUCHE





CL1 000 96

336 3721 S190

RECHTS / RIGHT / DROITE

CL1 000 95

336 3720 S190

| | |
|---|--|
|  Unit weight | 1,05 |
|  color |  blau |
|  piece unit | 700 Pal |
|  accessories | 2 x B-1035 608D1035N |







Düngereinlegeschar

Skim Point / Soc de Rasette

CL1 001 51

336 3724 S360

| | |
|---|--|
|  Unit weight | 1,50 |
|  color |  blau |
|  piece unit | 600 Pal |
|  accessories | 2 x B-1035 608D1035N |



Teile passend zu
parts interchangeable
Pièces adaptables pour

Lemken

Düngereinlegeschar

Skim Point / Soc de Rasette

LINKS / LEFT / GAUCHE





CL1 002 16

336 3729 S205L

RECHTS / RIGHT / DROITE

CL1 002 15

336 3728 S205R

| | |
|---|--|
|  Unit weight | 1,80 |
|  color |  blau |
|  piece unit | 500 Pal |
|  accessories | |



Mollblech -Streichblech

Mouldboard / Versoir

LINKS / LEFT / GAUCHE





CL1 001 21

344 1031

RECHTS / RIGHT / DROITE

CL1 001 20

344 1030

| | |
|---|---|
|  Unit weight | 14,70 |
|  color |  blau |
|  piece unit | 50 Pal |
|  accessories | 8 x B-1035 608D1035N |



B30

Mollblech -Streichblech

Mouldboard / Versoir

LINKS / LEFT / GAUCHE





CL1 001 23

344 1035

RECHTS / RIGHT / DROITE

CL1 001 22

344 1034

| | |
|---|--|
|  Unit weight | 15,50 |
|  color |  blau |
|  piece unit | 50 Pal |
|  accessories | 9 x B-1035 608D1035N |



B35

Mollblech -Streichblech

Mouldboard / Versoir

LINKS / LEFT / GAUCHE





CL1 001 25

344 1041

RECHTS / RIGHT / DROITE

CL1 001 24

344 1040

| | |
|---|---|
|  Unit weight | 17,80 |
|  color |  blau |
|  piece unit | 50 Pal |
|  accessories | 8 x B-1035 608D1035N |



B40

Scharblatt

Wing / Aileron

LINKS / LEFT / GAUCHE





CL1 000 92

335 1959 WG100BL 150x11

RECHTS / RIGHT / DROITE

CL1 000 91

335 1958 WG100B 150x11

| | |
|---|--|
|  Unit weight | 3,90 |
|  color |  blau |
|  piece unit | 200 Pal |
|  accessories | 3 x B-1235 - 3015785, 5 |



Scharblatt

Wing / Aileron

LINKS / LEFT / GAUCHE





CL1 000 76

335 2121 SB43D 150x11

RECHTS / RIGHT / DROITE

CL1 000 75

335 2120 SB43D 150x11

| | |
|---|---|
|  Unit weight | 4,05 |
|  color |  blau |
|  piece unit | 250 Pal |
|  accessories | 2 x B-1235 - 3015785, 5 |



Scharblatt

Wing / Aileron

LINKS / LEFT / GAUCHE





CL1 000 78

335 2131 SB45D 150x11

RECHTS / RIGHT / DROITE

CL0 000 77

190 3300

| | |
|---|--|
|  Unit weight | 4,70 |
|  color |  blau |
|  piece unit | 200 Pal |
|  accessories | 2 x B-1235 - 3015785, 5 |



Scharblatt

Wing / Aileron

LINKS / LEFT / GAUCHE





CL1 000 98

335 2135 SB56D 150x11

RECHTS / RIGHT / DROITE

CL1 000 97

335 2134 SB56D 150x11

| | |
|---|---|
|  Unit weight | 5,05 |
|  color |  blau |
|  piece unit | 200 Pal |
|  accessories | 3 x B-1235 - 3015785, 5 |



Teile passend zu
parts interchangeable
Pièces adaptables pour

Lemken

Scharblatt

Wing / Aileron

LINKS / LEFT / GAUCHE





CL1 000 76H

335 2221 150x11 hardface

RECHTS / RIGHT / DROITE

CL1 000 75H

335 2220 150x11 Hardface

| | |
|---|--|
|  Unit weight | 4,20 |
|  color |  blau |
|  piece unit | |
|  accessories | |



Scharblatt

Wing / Aileron

LINKS / LEFT / GAUCHE





CL1 000 78H

335 2231 SB45P Hardface

RECHTS / RIGHT / DROITE

CL1 000 77H

3352230 SB45P 150x11 Hardface

| | |
|---|---|
|  Unit weight | 4,90 |
|  color |  blau |
|  piece unit | 200 Pal |
|  accessories | 2 x B-1235 - 3015785, 5 |



Scharblatt

Wing / Aileron

LINKS / LEFT / GAUCHE





CL1 000 98H

335 2235 hardface

RECHTS / RIGHT / DROITE

CL1 000 97H

335 2234 150x11 hardface

| | |
|---|--|
|  Unit weight | 5,25 |
|  color |  blau |
|  piece unit | 200 Pal |
|  accessories | 3 x B-1235 - 3015785, 5 |



Schare

Share / Soc

LINKS / LEFT / GAUCHE





CL1 000 44

333 3803 NS2

RECHTS / RIGHT / DROITE

CL1 000 43

333 3802

| | |
|---|---|
|  Unit weight | 3,80 |
|  color |  blau |
|  piece unit | 150 Pal |
|  accessories | 3 x B-1235 - 3015785, 5 |



Schare

Share / Soc

LINKS / LEFT / GAUCHE





CL1 000 50

333 3813 M24S

RECHTS / RIGHT / DROITE

CL1 000 49

333 3812 M24S

| | |
|---|--|
|  Unit weight | 5,60 |
|  color |  blau |
|  piece unit | 150 Pal |
|  accessories | 3 x B-1235 - 3015785, 5 |



Scharspitze

Share point / Nez de Soc

LINKS / LEFT / GAUCHE





CL1 000 80

336 4051 B2S

RECHTS / RIGHT / DROITE

CL1 000 79

336 4050 B2S

| | |
|---|---|
|  Unit weight | 1,95 |
|  color |  blau |
|  piece unit | 400 Pal |
|  accessories | 2 x B-1235 - 3015785, 5 |



Scharspitze

Share point / Nez de Soc

LINKS / LEFT / GAUCHE





CL1 000 80H

336 4151 harface

RECHTS / RIGHT / DROITE

CL1 000 79H

336 4150 hardface

| | |
|---|--|
|  Unit weight | 2,00 |
|  color |  blau |
|  piece unit | 400 Pal |
|  accessories | 2 x B-1235 - 3015785, 5 |



Scharspitze

Share point / Nez de Soc

LINKS / LEFT / GAUCHE





CL1 000 80D

336 4251 B2SH DIAMANT

RECHTS / RIGHT / DROITE

CL1 000 79D

336 4250 B2SH DIAMANT

| | |
|---|---|
|  Unit weight | 3,54 |
|  color |  blau |
|  piece unit | 250 Pal |
|  accessories | 2 x B-1235 - 3015785, 5 |



Teile passend zu
parts interchangeable
Pièces adaptables pour

Lemken

Scharspitze





Share point / Nez de Soc

LINKS / LEFT / GAUCHE
CL1 000 80VH

3364155 HARDFACE C 2 SP

RECHTS / RIGHT / DROITE
CL1 000 79VH

3364154 hardface C 2 SP

| | |
|---|--|
|  Unit weight | 2,80 |
|  color |  blau |
|  piece unit | 400 Pal |
|  accessories | 2 x B-1235 - 3015785, 5 |



Scharspitze





Share point / Nez de Soc

LINKS / LEFT / GAUCHE
CL1 000 80DH

3364251DH B2 Diamant/Hardfac

RECHTS / RIGHT / DROITE
CL1 000 79DH

3364250 DH B2 Diamant/Hardfac

| | |
|---|---|
|  Unit weight | 3,65 |
|  color |  blau |
|  piece unit | 250 Pal |
|  accessories | 2 x B-1235 - 3015785, 5 |

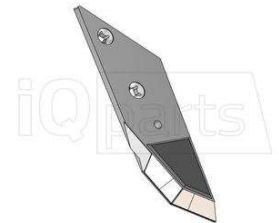

Streichschiene





Tailpress / Rallonge de Versoir

LINKS / LEFT / GAUCHE
CL1 001 57

347 6001 ST4

RECHTS / RIGHT / DROITE
CL1 001 56

347 6000 ST4

| | |
|---|--|
|  Unit weight | 1,30 |
|  color |  blau |
|  piece unit | 700 Pal |
|  accessories | |



Streifen

Strips for slated body / lame pour clair Voie





BS 40/42 Nr.1

LINKS / LEFT / GAUCHE
CL1 001 61

344 4011

RECHTS / RIGHT / DROITE
CL1 001 60

344 4010

| | |
|---|---|
|  Unit weight | 3,00 |
|  color |  blau |
|  piece unit | 300 Pal |
|  accessories | 4 x B-1035 608D1035N |



Streifen

Strips for slated body / lame pour clair Voie





BS 40 Nr.1

LINKS / LEFT / GAUCHE
CL1 001 59

344 4013

RECHTS / RIGHT / DROITE
CL1 001 58

344 4012

| | |
|---|--|
|  Unit weight | 4,75 |
|  color |  blau |
|  piece unit | 200 Pal |
|  accessories | 2 x B-1035 608D1035N |



Streifen

Strips for slated body / lame pour clair Voie





BS 40/42 Nr.2

LINKS / LEFT / GAUCHE
CL1 001 63

344 4021

RECHTS / RIGHT / DROITE
CL1 001 62

344 4020

| | |
|---|---|
|  Unit weight | 3,00 |
|  color |  blau |
|  piece unit | 300 Pal |
|  accessories | 2 x B-1035 608D1035N |



Streifen

Strips for slated body / lame pour clair Voie





BS 40/42 Nr.3

LINKS / LEFT / GAUCHE
CL1 001 65

344 4031

RECHTS / RIGHT / DROITE
CL1 001 64

344 4030

| | |
|---|--|
|  Unit weight | 4,40 |
|  color |  blau |
|  piece unit | 200 Pal |
|  accessories | 2 x B-1035 608D1035N |

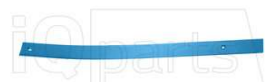

Streifen

Strips for slated body / lame pour clair Voie





BS 40 Nr.4

LINKS / LEFT / GAUCHE
CL1 001 67

344 4041

RECHTS / RIGHT / DROITE
CL1 001 66

344 4040

| | |
|---|---|
|  Unit weight | 4,40 |
|  color |  blau |
|  piece unit | 200 Pal |
|  accessories | 2 x B-1035 608D1035N |



Teile passend zu
parts interchangeable
Pièces adaptables pour

Lemken

Streifen **BS 42 Nr.4**

Strips for slated body / Lame pour clair Voie

| LINKS / LEFT / GAUCHE | RECHTS / RIGHT / DROITE |
|-------------------------------|-------------------------------|
| CL1 001 69 344 4043 | CL1 001 68 344 4042 |

| | |
|-------------|----------------------|
| Unit weight | 7,50 |
| color | blau |
| piece unit | 100 Pal |
| accessories | 3 x B-1035 608D1035N |



Streifen **US35/40**

Strips for slated body / Lame pour clair Voie

| LINKS / LEFT / GAUCHE | RECHTS / RIGHT / DROITE |
|------------------------------------|------------------------------------|
| CL1 001 80 344 4111 Nr.1 | CL1 001 79 344 4110 Nr.1 |

| | |
|-------------|----------------------|
| Unit weight | 4,20 |
| color | blau |
| piece unit | 200 Pal |
| accessories | 4 x B-1035 608D1035N |



Streifen **Nr.2 US35/40**

Strips for slated body / Lame pour clair Voie

| LINKS / LEFT / GAUCHE | RECHTS / RIGHT / DROITE |
|-------------------------------|-------------------------------|
| CL1 001 73 344 4121 | CL1 001 72 344 4120 |

| | |
|-------------|----------------------|
| Unit weight | 3,30 |
| color | blau |
| piece unit | 250 Pal |
| accessories | 2 x B-1035 608D1035N |



Streifen **Nr. 3 US35/40**

Strips for slated body / Lame pour clair Voie

| LINKS / LEFT / GAUCHE | RECHTS / RIGHT / DROITE |
|-------------------------------|-------------------------------|
| CL1 001 75 344 4131 | CL1 001 74 344 4130 |

| | |
|-------------|----------------------|
| Unit weight | 4,10 |
| color | blau |
| piece unit | 200 Pal |
| accessories | 2 x B-1035 608D1035N |



Streifen **US35**

Strips for slated body / Lame pour clair Voie

| LINKS / LEFT / GAUCHE | RECHTS / RIGHT / DROITE |
|------------------------------------|-------------------------------|
| CL1 001 82 344 4135 Nr.4 | CL1 001 81 344 4134 |

| | |
|-------------|----------------------|
| Unit weight | 4,20 |
| color | blau |
| piece unit | 250 Pal |
| accessories | 2 x B-1035 608D1035N |



Streifen **US40**

Strips for slated body / Lame pour clair Voie

| LINKS / LEFT / GAUCHE | RECHTS / RIGHT / DROITE |
|-------------------------------|-------------------------------|
| CL1 001 84 344 4141 | CL1 001 83 344 4140 |

| | |
|-------------|----------------------|
| Unit weight | 7,10 |
| color | blau |
| piece unit | 150 Pal |
| accessories | 4 x B-1035 608D1035N |



Verschleißstück - Streichblech - Vorderteil

Wearing part - Moulboard - Front part / Etrave

| LINKS / LEFT / GAUCHE | RECHTS / RIGHT / DROITE |
|------------------------------------|------------------------------------|
| CL1 001 05 345 0525 BU2K | CL1 001 04 345 0524 BU2K |

| | |
|-------------|----------------------|
| Unit weight | 2,00 |
| color | blau |
| piece unit | 500 Pal |
| accessories | 4 x B-1035 608D1035N |



Verschleißstück - Streichblech - Vorderteil

Wearing part - Moulboard - Front part / Etrave

| LINKS / LEFT / GAUCHE | RECHTS / RIGHT / DROITE |
|-----------------------------------|-----------------------------------|
| CL1 001 03 345 1001 B2K | CL1 001 02 345 1000 B2K |

| | |
|-------------|----------------------|
| Unit weight | 2,40 |
| color | blau |
| piece unit | 400 Pal |
| accessories | 3 x B-1035 608D1035N |

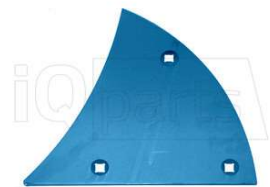

Teile passend zu
parts interchangeable
Pièces adaptables pour

Lemken

Verschleißstück - Streichblech - Vorderteil

Wearing part - Moulboard - Front part / Etrave

LINKS / LEFT / GAUCHE

CL1 001 03V

345 1003 B2KD 10mm

RECHTS / RIGHT / DROITE

CL1 001 02V

345 1002 B2KD 10mm

| | |
|-------------|----------------------|
| Unit weight | 3,02 |
| color | blau |
| piece unit | 300 Pal |
| accessories | 3 x B-1035 608D1035N |

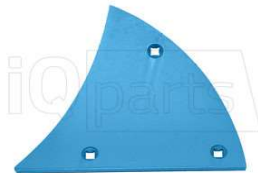

Verschleißstück - Streichblech - Vorderteil

Wearing part - Moulboard - Front part / Etrave

LINKS / LEFT / GAUCHE

CL1 001 12

345 1005 C2K

RECHTS / RIGHT / DROITE

CL1 001 11

345 1004 C2K

| | |
|-------------|----------------------|
| Unit weight | 2,15 |
| color | blau |
| piece unit | 400 Pal |
| accessories | 3 x B-1035 608D1035N |

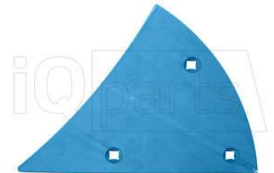

Verschleißstück - Streichblech - Vorderteil

Wearing part - Moulboard - Front part / Etrave

LINKS / LEFT / GAUCHE

CL1 001 12V

345 1005 C2K 10MM

RECHTS / RIGHT / DROITE

CL1 001 11V

345 1004 C2K 10MM

| | |
|-------------|----------------------|
| Unit weight | 2,67 |
| color | blau |
| piece unit | 300 Pal |
| accessories | 3 x B-1035 608D1035N |

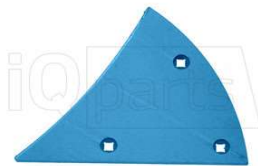

Verschleißstück - Streichblech - Vorderteil

Wearing part - Moulboard - Front part / Etrave

LINKS / LEFT / GAUCHE

CL1 000 85

3451011 B2KHL

RECHTS / RIGHT / DROITE

CL1 000 84

3451010 B2KH

| | |
|-------------|----------------------|
| Unit weight | 2,45 |
| color | blau |
| piece unit | 400 Pal |
| accessories | 3 x B-1035 608D1035N |







Teile passend zu
parts interchangeable
Pièces adaptables pour

Maschio

Anlage
Landside / Contre-Sep

CM3 000 15

A5210 0012





| | |
|---|-------------------------|
|  Unit weight | 3,88 |
|  color | rot |
|  piece unit | 200 Pal |
|  accessories | 2 x B-1235 - 3015785, 5 |



Anlage
Landside / Contre-Sep

CM3 000 12

A5210 0032





| | |
|---|-------------------------|
|  Unit weight | 5,31 |
|  color | rot |
|  piece unit | 150 Pal |
|  accessories | 2 x B-1235 - 3015785, 5 |



Anlage
Landside / Contre-Sep

CM3 000 16

A5210 0440

| | |
|---|-------------------------|
|  Unit weight | 3,88 |
|  color | rot |
|  piece unit | 250 Pal |
|  accessories | 2 x B-1235 - 3015785, 5 |







Anlagensech
Sword Landside / Ailerons Coutre

LINKS / LEFT / GAUCHE

CM3 000 18

A5090 0041

| | |
|---|-------------------------|
|  Unit weight | 2,77 |
|  color | rot |
|  piece unit | 300 Pal |
|  accessories | 2 x B-1235 - 3015785, 5 |

RECHTS / RIGHT / DROITE

CM3 000 17

A5090 0051

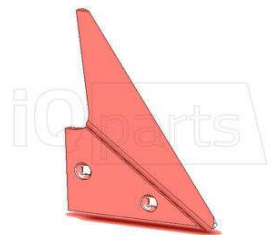





Anlagenspitze
Landside top / Pointe de Contre Sep

LINKS / LEFT / GAUCHE

CM3 000 14

A5034 1930

| | |
|---|-------------------------|
|  Unit weight | 0,00 |
|  color | rot |
|  piece unit | 500 Pal |
|  accessories | 2 x B-1235 - 3015785, 5 |

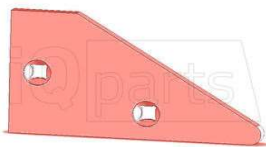

RECHTS / RIGHT / DROITE





CM3 000 13

A5034 1940

Gleitplatte
Sliding Plate / Talon

CM3 000 19

A5210 0510

| | |
|---|-------------------------|
|  Unit weight | 2,85 |
|  color | rot |
|  piece unit | 300 Pal |
|  accessories | 2 x B-1235 - 3015785, 5 |

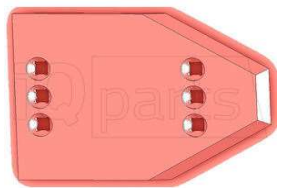





Meissel - Wechselspitze
Reversible Point / Pointe Reversible

LINKS / LEFT / GAUCHE

CM3 000 11

A5200 0020

| | |
|---|---------------------|
|  Unit weight | 1,57 |
|  color | rot |
|  piece unit | 500 Pal |
|  accessories | 2 x G-1240, 523732V |

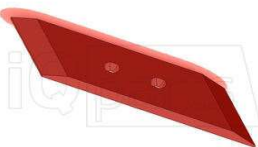

RECHTS / RIGHT / DROITE

CM3 000 10

A5200 0010

Teile passend zu
parts interchangeable
Pièces adaptables pour

Massey Ferguson

| | |
|---|---|
| Anlage Landside / Contre-Sep | XL |
| LINKS / LEFT / GAUCHE CP2 000 47 3940713M1 94605 | RECHTS / RIGHT / DROITE CP2 000 46 3940712M1 94604 |

| | |
|-------------|---------------------|
| Unit weight | 5,15 |
| color | rot |
| piece unit | 200 Pal |
| accessories | 1 x C-1235, 523997V |



| | |
|--|--|
| Anlagensech Sword Landside / Ailerons Coutre | |
| LINKS / LEFT / GAUCHE CP2 000 78 394 0745 | RECHTS / RIGHT / DROITE CP2 000 77 394 0746 |

| | |
|-------------|---------------------|
| Unit weight | 1,20 |
| color | rot |
| piece unit | 700 Pal |
| accessories | 2 x C-1235, 523997V |



| | |
|---|----------------------|
| Anlagensech Sword Landside / Ailerons Coutre | V; UC; FK; FC |
| RECHTS / RIGHT / DROITE CP2 000 61 3940476M1 86725 | |

| | |
|-------------|---------------------|
| Unit weight | 1,25 |
| color | rot |
| piece unit | 700 Pal |
| accessories | 2 x C-1235, 523997V |

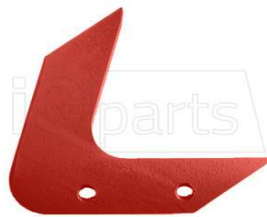

| | |
|--|--|
| Düngereinlegeblech Skimmer Board / Versoirs de Rasette | |
| LINKS / LEFT / GAUCHE CP2 000 82 3940502M1 91804 | RECHTS / RIGHT / DROITE CP2 000 81 91 803 |

| | |
|-------------|---------------------|
| Unit weight | 2,05 |
| color | rot |
| piece unit | 300 Pal |
| accessories | 2 x C-1235, 523997V |



| | |
|---|---|
| Düngereinlegeschar Skim Point / Soc de Rasette | |
| LINKS / LEFT / GAUCHE CP2 000 80 3940500M1 91802 | RECHTS / RIGHT / DROITE CP2 000 79 3940499M1 91801 |

| | |
|-------------|---------------------|
| Unit weight | 1,45 |
| color | rot |
| piece unit | 700 Pal |
| accessories | 2 x C-1235, 523997V |



| | |
|---|--|
| Gleitplatte Sliding Plate / Talon | |
| RECHTS / RIGHT / DROITE CP2 000 83 3940670M1 94289 | |

| | |
|-------------|---------------------|
| Unit weight | 2,80 |
| color | rot |
| piece unit | 300 Pal |
| accessories | 2 x C-1235, 523997V |



| | |
|---|--|
| Mollblech -Streichblech Mouldboard / Versoir | XL |
| LINKS / LEFT / GAUCHE CP2 000 40 3940743M1 94595 | RECHTS / RIGHT / DROITE CP2 000 39 94 594 |

| | |
|-------------|---------------------|
| Unit weight | 18,80 |
| color | rot |
| piece unit | 50 Pal |
| accessories | 8 x C-1235, 523997V |



| | |
|--|--|
| Scharblatt Wing / Aileron | |
| LINKS / LEFT / GAUCHE CP2 000 30 394 0334 | RECHTS / RIGHT / DROITE CP2 000 29 85 004 |

| | |
|-------------|---------------------|
| Unit weight | 3,00 |
| color | rot |
| piece unit | 200 Pal |
| accessories | 2 x C-1235, 523997V |



Teile passend zu
parts interchangeable
Pièces adaptables pour

Massey Ferguson

| Scharblatt Wing / Aileron | | V; FK |
|------------------------------|-------------------------|-------|
| LINKS / LEFT / GAUCHE | RECHTS / RIGHT / DROITE | |
| CP2 000 26 | CP2 000 25 | |
| 3940314M1 85381 14" | 85 383 14" | |

| | |
|-------------|--|
| Unit weight | 4,35 |
| color | ■ rot |
| piece unit | 200 Pal |
| accessories | 2 x C-1235, 523997V |



| Scharblatt Wing / Aileron | | V; FK |
|------------------------------|-------------------------|-------|
| LINKS / LEFT / GAUCHE | RECHTS / RIGHT / DROITE | |
| CP2 000 50 | CP2 000 49 | |
| 3940345M1 85382 16" | 85 384 16" | |

| | |
|-------------|--|
| Unit weight | 4,50 |
| color | ■ rot |
| piece unit | 200 Pal |
| accessories | 2 x C-1235, 523997V |



| Scharblatt Wing / Aileron | | AX |
|------------------------------|-------------------------|----|
| LINKS / LEFT / GAUCHE | RECHTS / RIGHT / DROITE | |
| CP2 000 52 | CP2 000 51 | |
| 3940707M1 94599 14" | 94 598 14" | |

| | |
|-------------|--|
| Unit weight | 3,60 |
| color | ■ rot |
| piece unit | 200 Pal |
| accessories | 2 x C-1235, 523997V |



| Scharblatt Wing / Aileron | | AX |
|------------------------------|-------------------------|----|
| LINKS / LEFT / GAUCHE | RECHTS / RIGHT / DROITE | |
| CP2 000 54 | CP2 000 53 | |
| 3940709M1 94601 16" | 94 600 16" | |

| | |
|-------------|--|
| Unit weight | 4,05 |
| color | ■ rot |
| piece unit | 200 Pal |
| accessories | 2 x C-1235, 523997V |



| Verschleißstück - Streichblech - Vorderteil Wearing part - Moulboard - Front part / Etrave | | AX |
|---|-------------------------|----|
| LINKS / LEFT / GAUCHE | RECHTS / RIGHT / DROITE | |
| CP2 000 38 | CP2 000 37 | |
| 3940705M1 94597 | 94 596 | |

| | |
|-------------|--|
| Unit weight | 1,35 |
| color | ■ rot |
| piece unit | 500 Pal |
| accessories | 2 x C-1235, 523997V |

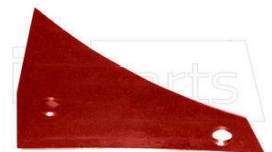

Teile passend zu
parts interchangeable
Pièces adaptables pour





Naud

Anlage

Landside / Contre-Sep

CNO 000 27

030 65101 D/G

| | |
|---|--|
|  Unit weight | 4,55 |
|  color | ■ rot |
|  piece unit | 200 Pal |
|  accessories | 4 x E-1430, 546601V |







Anlage

Landside / Contre-Sep

CNO 000 28

030 65201 D/G

| | |
|---|--|
|  Unit weight | 2,90 |
|  color | ■ rot |
|  piece unit | 350 Pal |
|  accessories | 2 x E-1430, 546601V |







Anlage

Landside / Contre-Sep

CNO 000 14

030 65501D/G 031 1910

| | |
|---|--|
|  Unit weight | 3,65 |
|  color | ■ rot |
|  piece unit | 250 Pal |
|  accessories | 3 x E-1430, 546601V |







Düngereinlegeblech

Skimmer Board / Versoirs de Rasette

LINKS / LEFT / GAUCHE

CNO 000 52

04023103G 400421G

| | |
|---|--|
|  Unit weight | 2,60 |
|  color | ■ rot |
|  piece unit | Pal |
|  accessories | 2 x D-1030, 523742V |

RECHTS / RIGHT / DROITE

CNO 000 51

04023103D 400421D







Düngereinlegeschar

Skim Point / Soc de Rasette

LINKS / LEFT / GAUCHE

CNO 000 17

040 32101G 031 240G

| | |
|---|--|
|  Unit weight | 0,95 |
|  color | ■ rot |
|  piece unit | 1 000 Pal |
|  accessories | 2 x D-1030, 523742V |



RECHTS / RIGHT / DROITE

CNO 000 16

040 32101D 031 240D





Düngereinlegeschar

Skim Point / Soc de Rasette

LINKS / LEFT / GAUCHE

CNO 000 31

040 32104G 031 241G

| | |
|---|--|
|  Unit weight | 1,20 |
|  color | ■ rot |
|  piece unit | 500 Pal |
|  accessories | 2 x D-1030, 523742V |



RECHTS / RIGHT / DROITE

CNO 000 30

040 32104D 031 241D





Meissel - Wechselpitze

Reversible Point / Pointe Reversible

LINKS / LEFT / GAUCHE

CNO 000 13

03054502G 03054202G 031235G

| | |
|---|--|
|  Unit weight | 2,15 |
|  color | ■ rot |
|  piece unit | 500 Pal |
|  accessories | 2 x E-1440, 546602V |



RECHTS / RIGHT / DROITE

CNO 000 12

03054502D 03054202D 031235D





Schare

Share / Soc

LINKS / LEFT / GAUCHE

CNO 031 00

03055204G 03055254G 400111G

| | |
|---|--|
|  Unit weight | 7,00 |
|  color | ■ rot |
|  piece unit | 150 Pal |
|  accessories | 4 x E-1430, 546601V |



RECHTS / RIGHT / DROITE

CNO 030 00

030 55204 D

Teile passend zu
parts interchangeable
Pièces adaptables pour

Naud

Schare - Wechselspitzenschare

Share for rev. Point / Soc pour pointe reversilbe

LINKS / LEFT / GAUCHE

CNO 011 00

03054154G 03054452G 031189G

RECHTS / RIGHT / DROITE

CNO 010 00

03054154D 03054452D 031189D

| | |
|---------------|---------------------|
| Unit weight | 6,80 |
| color | rot |
| piece unit | 100 Pal |
| accessories | 4 x E-1430, 546601V |



Schare - Wechselspitzenschare

Share for rev. Point / Soc pour pointe reversilbe

LINKS / LEFT / GAUCHE

CNO 011 00

03055152G 03054152G

RECHTS / RIGHT / DROITE

CNO 010 00

03055152D 03054152D

| | |
|---------------|---------------------|
| Unit weight | 6,80 |
| color | rot |
| piece unit | 100 Pal |
| accessories | 4 x E-1430, 546601V |



Scharsech

Coulter Knife / Coutre Incorporé

LINKS / LEFT / GAUCHE

CNO 000 11

030 60101G

RECHTS / RIGHT / DROITE

CNO 000 10

030 60101D

| | |
|---------------|---------------|
| Unit weight | 0,75 |
| color | sandgestrahlt |
| piece unit | |
| accessories | |

Teile passend zu
parts interchangeable
Pièces adaptables pour

Niemeyer

| | |
|--|-------------------------|
| Anlage Landside / Contre-Sep | |
| LINKS / LEFT / GAUCHE | RECHTS / RIGHT / DROITE |
| NIO 206 19 | NIO 206 20 |
| 020619 | 020620 N 15 G 1 |

| | |
|-------------|---|
| Unit weight | 4,00 |
| color | rot |
| piece unit | 250 Pal |
| accessories | 1 x A-1650-M16 x 50 mit st 1 x M-1240 M12x40, 5C |



| | |
|--|-------------------------|
| Anlage Landside / Contre-Sep | |
| LINKS / LEFT / GAUCHE | RECHTS / RIGHT / DROITE |
| NIO 206 27 | NIO 206 28 |
| 020627 N15G | 020628 N15G |

| | |
|-------------|---|
| Unit weight | 5,00 |
| color | rot |
| piece unit | 200 Pal |
| accessories | 1 x A-1650-M16 x 50 mit st 1 x M-1240 M12x40, 5C |



| | |
|--|---------------|
| Anlage Landside / Contre-Sep | WST430 |
| NIO 240 72 | |
| 024072 N15G | |

| | |
|-------------|---|
| Unit weight | 5,05 |
| color | rot |
| piece unit | 200 Pal |
| accessories | 1 x A-1650-M16 x 50 mit st 1 x M-1240 M12x40, 5C |



| | |
|--|--|
| Anlagenkeil Landside Tip / Nez de contre-sep | |
| NIO 240 04 | |
| 024004 N15G | |

| | |
|-------------|-----------------------|
| Unit weight | 1,00 |
| color | rot |
| piece unit | 1 000 Pal |
| accessories | 2 x M-1240 M12x40, 5C |



| | |
|--|--|
| Anlagenkeil Landside Tip / Nez de contre-sep | |
| NIO 240 13 | |
| 024013 | |

| | |
|-------------|-----------------------|
| Unit weight | 1,63 |
| color | rot |
| piece unit | 700 Pal |
| accessories | 2 x M-1240 M12x40, 5C |



| | |
|---|-------------------------|
| Anlagensech Sword Landside / Ailerons Coultre | WST430 |
| LINKS / LEFT / GAUCHE | RECHTS / RIGHT / DROITE |
| NIO 262 41 | NIO 262 40 |
| 026241 | 026240 |

| | |
|-------------|-----------------------|
| Unit weight | 1,90 |
| color | rot |
| piece unit | 200 Pal |
| accessories | 2 x M-1240 M12x40, 5C |



| | |
|---|-------------------------|
| Anlagensech Sword Landside / Ailerons Coultre | |
| LINKS / LEFT / GAUCHE | RECHTS / RIGHT / DROITE |
| NIO 262 43 | NIO 262 42 |
| 026243 | 026242 |

| | |
|-------------|-----------------------|
| Unit weight | 2,15 |
| color | rot |
| piece unit | 200 Pal |
| accessories | 2 x M-1240 M12x40, 5C |



| | |
|--|-------------------------|
| Düngereinlegeblech Skimmer Board / Versoirs de Rasette | |
| LINKS / LEFT / GAUCHE | RECHTS / RIGHT / DROITE |
| NIO 262 73 | NIO 262 74 |
| 026273 | 026274 |

| | |
|-------------|---------|
| Unit weight | 2,20 |
| color | rot |
| piece unit | 300 Pal |
| accessories | |



Teile passend zu
parts interchangeable
Pièces adaptables pour

Niemeyer

Düngereinlegeschar

Skim Point / Soc de Rasette

LINKS / LEFT / GAUCHE





NIO 260 17

026017

RECHTS / RIGHT / DROITE

NIO 260 18

026018

| | |
|---|--|
|  Unit weight | 1,10 |
|  color | ■ rot |
|  piece unit | 900 Pal |
|  accessories | 2 x D-1030, 523742V |



Düngereinlegeschar

Skim Point / Soc de Rasette

LINKS / LEFT / GAUCHE





CN1 000 14

026087 3AL CN100028

RECHTS / RIGHT / DROITE

CN1 000 13

026088 3AR CN100027

| | |
|---|--|
|  Unit weight | 1,00 |
|  color | ■ rot |
|  piece unit | 1 000 Pal |
|  accessories | 2 x D-1030, 523742V |



Düngereinlegeschar

Skim Point / Soc de Rasette

LINKS / LEFT / GAUCHE





NIO 261 03

NIO26103

RECHTS / RIGHT / DROITE

NIO 261 04

026104

| | |
|---|--|
|  Unit weight | 1,15 |
|  color | ■ rot |
|  piece unit | 1 000 Pal |
|  accessories | 2 x D-1030, 523742V |







Gleitplatte

Sliding Plate / Talon

NIO 262 48

026248

| | |
|---|--|
|  Unit weight | 5,40 |
|  color | ■ rot |
|  piece unit | 200 Pal |
|  accessories | 2 x A-1650-M16 x 50 mit st |



Meissel - Wechselspitze

Reversible Point / Pointe Reversible

LINKS / LEFT / GAUCHE





NIO 241 05

024105 N15G

RECHTS / RIGHT / DROITE

NIO 241 04

024104 N15G

| | |
|---|--|
|  Unit weight | 1,28 |
|  color | ■ rot |
|  piece unit | 500 Pal |
|  accessories | 2 x O-1235 M12x35 Mu |



Mollblech - Streichblech

Mouldboard / Versoir

LINKS / LEFT / GAUCHE





CN1 000 42

020737 N15G-753

RECHTS / RIGHT / DROITE

CN1 000 41

N15G-754

| | |
|---|--|
|  Unit weight | 9,60 |
|  color | ■ rot |
|  piece unit | 50 Pal |
|  accessories | 6 x D-1235 11014D123 |



Scharblatt

Wing / Aileron

LINKS / LEFT / GAUCHE





NIO 241 03

024103 SH15G

RECHTS / RIGHT / DROITE

NIO 241 02

024102 SH15G

| | |
|---|--|
|  Unit weight | 4,05 |
|  color | ■ rot |
|  piece unit | 200 Pal |
|  accessories | 2 x D-1235 11014D123 |



Scharblatt

Wing / Aileron

LINKS / LEFT / GAUCHE





NIO 241 07

024107 SH15G

RECHTS / RIGHT / DROITE

NIO 241 06

024106 SH15G

| | |
|---|--|
|  Unit weight | 4,40 |
|  color | ■ rot |
|  piece unit | 200 Pal |
|  accessories | 2 x D-1235 11014D123 |



Teile passend zu
parts interchangeable
Pièces adaptables pour

Niemeyer

Scharblatt WST430

| | |
|-----------------------|-------------------------|
| LINKS / LEFT / GAUCHE | RECHTS / RIGHT / DROITE |
| NIO 241 21 | NIO 241 22 |
| 024121 NH6G | 024122 NH6G |

| | |
|-------------|--|
| Unit weight | 4,60 |
| color | ■ rot |
| piece unit | 200 Pal |
| accessories | 3 x D-1235 11014D123 |



Schare WST430

| | |
|-----------------------|-------------------------|
| LINKS / LEFT / GAUCHE | RECHTS / RIGHT / DROITE |
| CN1 000 46 | CN1 000 45 |
| N 152 200615 | N 152 200614 |

| | |
|-------------|--|
| Unit weight | 4,90 |
| color | ■ rot |
| piece unit | 150 Pal |
| accessories | 3 x D-1235 11014D123 |



Schare WST430

| | |
|-----------------------|-------------------------|
| LINKS / LEFT / GAUCHE | RECHTS / RIGHT / DROITE |
| CN1 000 50 | CN1 000 49 |
| N 172 200815 | N 172 200814 |

| | |
|-------------|--|
| Unit weight | 5,35 |
| color | ■ rot |
| piece unit | 150 Pal |
| accessories | 4 x D-1235 11014D123 |



Schare WST430

| | |
|-----------------------|-------------------------|
| LINKS / LEFT / GAUCHE | RECHTS / RIGHT / DROITE |
| CN1 056 00 | CN1 055 00 |
| WST 430 L NI | WST 430 NI |

| | |
|-------------|--|
| Unit weight | 6,60 |
| color | ■ rot |
| piece unit | 150 Pal |
| accessories | 5 x D-1235 11014D123 |

Schare - Wechselspitzenschare WST430

| | |
|-----------------------|-------------------------|
| LINKS / LEFT / GAUCHE | RECHTS / RIGHT / DROITE |
| NI2 006 17 | NI2 006 16 |
| 200617 N15 G-3-Loch | 200616 N15 G - 3-Loch |

| | |
|-------------|--|
| Unit weight | 5,00 |
| color | ■ rot |
| piece unit | 150 Pal |
| accessories | 3 x D-1235 11014D123 |



Schare - Wechselspitzenschare WST430

| | |
|-------------------------|--|
| RECHTS / RIGHT / DROITE | |
| NI2 008 30 | |
| 200830 N17 G | |

| | |
|-------------|--|
| Unit weight | 5,25 |
| color | ■ rot |
| piece unit | 200 Pal |
| accessories | 4 x D-1235 11014D123 |



Schare - Wechselspitzenschare WST430

| | |
|-----------------------|-------------------------|
| LINKS / LEFT / GAUCHE | RECHTS / RIGHT / DROITE |
| CN1 000 56 | CN1 000 55 |
| WST 430 L NI | WST 430 NI |

| | |
|-------------|--|
| Unit weight | 6,30 |
| color | ■ rot |
| piece unit | 150 Pal |
| accessories | 5 x D-1235 11014D123 |



Scharspitze WST430

| | |
|-----------------------|-------------------------|
| LINKS / LEFT / GAUCHE | RECHTS / RIGHT / DROITE |
| NI2 006 79 | NI2 006 78 |
| 200679 SH15G | 200678 SH15G |

| | |
|-------------|--|
| Unit weight | 2,30 |
| color | ■ rot |
| piece unit | 400 Pal |
| accessories | 3 x D-1235 11014D123 |



Teile passend zu
parts interchangeable
Pièces adaptables pour

Niemeyer

Scharspitze

Share point / Nez de Soc

LINKS / LEFT / GAUCHE





NIO 241 39

200679 SH15G hardface

RECHTS / RIGHT / DROITE

NIO 241 40

200678 SH15G hardface

| | |
|---|---|
|  Unit weight | 2,40 |
|  color |  rot |
|  piece unit | 400 Pal |
|  accessories | 2 x D-1235 11014D123 |



Streifen

Strips for slated body / Lame pour clair Voie

WST 430

LINKS / LEFT / GAUCHE





NIO 241 25

024125 II

RECHTS / RIGHT / DROITE

NIO 241 26

024126 II

| | |
|---|--|
|  Unit weight | 4,40 |
|  color |  rot |
|  piece unit | 200 Pal |
|  accessories | 4 x M-1240 M12x40, 50 |



Streifen

Strips for slated body / Lame pour clair Voie

WST 430

LINKS / LEFT / GAUCHE





NIO 241 27

024127 III

RECHTS / RIGHT / DROITE

NIO 241 28

024128 III

| | |
|---|---|
|  Unit weight | 3,00 |
|  color |  rot |
|  piece unit | 300 Pal |
|  accessories | |



Streifen

Strips for slated body / Lame pour clair Voie

WST 430

LINKS / LEFT / GAUCHE





NIO 241 29

024129 I

RECHTS / RIGHT / DROITE

NIO 241 30

024130 I

| | |
|---|--|
|  Unit weight | 8,20 |
|  color |  rot |
|  piece unit | 100 Pal |
|  accessories | 1 x M-1240 M12x40, 50 |



Streifen

Strips for slated body / Lame pour clair Voie

WST 430

LINKS / LEFT / GAUCHE





NIO 241 31

024131 IV

RECHTS / RIGHT / DROITE

NIO 241 32

024132 IV

| | |
|---|---|
|  Unit weight | 3,50 |
|  color |  rot |
|  piece unit | 300 Pal |
|  accessories | 2 x M-1240 M12x40, 50 |



Streifen

Strips for slated body / Lame pour clair Voie

LINKS / LEFT / GAUCHE





PR9 002 03P

NIO 241 27

RECHTS / RIGHT / DROITE

PR9 001 03P

NIO 241 28

| | |
|---|--|
|  Unit weight | 3,00 |
|  color |  rot |
|  piece unit | 300 Pal |
|  accessories | 2 x D-1235 11014D123 |



Verschleißstück - Streichblech - Vorderteil

Wearing part - Moulboard - Front part / Etrave

LINKS / LEFT / GAUCHE





NIO 240 81

024081

RECHTS / RIGHT / DROITE

NIO 240 80

024080

| | |
|---|---|
|  Unit weight | 2,75 |
|  color |  rot |
|  piece unit | 400 Pal |
|  accessories | 3 x M-1240 M12x40, 50 |



Verschleißstück - Streichblech - Vorderteil

Wearing part - Moulboard - Front part / Etrave

LINKS / LEFT / GAUCHE





NIO 240 81L26

024081L26

RECHTS / RIGHT / DROITE

NIO 240 80L26

024080L26

| | |
|---|--|
|  Unit weight | 2,42 |
|  color |  rot |
|  piece unit | 400 Pal |
|  accessories | 3 x M-1235 PR900002 P |



Teile passend zu
parts interchangeable
Pièces adaptables pour

Niemeyer

Verschleißstück - Streichblech - Vorderteil
Wearing part - Moulboard - Front part / Etrave

LINKS / LEFT / GAUCHE





N12 007 45

200745

RECHTS / RIGHT / DROITE

N12 007 46

200746

| | |
|---|---|
|  Unit weight | 2,55 |
|  color |  rot |
|  piece unit | 400 Pal |
|  accessories | |



Teile passend zu
parts interchangeable
Pièces adaptables pour

Överum

| | |
|--|-----------|
| Anlage Landside / Contre-Sep | SR |
| RECHTS / RIGHT / DROITE | |
| CP2 000 06 | |
| 74 602 | |

| | |
|-------------|---------|
| Unit weight | 1,95 |
| color | rot |
| piece unit | 500 Pal |
| accessories | |



| | |
|--|-----------|
| Anlage Landside / Contre-Sep | SR |
| RECHTS / RIGHT / DROITE | |
| CP2 000 07 | |
| 74 612 | |

| | |
|-------------|---------|
| Unit weight | 1,75 |
| color | rot |
| piece unit | 500 Pal |
| accessories | |



| | |
|--|-----------|
| Anlage Landside / Contre-Sep | SR |
| RECHTS / RIGHT / DROITE | |
| CP2 000 42 | |
| 80 603 | |

| | |
|-------------|---------|
| Unit weight | 5,88 |
| color | rot |
| piece unit | 200 Pal |
| accessories | |



| | |
|--|-------------------------|
| Anlage Landside / Contre-Sep | UC; FC |
| LINKS / LEFT / GAUCHE | RECHTS / RIGHT / DROITE |
| CP2 000 28 | CP2 000 27 |
| 85 196 | 83 981 |

| | |
|-------------|---------------------|
| Unit weight | 3,90 |
| color | rot |
| piece unit | 250 Pal |
| accessories | 1 x C-1235, 523997V |



| | |
|--|-------------------------|
| Anlage Landside / Contre-Sep | UC |
| LINKS / LEFT / GAUCHE | RECHTS / RIGHT / DROITE |
| CP2 000 45 | CP2 000 44 |
| 85 197 / 94 287 | 85 118 / 94 286 |

| | |
|-------------|---------------------|
| Unit weight | 4,75 |
| color | rot |
| piece unit | 200 Pal |
| accessories | 1 x C-1235, 523997V |



| | |
|--|-------------------------|
| Anlage Landside / Contre-Sep | AX |
| LINKS / LEFT / GAUCHE | RECHTS / RIGHT / DROITE |
| CP2 000 47 | CP2 000 46 |
| 94 605 | 3940712M1 94604 |

| | |
|-------------|---------------------|
| Unit weight | 5,15 |
| color | rot |
| piece unit | 200 Pal |
| accessories | 1 x C-1235, 523997V |



| | |
|--|-------------------------|
| Anlage Landside / Contre-Sep | |
| LINKS / LEFT / GAUCHE | RECHTS / RIGHT / DROITE |
| CP2 001 11 | CP2 001 10 |
| 94 607 | 94 606 |

| | |
|-------------|---------|
| Unit weight | 5,20 |
| color | schwarz |
| piece unit | |
| accessories | |



| | |
|--|-------------------------|
| Anlage Landside / Contre-Sep | |
| LINKS / LEFT / GAUCHE | RECHTS / RIGHT / DROITE |
| CP2 000 95 | CP2 000 94 |
| 96 095 | 96 094 |

| | |
|-------------|---------------------|
| Unit weight | 5,35 |
| color | rot |
| piece unit | 200 Pal |
| accessories | 2 x C-1235, 523997V |



Teile passend zu
parts interchangeable
Pièces adaptables pour

Överum

Anlagensech





Sword Landside / Ailerons Coutre

V; UC; FK; FC

RECHTS / RIGHT / DROITE

CP2 000 61

86 725

| | |
|---|--|
|  Unit weight | 1,25 |
|  color | ■ rot |
|  piece unit | 700 Pal |
|  accessories | 2 x C-1235, 523997V |

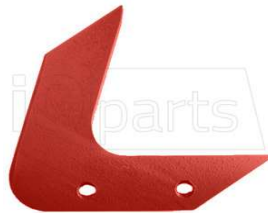





Anlagensech

Sword Landside / Ailerons Coutre

LINKS / LEFT / GAUCHE

CP2 000 78

94 623 (86877)

| | |
|---|--|
|  Unit weight | 1,20 |
|  color | ■ rot |
|  piece unit | 700 Pal |
|  accessories | 2 x C-1235, 523997V |

RECHTS / RIGHT / DROITE

CP2 000 77

394 0746







Düngereinlegeblech

Skimmer Board / Versoirs de Rasette

LINKS / LEFT / GAUCHE

CP2 000 82

91 804

| | |
|---|--|
|  Unit weight | 2,05 |
|  color | ■ rot |
|  piece unit | 300 Pal |
|  accessories | 2 x C-1235, 523997V |



RECHTS / RIGHT / DROITE

CP2 000 81

91 803





Düngereinlegeblech

Skimmer Board / Versoirs de Rasette

LINKS / LEFT / GAUCHE

CP2 000 97

96 065

| | |
|---|--|
|  Unit weight | 3,90 |
|  color | ■ blau |
|  piece unit | 300 Pal |
|  accessories | 2 x C-1235, 523997V |



RECHTS / RIGHT / DROITE

CP2 000 96

96 064

Düngereinlegeschar





Skim Point / Soc de Rasette

FK

LINKS / LEFT / GAUCHE

CP2 000 80

91 802

| | |
|---|--|
|  Unit weight | 1,45 |
|  color | ■ rot |
|  piece unit | 700 Pal |
|  accessories | 2 x C-1235, 523997V |



RECHTS / RIGHT / DROITE

CP2 000 79

3940499M1 91801

Gleitplatte





Sliding Plate / Talon

AX

RECHTS / RIGHT / DROITE

CP2 000 83

94 289

| | |
|---|--|
|  Unit weight | 2,80 |
|  color | ■ rot |
|  piece unit | 300 Pal |
|  accessories | 2 x C-1235, 523997V |



Meissel - Wechselspitze

Reversible Point / Pointe Reversible

V

LINKS / LEFT / GAUCHE





CP2 000 24

85143 92207

RECHTS / RIGHT / DROITE

CP2 000 23

84060 92206

| | |
|---|--|
|  Unit weight | 2,34 |
|  color | ■ rot |
|  piece unit | 500 Pal |
|  accessories | 2 x C-1235, 523997V |



Meissel - Wechselspitze

Reversible Point / Pointe Reversible

XL

LINKS / LEFT / GAUCHE





CP2 000 34

94 609

RECHTS / RIGHT / DROITE

CP2 000 33

94 608

| | |
|---|--|
|  Unit weight | 2,25 |
|  color | ■ rot |
|  piece unit | 500 Pal |
|  accessories | 2 x C-1235, 523997V |



Teile passend zu
parts interchangeable
Pièces adaptables pour

Överum





Mollblech -Streichblech

Mouldboard / Versoir

LINKS / LEFT / GAUCHE

CP2 000 91

84 087

| | |
|---|--|
|  Unit weight | 13,35 |
|  color | ■ rot |
|  piece unit | 50 Pal |
|  accessories | 5 x C-1235, 523997V |



Mollblech -Streichblech





Mouldboard / Versoir

XL

LINKS / LEFT / GAUCHE

CP2 000 40

94 595

| | |
|---|--|
|  Unit weight | 18,80 |
|  color | ■ rot |
|  piece unit | 50 Pal |
|  accessories | 8 x C-1235, 523997V |

RECHTS / RIGHT / DROITE

CP2 000 39

94 594







Schar - Vorderteil

Wing - Front part / Aileron devant

LINKS / LEFT / GAUCHE

CP2 001 15

85206

| | |
|---|--|
|  Unit weight | 1,80 |
|  color | ■ rot |
|  piece unit | 400 Pal |
|  accessories | 2 x C-1235, 523997V |



RECHTS / RIGHT / DROITE

CP2 001 14

84 987





Schar - Vorderteil

Wing - Front part / Aileron devant

LINKS / LEFT / GAUCHE

CP2 000 93

94 611

| | |
|---|--|
|  Unit weight | 2,06 |
|  color | ■ rot |
|  piece unit | 450 Pal |
|  accessories | 2 x C-1235, 523997V |



RECHTS / RIGHT / DROITE

CP2 000 92

94 610





Schar - Vorderteil

Wing - Front part / Aileron devant

LINKS / LEFT / GAUCHE

CP2 000 87

94 613

| | |
|---|--|
|  Unit weight | 1,50 |
|  color | ■ rot |
|  piece unit | 500 Pal |
|  accessories | 2 x C-1235, 523997V |



RECHTS / RIGHT / DROITE

CP2 000 86

94 612

Scharblatt





Wing / Aileron

UC; FC

LINKS / LEFT / GAUCHE

CP2 000 30

85 194

| | |
|---|--|
|  Unit weight | 3,00 |
|  color | ■ rot |
|  piece unit | 200 Pal |
|  accessories | 2 x C-1235, 523997V |



RECHTS / RIGHT / DROITE

CP2 000 29

85 004

14"

14"

Scharblatt





Wing / Aileron

V; FK

LINKS / LEFT / GAUCHE

CP2 000 26

85 381

| | |
|---|--|
|  Unit weight | 4,35 |
|  color | ■ rot |
|  piece unit | 200 Pal |
|  accessories | 2 x C-1235, 523997V |



RECHTS / RIGHT / DROITE

CP2 000 25

85 383

14"

Scharblatt





Wing / Aileron

V; FK

LINKS / LEFT / GAUCHE

CP2 000 50

85 382

| | |
|---|--|
|  Unit weight | 4,50 |
|  color | ■ rot |
|  piece unit | 200 Pal |
|  accessories | 2 x C-1235, 523997V |



RECHTS / RIGHT / DROITE

CP2 000 49

85 384

16"

16"

Teile passend zu
parts interchangeable
Pièces adaptables pour

Överum

| | | |
|--|--|-----------|
| Scharblatt Wing / Aileron | | AX |
| LINKS / LEFT / GAUCHE CP2 000 52 94 599 14" | RECHTS / RIGHT / DROITE CP2 000 51 94 598 14" | |

| | |
|-------------|--|
| Unit weight | 3,60 |
| color | ■ rot |
| piece unit | 200 Pal |
| accessories | 2 x C-1235, 523997V |



| | | |
|--|--|-----------|
| Scharblatt Wing / Aileron | | XL |
| LINKS / LEFT / GAUCHE CP2 000 54 94 601 16" | RECHTS / RIGHT / DROITE CP2 000 53 94 600 16" | |

| | |
|-------------|--|
| Unit weight | 4,05 |
| color | ■ rot |
| piece unit | 200 Pal |
| accessories | 2 x C-1235, 523997V |



| | | |
|--|--|-----------|
| Scharblatt Wing / Aileron | | XL |
| LINKS / LEFT / GAUCHE CP2 000 36 94 603 18" | RECHTS / RIGHT / DROITE CP2 000 35 94 602 18" | |

| | |
|-------------|--|
| Unit weight | 4,60 |
| color | ■ rot |
| piece unit | 200 Pal |
| accessories | 2 x C-1235, 523997V |



| | | |
|---|---|--|
| Scharblatt Wing / Aileron | | |
| LINKS / LEFT / GAUCHE CP2 001 13 96091 | RECHTS / RIGHT / DROITE CP2 001 12 96090 | |

| | |
|-------------|--|
| Unit weight | 4,20 |
| color | ■ rot |
| piece unit | 300 Pal |
| accessories | 2 x C-1235, 523997V |



| | |
|--|--|
| Schare Share / Soc | |
| RECHTS / RIGHT / DROITE CP2 000 03 74 904 | |

| | |
|-------------|--|
| Unit weight | 4,10 |
| color | ■ rot |
| piece unit | 150 Pal |
| accessories | |



| | |
|---|---|
| Schare Share / Soc | |
| LINKS / LEFT / GAUCHE CP2 001 88 96093 | RECHTS / RIGHT / DROITE CP2 000 88 96092 |

| | |
|-------------|--|
| Unit weight | 4,60 |
| color | ■ rot |
| piece unit | 150 Pal |
| accessories | 2 x C-1235, 523997V |



| | |
|--|--|
| Streichschiene Tailpress / Rallonge de Versoir | |
| LINKS / LEFT / GAUCHE CP2 000 99 80 559 | RECHTS / RIGHT / DROITE CP2 000 98 74 922 |

| | |
|-------------|--|
| Unit weight | 1,55 |
| color | ■ blau |
| piece unit | 500 Pal |
| accessories | |



| | |
|--|--|
| Streifen Strips for slated body / Lame pour clair Voie | |
| LINKS / LEFT / GAUCHE CP2 001 03 20 894 A | RECHTS / RIGHT / DROITE CP2 001 02 20 249 A |

| | |
|-------------|--|
| Unit weight | 2,60 |
| color | ■ blau |
| piece unit | 400 Pal |
| accessories | 3 x C-1235, 523997V |



Teile passend zu
parts interchangeable
Pièces adaptables pour

Överum

Streifen

Strips for slated body / Lame pour clair Voie

LINKS / LEFT / GAUCHE





CP2 001 05

20 895 B

RECHTS / RIGHT / DROITE

CP2 001 04

20 250 B

| | |
|---|--|
|  Unit weight | 3,10 |
|  color |  blau |
|  piece unit | 300 Pal |
|  accessories | 2 x C-1235, 523997V |



Streifen

Strips for slated body / Lame pour clair Voie

LINKS / LEFT / GAUCHE





CP2 001 07

20 896 C

RECHTS / RIGHT / DROITE

CP2 001 06

20 251 C

| | |
|---|---|
|  Unit weight | 3,70 |
|  color |  blau |
|  piece unit | 250 Pal |
|  accessories | 2 x C-1235, 523997V |



Streifen

Strips for slated body / Lame pour clair Voie

LINKS / LEFT / GAUCHE





CP2 001 09

20897

RECHTS / RIGHT / DROITE

CP2 001 08

20 252 D

| | |
|---|--|
|  Unit weight | 6,15 |
|  color |  blau |
|  piece unit | 150 Pal |
|  accessories | 3 x C-1235, 523997V |



Verschleißstück - Streichblech - Vorderteil

Wearing part - Moulboard - Front part / Etrave

LINKS / LEFT / GAUCHE





CP2 001 01

21 599

RECHTS / RIGHT / DROITE

CP2 001 00

21 470

| | |
|---|---|
|  Unit weight | 3,20 |
|  color |  blau |
|  piece unit | 300 Pal |
|  accessories | 2 x C-1235, 523997V |



Verschleißstück - Streichblech - Vorderteil





Wearing part - Moulboard - Front part / Etrave

RECHTS / RIGHT / DROITE

CP2 000 13

74 871

SR; SRA

| | |
|---|---|
|  Unit weight | 1,70 |
|  color |  rot |
|  piece unit | 500 Pal |
|  accessories | 2 x C-1235, 523997V |



Verschleißstück - Streichblech - Vorderteil

Wearing part - Moulboard - Front part / Etrave

LINKS / LEFT / GAUCHE

CP2 000 38





94 597

RECHTS / RIGHT / DROITE

CP2 000 37

94 596

AX

| | |
|---|--|
|  Unit weight | 1,35 |
|  color |  rot |
|  piece unit | 500 Pal |
|  accessories | 2 x C-1235, 523997V |

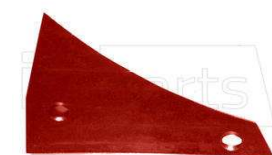

Teile passend zu
parts interchangeable
Pièces adaptables pour

Pöttinger Landsberg

Anlage

Landside / Contre-Sep

LINKS / LEFT / GAUCHE





CLO 000 17

000 814Z

RECHTS / RIGHT / DROITE

CLO 000 16

000 813Z

| | |
|---|---|
|  Unit weight | 3,50 |
|  color |  rot |
|  piece unit | 300 Pal |
|  accessories | 1 x A-1660, 545200V |



Anlage

Landside / Contre-Sep

LINKS / LEFT / GAUCHE





CLO 000 23

001 498Z

RECHTS / RIGHT / DROITE

CLO 000 22

001 497Z

| | |
|---|--|
|  Unit weight | 6,50 |
|  color |  rot |
|  piece unit | 150 Pal |
|  accessories | 1 x A-1660, 545200V |



Anlage

Landside / Contre-Sep

LINKS / LEFT / GAUCHE





CLO 000 21

001 500Z

RECHTS / RIGHT / DROITE

CLO 000 20

001 499Z

| | |
|---|---|
|  Unit weight | 5,20 |
|  color |  rot |
|  piece unit | 200 Pal |
|  accessories | 1 x A-1660, 545200V |







Anlage

Landside / Contre-Sep

CLO 001 04

929 10 010 1

| | |
|---|--|
|  Unit weight | 5,90 |
|  color |  rot |
|  piece unit | 200 Pal |
|  accessories | 3 x G-1240, 523732V |







Anlagenschoner

Landside Protection / Protection de Contre-Sep

CLO 000 95

929 10 021 0

| | |
|---|---|
|  Unit weight | 7,00 |
|  color |  rot |
|  piece unit | 150 Pal |
|  accessories | 2 x D-1240, 546200V |







Anlagenschoner

Landside Protection / Protection de Contre-Sep

CLO 000 96

929.10.020.1

| | |
|---|--|
|  Unit weight | 4,10 |
|  color |  rot |
|  piece unit | 250 Pal |
|  accessories | 2 x D-1240, 546200V |



Anlagenspitze

Landside top / Pointe de Contre Sep

LINKS / LEFT / GAUCHE





CLO 001 06

929 10 0050

RECHTS / RIGHT / DROITE

CLO 001 05

929 10 0001

| | |
|---|---|
|  Unit weight | 1,00 |
|  color |  rot |
|  piece unit | 1 000 Pal |
|  accessories | 2 x G-1240, 523732V |

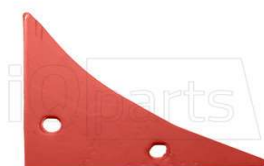

Anlagenspitze

Landside top / Pointe de Contre Sep

LINKS / LEFT / GAUCHE





CLO 001 42

929.10.105.0

RECHTS / RIGHT / DROITE

CLO 001 41

929.10.100.0

| | |
|---|--|
|  Unit weight | 1,45 |
|  color |  rot |
|  piece unit | 500 Pal |
|  accessories | |



Teile passend zu
parts interchangeable
Pièces adaptables pour

Pöttinger Landsberg

Anlagenspitze

Landside top / Pointe de Contre Sep

LINKS / LEFT / GAUCHE





CLO 001 08

930 71 0050

RECHTS / RIGHT / DROITE

CLO 001 07

930 70 0050

| | |
|---|---|
|  Unit weight | 2,00 |
|  color |  rot |
|  piece unit | 500 Pal |
|  accessories | 2 x G-1240, 523732V |

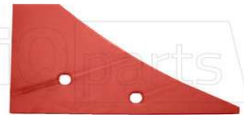

Anlagenspitze

Landside top / Pointe de Contre Sep

LINKS / LEFT / GAUCHE





CLO 001 32

930 77 005 1

RECHTS / RIGHT / DROITE

CLO 001 31

930 76 005 1

| | |
|---|--|
|  Unit weight | 2,18 |
|  color |  rot |
|  piece unit | 500 Pal |
|  accessories | |



Anlagenspitze

Landside top / Pointe de Contre Sep

LINKS / LEFT / GAUCHE





CLO 001 34

930 79 005 0+1

RECHTS / RIGHT / DROITE

CLO 001 33

930 78 005 0+1

| | |
|---|---|
|  Unit weight | 1,90 |
|  color |  rot |
|  piece unit | 500 Pal |
|  accessories | |



Düngereinlegeblech

Skimmer Board / Versoirs de Rasette

LINKS / LEFT / GAUCHE





CK0 001 13

073301

RECHTS / RIGHT / DROITE

CK0 001 12

073300

| | |
|---|---|
|  Unit weight | 3,32 |
|  color |  grün |
|  piece unit | 300 Pal |
|  accessories | 2 x C-1235, 523997V |



Düngereinlegeblech

Skimmer Board / Versoirs de Rasette

LINKS / LEFT / GAUCHE





CLO 000 25

190 36 98

RECHTS / RIGHT / DROITE

CLO 000 24

190 36 97

| | |
|---|---|
|  Unit weight | 2,50 |
|  color |  rot |
|  piece unit | 300 Pal |
|  accessories | 2 x D-1030, 523742V |



Düngereinlegeschar

Skim Point / Soc de Rasette

LINKS / LEFT / GAUCHE





CLO 000 15

001 848Z

RECHTS / RIGHT / DROITE

CLO 000 14

001 847Z

| | |
|---|--|
|  Unit weight | 1,40 |
|  color |  rot |
|  piece unit | 500 Pal |
|  accessories | 2 x D-1235 11014D123 |



Düngereinlegeschar

Skim Point / Soc de Rasette

LINKS / LEFT / GAUCHE





CLO 000 31

1903694 12MM 0379860

RECHTS / RIGHT / DROITE

CLO 000 30

1903693 12MM 0379850

| | |
|---|---|
|  Unit weight | 1,83 |
|  color |  rot |
|  piece unit | 500 Pal |
|  accessories | 2 x D-1235 11014D123 |



Düngereinlegeschar

Skim Point / Soc de Rasette

LINKS / LEFT / GAUCHE





CLO 000 64

1903696 921041180 PA305501

RECHTS / RIGHT / DROITE

CLO 000 63

1903695 921041280 PA305401

| | |
|---|--|
|  Unit weight | 1,15 |
|  color |  rot |
|  piece unit | 500 Pal |
|  accessories | 2 x D-1235 11014D123 |



Teile passend zu
parts interchangeable
Pièces adaptables pour

Pöttinger Landsberg

Düngereinlegeschar

Skim Point / Soc de Rasette

LINKS / LEFT / GAUCHE





LZ1 357 01P

921 02 158 0

RECHTS / RIGHT / DROITE

LZ1 356 01P

921 02 148 0

| | |
|---|---------------------|
|  Unit weight | 1,70 |
|  color | rot |
|  piece unit | 500 Pal |
|  accessories | 2 x G-1240, 523732V |



Flügelschare

Winged share / Ailette de Dechaumeur

LINKS / LEFT / GAUCHE





CLO 001 14

976 250 020 0

RECHTS / RIGHT / DROITE

CLO 001 15

976 25 00301

| | |
|---|----------------------|
|  Unit weight | 1,76 |
|  color | rot |
|  piece unit | 300 Pal |
|  accessories | 1 x K-1665, 523782AV |



Halteplatte

Retaining Plate /

LINKS / LEFT / GAUCHE





CKO 001 15

073311

RECHTS / RIGHT / DROITE

CKO 001 14

073310

| | |
|---|---------|
|  Unit weight | 2,25 |
|  color | grün |
|  piece unit | 400 Pal |
|  accessories | |



Meissel - Wechselspitze

Reversible Point / Pointe Reversible

LINKS / LEFT / GAUCHE





CLO 000 88

925 13 021 1

RECHTS / RIGHT / DROITE

CLO 000 87

925 13 011 1

| | |
|---|----------------------|
|  Unit weight | 2,60 |
|  color | rot |
|  piece unit | 500 Pal |
|  accessories | 2 x D-1235 11014D123 |



Meissel - Wechselspitze

Reversible Point / Pointe Reversible

LINKS / LEFT / GAUCHE





CKO 000 04

063090

RECHTS / RIGHT / DROITE

CKO 000 03

053090

| | |
|---|---------------------|
|  Unit weight | 1,33 |
|  color | grün |
|  piece unit | 500 Pal |
|  accessories | 2 x G-1234, 523998V |



Meissel - Wechselspitze

Reversible Point / Pointe Reversible

LINKS / LEFT / GAUCHE





CK1 000 33

1903676

RECHTS / RIGHT / DROITE

CK1 000 32

9290990

| | |
|---|---------------------|
|  Unit weight | 1,08 |
|  color | rot |
|  piece unit | 500 Pal |
|  accessories | 2 x G-1234, 523998V |



Meissel - Wechselspitze

Reversible Point / Pointe Reversible

LINKS / LEFT / GAUCHE





CLO 000 88

925 13 021 0 UW

RECHTS / RIGHT / DROITE

CLO 000 87

925 1301 1 0 UW

| | |
|---|----------------------|
|  Unit weight | 2,60 |
|  color | rot |
|  piece unit | 500 Pal |
|  accessories | 2 x D-1235 11014D123 |



Meissel - Wechselspitze

Reversible Point / Pointe Reversible

LINKS / LEFT / GAUCHE





CLO 000 92

925 26 021 0 WSS

RECHTS / RIGHT / DROITE

CLO 000 91

925 26 011 0 WSS

| | |
|---|----------------------|
|  Unit weight | 2,60 |
|  color | rot |
|  piece unit | Pal |
|  accessories | 2 x D-1235 11014D123 |



Teile passend zu
parts interchangeable
Pièces adaptables pour

Pöttinger Landsberg

Meissel - Wechselspitze

Reversible Point / Pointe Reversible

LINKS / LEFT / GAUCHE





CLO 000 92

925 26 021 1

RECHTS / RIGHT / DROITE

CLO 000 91

925 26 011 1

| | |
|---|---|
|  Unit weight | 2,60 |
|  color |  rot |
|  piece unit | Pal |
|  accessories | 2 x D-1235 11014D123 |



Meissel - Wechselspitze

Reversible Point / Pointe Reversible

LINKS / LEFT / GAUCHE





CK1 000 33

M 1010

RECHTS / RIGHT / DROITE

CK1 000 32

M 1000

| | |
|---|--|
|  Unit weight | 1,08 |
|  color |  rot |
|  piece unit | 500 Pal |
|  accessories | 2 x G-1234, 523998V |







Mollblech -Streichblech

Mouldboard / Versoir

CLO 000 47

001 763Z

| | |
|---|---|
|  Unit weight | 9,10 |
|  color |  rot |
|  piece unit | 50 Pal |
|  accessories | 7 x D-1235 11014D123 |







Mollblech -Streichblech

Mouldboard / Versoir

LINKS / LEFT / GAUCHE

CLO 000 48

001 764Z

| | |
|---|--|
|  Unit weight | 9,10 |
|  color |  rot |
|  piece unit | 50 Pal |
|  accessories | 7 x D-1235 11014D123 |



Mollblech -Streichblech

Mouldboard / Versoir

LINKS / LEFT / GAUCHE

CK0 000 73

073287





RECHTS / RIGHT / DROITE

CK0 000 72

073286

14"

14"

| | |
|---|---|
|  Unit weight | 20,30 |
|  color |  rot |
|  piece unit | 50 Pal |
|  accessories | 10 x C-1235, 523997V |



Mollblech -Streichblech

Mouldboard / Versoir

LINKS / LEFT / GAUCHE

CK0 000 79

073291





14"

RECHTS / RIGHT / DROITE

CK0 000 78

073290

14"

| | |
|---|--|
|  Unit weight | 20,30 |
|  color |  rot |
|  piece unit | 50 Pal |
|  accessories | 10 x C-1235, 523997V |

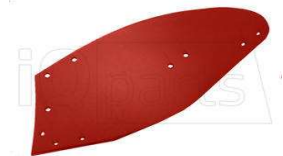





Mollblech -Streichblech

Mouldboard / Versoir

RECHTS / RIGHT / DROITE

CLO 000 51

190 3559Z

| | |
|---|---|
|  Unit weight | 14,50 |
|  color |  rot |
|  piece unit | 50 Pal |
|  accessories | 8 x D-1235 11014D123 |



Mollblech -Streichblech

Mouldboard / Versoir

LINKS / LEFT / GAUCHE





PK7 002 01BP

1903561z

RECHTS / RIGHT / DROITE

PK7 001 01BP

1903559z

| | |
|---|--|
|  Unit weight | 16,50 |
|  color |  rot |
|  piece unit | 50 Pal |
|  accessories | 4 x D-1035, 523801V 4 x D-1235 11014D123 |







Teile passend zu
parts interchangeable
Pièces adaptables pour

Pöttinger Landsberg

Mollblech -Streichblech

Mouldboard / Versoir

| LINKS / LEFT / GAUCHE | RECHTS / RIGHT / DROITE |
|-----------------------|-------------------------|
| CLO 001 01 | CLO 001 00 |
| 930 77 030 0 | 930 76 030 0 |





| | |
|---|---|
|  Unit weight | 19,80 |
|  color |  rot |
|  piece unit | 50 Pal |
|  accessories | 8 x C-1235, 523997V |



Mollblech -Streichblech

Mouldboard / Versoir

| LINKS / LEFT / GAUCHE | RECHTS / RIGHT / DROITE |
|-----------------------|-------------------------|
| CLO 001 01 | CLO 001 00 |
| 930 77 0330 46W | 930 76 0330 46W |





| | |
|---|--|
|  Unit weight | 19,80 |
|  color |  rot |
|  piece unit | 50 Pal |
|  accessories | 8 x C-1235, 523997V |



Mollblech -Streichblech

Mouldboard / Versoir

| LINKS / LEFT / GAUCHE | RECHTS / RIGHT / DROITE |
|-----------------------|-------------------------|
| CLO 001 01 | CLO 001 00 |
| 930 79 030 1 | 930 78 030 1 |





| | |
|---|---|
|  Unit weight | 19,80 |
|  color |  rot |
|  piece unit | 50 Pal |
|  accessories | 8 x C-1235, 523997V |



Scharblatt

Wing / Aileron

| LINKS / LEFT / GAUCHE | RECHTS / RIGHT / DROITE |
|-----------------------|-------------------------|
| CLO 000 36 | CLO 000 35 |
| 041 665z | 041 664z |





| | |
|---|--|
|  Unit weight | 3,83 |
|  color |  rot |
|  piece unit | 200 Pal |
|  accessories | 2 x D-1235 11014D123 |



Scharblatt

Wing / Aileron

| LINKS / LEFT / GAUCHE | RECHTS / RIGHT / DROITE |
|----------------------------|---------------------------|
| CLO 000 36 | CLO 000 35 |
| 190 3685 40-35UW 940 95032 | 190 3684 35-30UW 94095022 |





| | |
|---|---|
|  Unit weight | 3,83 |
|  color |  rot |
|  piece unit | 200 Pal |
|  accessories | 2 x D-1235 11014D123 |



Scharblatt

Wing / Aileron

| LINKS / LEFT / GAUCHE | RECHTS / RIGHT / DROITE |
|---------------------------|-------------------------|
| CLO 000 44 | |
| 190 3687 40-38UW 94095012 | |





| | |
|---|--|
|  Unit weight | 4,30 |
|  color |  rot |
|  piece unit | 200 Pal |
|  accessories | 2 x D-1235 11014D123 |



Scharblatt

Wing / Aileron

| LINKS / LEFT / GAUCHE | RECHTS / RIGHT / DROITE |
|-----------------------|-------------------------|
| CLO 000 36 | CLO 000 35 |
| 940 95 032 0 | 940 95 022 0 |





| | |
|---|---|
|  Unit weight | 3,83 |
|  color |  rot |
|  piece unit | 200 Pal |
|  accessories | 2 x D-1235 11014D123 |



Scharblatt

Wing / Aileron

| LINKS / LEFT / GAUCHE | RECHTS / RIGHT / DROITE |
|-----------------------|---------------------------|
| CLO 000 44 | CLO 000 43 |
| 942 95 012 0 | 1903686 940950020 40-38UW |

| | |
|---|--|
|  Unit weight | 4,30 |
|  color |  rot |
|  piece unit | 200 Pal |
|  accessories | 2 x D-1235 11014D123 |



Teile passend zu
parts interchangeable
Pièces adaptables pour

Pöttinger Landsberg

| | |
|--|--|
| Schare Share / Soc | |
| LINKS / LEFT / GAUCHE CLO 000 06 000 850Z | RECHTS / RIGHT / DROITE CLO 000 05 000 849Z |

| | |
|-------------|----------------------|
| Unit weight | 3,60 |
| color | rot |
| piece unit | 150 Pal |
| accessories | 2 x D-1235 11014D123 |



| | |
|--|--|
| Schare Share / Soc | |
| LINKS / LEFT / GAUCHE CLO 000 04 000 852Z | RECHTS / RIGHT / DROITE CLO 000 03 190 3040 |

| | |
|-------------|----------------------|
| Unit weight | 4,60 |
| color | rot |
| piece unit | 150 Pal |
| accessories | 2 x D-1235 11014D123 |



| | |
|--|--|
| Schare Share / Soc | |
| RECHTS / RIGHT / DROITE CLO 000 01 010 515Z | |

| | |
|-------------|----------------------|
| Unit weight | 4,50 |
| color | rot |
| piece unit | 150 Pal |
| accessories | 3 x D-1235 11014D123 |



| | |
|--|--|
| Schare Share / Soc | |
| LINKS / LEFT / GAUCHE CLO 000 06 190 3030 | RECHTS / RIGHT / DROITE CLO 000 05 190 3020 |

| | |
|-------------|----------------------|
| Unit weight | 3,60 |
| color | rot |
| piece unit | 150 Pal |
| accessories | 2 x D-1235 11014D123 |



| | |
|--|--|
| Schare Share / Soc | |
| LINKS / LEFT / GAUCHE CLO 000 04 190 3050 | RECHTS / RIGHT / DROITE CLO 000 03 190 3520 |

| | |
|-------------|----------------------|
| Unit weight | 4,60 |
| color | rot |
| piece unit | 150 Pal |
| accessories | 2 x D-1235 11014D123 |



| | |
|--|--|
| Schare Share / Soc | |
| RECHTS / RIGHT / DROITE CLO 000 01 190 3110 | |

| | |
|-------------|----------------------|
| Unit weight | 4,50 |
| color | rot |
| piece unit | 150 Pal |
| accessories | 3 x D-1235 11014D123 |



| | |
|--|--|
| Schare Share / Soc | |
| LINKS / LEFT / GAUCHE CLO 000 76 190 3518 | RECHTS / RIGHT / DROITE CLO 000 75 190 3517 |

| | |
|-------------|----------------------|
| Unit weight | 4,30 |
| color | rot |
| piece unit | 150 Pal |
| accessories | 3 x D-1235 11014D123 |



| | |
|---|---|
| Schare Share / Soc | |
| LINKS / LEFT / GAUCHE P93 002 01P 190 3558 | RECHTS / RIGHT / DROITE P93 001 01P 190 3557 |

| | |
|-------------|----------------------|
| Unit weight | 4,05 |
| color | rot |
| piece unit | 150 Pal |
| accessories | 3 x D-1235 11014D123 |



Teile passend zu
parts interchangeable
Pièces adaptables pour

Pöttinger Landsberg

Schare

Share / Soc

LINKS / LEFT / GAUCHE





CLO 000 06

925 04 000 0

RECHTS / RIGHT / DROITE

CLO 000 05

925 03 000 0

| | |
|---|---|
|  Unit weight | 3,60 |
|  color |  rot |
|  piece unit | 150 Pal |
|  accessories | 2 x D-1235 11014D123 |



Schare

Share / Soc

LINKS / LEFT / GAUCHE





P93 002 01P

925 22 0000

RECHTS / RIGHT / DROITE

P93 001 01P

925 21 000

| | |
|---|--|
|  Unit weight | 4,05 |
|  color |  rot |
|  piece unit | 150 Pal |
|  accessories | 3 x D-1235 11014D123 |







Schare

Share / Soc

RECHTS / RIGHT / DROITE

CLO 000 01

925 32 000 0

| | |
|---|---|
|  Unit weight | 4,50 |
|  color |  rot |
|  piece unit | 150 Pal |
|  accessories | 3 x D-1235 11014D123 |







Schare - Wechselspitzschare

Share for rev. Point / Soc pour pointe reversilbe

RECHTS / RIGHT / DROITE

CLO 000 79

041 317 Z

| | |
|---|--|
|  Unit weight | 4,55 |
|  color |  rot |
|  piece unit | 150 Pal |
|  accessories | 3 x D-1235 11014D123 |



Schare - Wechselspitzschare

Share for rev. Point / Soc pour pointe reversilbe

LINKS / LEFT / GAUCHE

CKO 000 38

073005





16"

RECHTS / RIGHT / DROITE

CKO 000 37

073004

16"

| | |
|---|--|
|  Unit weight | 5,50 |
|  color |  grün |
|  piece unit | 150 Pal |
|  accessories | 4 x F-1434, 523999V |



Schare - Wechselspitzschare

Share for rev. Point / Soc pour pointe reversilbe

LINKS / LEFT / GAUCHE

CKO 000 57

073007





18"

RECHTS / RIGHT / DROITE

CKO 000 56

073006 Nr.6-9

18"

| | |
|---|---|
|  Unit weight | 6,70 |
|  color |  grün |
|  piece unit | 150 Pal |
|  accessories | 4 x F-1434, 523999V |







Schare - Wechselspitzschare

Share for rev. Point / Soc pour pointe reversilbe

RECHTS / RIGHT / DROITE

CLO 000 79

190.36.71

| | |
|---|---|
|  Unit weight | 4,55 |
|  color |  rot |
|  piece unit | 150 Pal |
|  accessories | 3 x D-1235 11014D123 |



Schare - Wechselspitzschare

Share for rev. Point / Soc pour pointe reversilbe

LINKS / LEFT / GAUCHE





CLO 000 86

925 13 125 0

RECHTS / RIGHT / DROITE

CLO 000 85

925 13 1150

| | |
|---|--|
|  Unit weight | 5,37 |
|  color |  rot |
|  piece unit | 150 Pal |
|  accessories | 3 x D-1235 11014D123 |



Teile passend zu
parts interchangeable
Pièces adaptables pour

Pöttinger Landsberg

Schare - Wechselspitzschare

Share for rev. Point / Soc pour pointe reversilbe

LINKS / LEFT / GAUCHE





CLO 000 86

925 13 126 1

RECHTS / RIGHT / DROITE

CLO 000 85

925 13 116 1

| | |
|---|--|
|  Unit weight | 5,37 |
|  color | ■ rot |
|  piece unit | 150 Pal |
|  accessories | 3 x D-1235 11014D123 |



Schare - Wechselspitzschare

Share for rev. Point / Soc pour pointe reversilbe

LINKS / LEFT / GAUCHE





CLO 000 86

925 13126 0 UWS

RECHTS / RIGHT / DROITE

CLO 000 85

925 131160 UWS

| | |
|---|--|
|  Unit weight | 5,37 |
|  color | ■ rot |
|  piece unit | 150 Pal |
|  accessories | 3 x D-1235 11014D123 |



Schare - Wechselspitzschare

Share for rev. Point / Soc pour pointe reversilbe

LINKS / LEFT / GAUCHE





CLO 000 90

925 26 023 0 WSS

RECHTS / RIGHT / DROITE

CLO 000 89

925 26 013 0 WSS

| | |
|---|--|
|  Unit weight | 6,00 |
|  color | ■ rot |
|  piece unit | 150 Pal |
|  accessories | 3 x D-1235 11014D123 |



Schare - Wechselspitzschare

Share for rev. Point / Soc pour pointe reversilbe

LINKS / LEFT / GAUCHE





CLO 000 90

925 26 023 1

RECHTS / RIGHT / DROITE

CLO 000 89

925 26 013 1

| | |
|---|--|
|  Unit weight | 6,00 |
|  color | ■ rot |
|  piece unit | 150 Pal |
|  accessories | 3 x D-1235 11014D123 |



Schare - Wechselspitzschare

Share for rev. Point / Soc pour pointe reversilbe

LINKS / LEFT / GAUCHE

CLO 001 38

930 77 121 0





18"

RECHTS / RIGHT / DROITE

CLO 001 37

930 76 121 0

18"

| | |
|---|--|
|  Unit weight | 6,30 |
|  color | ■ rot |
|  piece unit | Pal |
|  accessories | |

Schare - Wechselspitzschare

Share for rev. Point / Soc pour pointe reversilbe

LINKS / LEFT / GAUCHE

CLO 001 38

930 79 122 0





18"

RECHTS / RIGHT / DROITE

CLO 001 37

930 78 122 0

18"

| | |
|---|--|
|  Unit weight | 6,30 |
|  color | ■ rot |
|  piece unit | Pal |
|  accessories | |

Scharspitze

Share point / Nez de Soc

LINKS / LEFT / GAUCHE





CLO 001 44

056462Z

RECHTS / RIGHT / DROITE

CLO 001 43

056461Z

| | |
|---|--|
|  Unit weight | 0,70 |
|  color | ■ rot |
|  piece unit | 800 Pal |
|  accessories | |

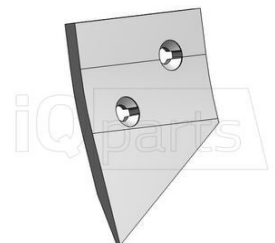

Streichschiene

Tailpress / Rallonge de Versoir

LINKS / LEFT / GAUCHE





CKO 000 89

063388

RECHTS / RIGHT / DROITE

CKO 000 88

053387

| | |
|---|--|
|  Unit weight | 1,92 |
|  color | ■ rot |
|  piece unit | 500 Pal |
|  accessories | |



Teile passend zu
parts interchangeable
Pièces adaptables pour

Pöttinger Landsberg

Streifen

Strips for slated body / Lame pour clair Voie





LINKS / LEFT / GAUCHE RECHTS / RIGHT / DROITE

CLO 001 21

CLO 001 20

041 873B

041 872B

| | |
|---|---------------------|
|  Unit weight | 5,60 |
|  color | rot |
|  piece unit | 150 Pal |
|  accessories | 2 x D-1240, 546200V |



Streifen

Strips for slated body / Lame pour clair Voie





LINKS / LEFT / GAUCHE RECHTS / RIGHT / DROITE

CLO 001 23

CLO 001 22

041 875A

041 874A

| | |
|---|---------------------|
|  Unit weight | 4,75 |
|  color | rot |
|  piece unit | 200 Pal |
|  accessories | 2 x D-1240, 546200V |



Streifen

Strips for slated body / Lame pour clair Voie





LINKS / LEFT / GAUCHE RECHTS / RIGHT / DROITE

CLO 001 25

CLO 001 24

041 877A

041 876A

| | |
|---|---------------------|
|  Unit weight | 3,10 |
|  color | rot |
|  piece unit | 300 Pal |
|  accessories | 2 x D-1240, 546200V |



Streifen

Strips for slated body / Lame pour clair Voie





LINKS / LEFT / GAUCHE RECHTS / RIGHT / DROITE

CLO 001 27

CLO 001 26

041 879A

041 878A

| | |
|---|---------------------|
|  Unit weight | 3,05 |
|  color | rot |
|  piece unit | 300 Pal |
|  accessories | 4 x D-1240, 546200V |



Verschleißstück - Streichblech - Vorderteil

Wearing part - Moulboard - Front part / Etrave





LINKS / LEFT / GAUCHE RECHTS / RIGHT / DROITE

CLO 000 62

CLO 000 61

001 766Z

001 765Z

| | |
|---|----------------------|
|  Unit weight | 1,45 |
|  color | rot |
|  piece unit | 500 Pal |
|  accessories | 2 x D-1235 11014D123 |



Verschleißstück - Streichblech - Vorderteil

Wearing part - Moulboard - Front part / Etrave





LINKS / LEFT / GAUCHE RECHTS / RIGHT / DROITE

CLO 001 29

CLO 001 28

041 885A

041 884A

| | |
|---|---------------------|
|  Unit weight | 2,40 |
|  color | rot |
|  piece unit | 400 Pal |
|  accessories | 3 x D-1240, 546200V |



Verschleißstück - Streichblech - Vorderteil

Wearing part - Moulboard - Front part / Etrave





LINKS / LEFT / GAUCHE RECHTS / RIGHT / DROITE

CKO 000 63

CKO 000 62

073251

073250

| | |
|---|---------------------|
|  Unit weight | 1,44 |
|  color | rot |
|  piece unit | 500 Pal |
|  accessories | 2 x C-1235, 523997V |



Verschleißstück - Streichblech - Vorderteil

Wearing part - Moulboard - Front part / Etrave





LINKS / LEFT / GAUCHE RECHTS / RIGHT / DROITE

CKO 000 81

CKO 000 80

073257

073256

| | |
|---|---------------------|
|  Unit weight | 1,58 |
|  color | rot |
|  piece unit | 500 Pal |
|  accessories | 3 x C-1235, 523997V |



Teile passend zu
parts interchangeable
Pièces adaptables pour

Pöttinger Landsberg

Verschleißstück - Streichblech - Vorderteil Wearing part - Moulboard - Front part / Etrave

RECHTS / RIGHT / DROITE

CLO 000 55

190 2020

| | |
|-------------|--|
| Unit weight | 1,40 |
| color | ■ rot |
| piece unit | 600 Pal |
| accessories | 2 x D-1240, 546200V |



Verschleißstück - Streichblech - Vorderteil Wearing part - Moulboard - Front part / Etrave

LINKS / LEFT / GAUCHE

PK6 006 00BP

190 3563

| | |
|-------------|--|
| Unit weight | 0,96 |
| color | ■ rot |
| piece unit | 400 Pal |
| accessories | 1 x D-1030, 523742V |



Verschleißstück - Streichblech - Vorderteil Wearing part - Moulboard - Front part / Etrave

LINKS / LEFT / GAUCHE

CLO 001 03

930 77 035 0

| | |
|-------------|--|
| Unit weight | 2,45 |
| color | ■ rot |
| piece unit | 400 Pal |
| accessories | 3 x C-1235, 523997V |



RECHTS / RIGHT / DROITE

CLO 001 02

930 76 035 0

Verschleißstück - Streichblech - Vorderteil Wearing part - Moulboard - Front part / Etrave

LINKS / LEFT / GAUCHE

CLO 001 03

930 77 0370 46W

| | |
|-------------|--|
| Unit weight | 2,45 |
| color | ■ rot |
| piece unit | 400 Pal |
| accessories | 3 x C-1235, 523997V |



RECHTS / RIGHT / DROITE

CLO 001 02

930 76 0370 46W

Teile passend zu
parts interchangeable
Pièces adaptables pour





RABE

Anlage

Landside / Contre-Sep

CRO 000 90

27011401 WP292-0 27011400

| | |
|---|--|
|  Unit weight | 5,50 |
|  color |  blau |
|  piece unit | 150 Pal |
|  accessories | 5 x B-1235 - 3015785, 5 |







Anlage

Landside / Contre-Sep

CRO 000 89

27011500 VP 292 0

| | |
|---|---|
|  Unit weight | 3,50 |
|  color |  blau |
|  piece unit | 300 Pal |
|  accessories | 2 x B-1235 - 3015785, 5 |







Anlage

Landside / Contre-Sep

CRO 000 60

27080701 WP203-0 LG525

| | |
|---|--|
|  Unit weight | 3,91 |
|  color |  blau |
|  piece unit | 250 Pal |
|  accessories | 5 x B-1235 - 3015785, 5 |







Anlage

Landside / Contre-Sep

CRO 000 57

27080702 VP2020 LG255

| | |
|---|---|
|  Unit weight | 2,53 |
|  color |  blau |
|  piece unit | 400 Pal |
|  accessories | 2 x B-1235 - 3015785, 5 |







Anlage

Landside / Contre-Sep

CRO 002 26

27510305 WP351W

| | |
|---|--|
|  Unit weight | 5,80 |
|  color |  blau |
|  piece unit | 150 Pal |
|  accessories | 3 x B-1240 2700 2607, |







Anlage

Landside / Contre-Sep

CRO 002 25

27510306 VP 351W

| | |
|---|---|
|  Unit weight | 3,50 |
|  color |  blau |
|  piece unit | 300 Pal |
|  accessories | 2 x B-1240 2700 2607, |







Anlage

Landside / Contre-Sep

NIO 240 72

2761 0120

| | |
|---|---|
|  Unit weight | 5,05 |
|  color |  rot |
|  piece unit | 200 Pal |
|  accessories | 1 x A-1650-M16 x 50 mit sf 1 x M-1240 M12x40, 5C |







Anlagenkeil

Landside Tip / Nez de contre-sep

NIO 240 13

2761 0121

| | |
|---|--|
|  Unit weight | 1,63 |
|  color |  rot |
|  piece unit | 700 Pal |
|  accessories | 2 x M-1240 M12x40, 5C |



Teile passend zu
parts interchangeable
Pièces adaptables pour





RABE

Anlagerschoner

Landside Protection / Protection de Contre-Sep

CRO 001 50

27081400 XP-6

| | |
|---|--|
|  Unit weight | 3,50 |
|  color |  blau |
|  piece unit | 300 Pal |
|  accessories | 4 x B-1235 - 3015785, 5 |

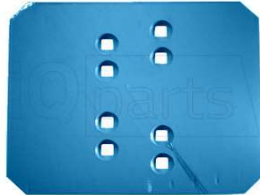





Anlagerschoner

Landside Protection / Protection de Contre-Sep

CRO 001 51

XP-4 2708 1500

| | |
|---|---|
|  Unit weight | 0,90 |
|  color |  blau |
|  piece unit | 100 Pal |
|  accessories | 3 x B-1235 - 3015785, 5 |







Anlagerspitze

Landside top / Pointe de Contre Sep

CRO 002 03

YP 350W 2751 0205

| | |
|---|--|
|  Unit weight | 1,15 |
|  color |  blau |
|  piece unit | 800 Pal |
|  accessories | 2 x B-1240 2700 2607, |







Düngereinlegeblech

Skimmer Board / Versoirs de Rasette

LINKS / LEFT / GAUCHE

CRO 002 30

27150802 RDG 181L

| | |
|---|---|
|  Unit weight | 2,00 |
|  color |  blau |
|  piece unit | 400 Pal |
|  accessories | 4 x B-1030, 547900V |

RECHTS / RIGHT / DROITE

CRO 002 29

27150801 RDG 181

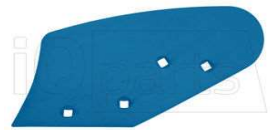





Düngereinlegeschar

Skim Point / Soc de Rasette

LINKS / LEFT / GAUCHE

CRO 000 82

27150102 SDG 181L

| | |
|---|--|
|  Unit weight | 0,92 |
|  color |  blau |
|  piece unit | 800 Pal |
|  accessories | 2 x B-1035 608D1035N |



RECHTS / RIGHT / DROITE

CRO 000 81

27150101 SDG 181





Düngereinlegeschar

Skim Point / Soc de Rasette

LINKS / LEFT / GAUCHE

CRO 000 82V

27150102 SDG 181L 10mm

| | |
|---|---|
|  Unit weight | 1,20 |
|  color |  blau |
|  piece unit | 800 Pal |
|  accessories | 2 x B-1035 608D1035N |



RECHTS / RIGHT / DROITE

CRO 000 81V

27150101 SDG 181 10mm





Düngereinlegeschar

Skim Point / Soc de Rasette

LINKS / LEFT / GAUCHE

CRO 000 80

27420202 SDG 14/16 L

| | |
|---|--|
|  Unit weight | 1,00 |
|  color |  blau |
|  piece unit | 800 Pal |
|  accessories | 2 x B-1035 608D1035N |



RECHTS / RIGHT / DROITE

CRO 000 79

27420201 SDG 14/16





Meissel - Wechselspitze

Reversible Point / Pointe Reversible

LINKS / LEFT / GAUCHE

CRO 001 24

27011202 MP 293 L

| | |
|---|---|
|  Unit weight | 1,50 |
|  color |  blau |
|  piece unit | 500 Pal |
|  accessories | 2 x O-1235 M12x35 Mu |



RECHTS / RIGHT / DROITE

CRO 001 23

27011201 MP 293

Teile passend zu
parts interchangeable
Pièces adaptables pour

RABE

Meissel - Wechselspitze

Reversible Point / Pointe Reversible

LINKS / LEFT / GAUCHE





CRO 001 26

27082802 MP 332 L

RECHTS / RIGHT / DROITE

CRO 001 25

27082801 MP 332

| | |
|---|--|
|  Unit weight | 1,20 |
|  color | ■ blau |
|  piece unit | 500 Pal |
|  accessories | 2 x O-1235 M12x35 Mu |



Meissel - Wechselspitze

Reversible Point / Pointe Reversible

LINKS / LEFT / GAUCHE





CRO 001 49

27510902 MP 350 L

RECHTS / RIGHT / DROITE

CRO 001 48

27510901 MP 350

| | |
|---|--|
|  Unit weight | 1,22 |
|  color | ■ blau |
|  piece unit | 500 Pal |
|  accessories | 2 x O-1235 M12x35 Mu |



Mollblech -Streichblech

Mouldboard / Versoir

LINKS / LEFT / GAUCHE





CRO 001 44

27010802 HRP 327-P Li

RECHTS / RIGHT / DROITE

CRO 001 43

27010801 HRP 327-P Re

| | |
|---|--|
|  Unit weight | 15,60 |
|  color | ■ blau |
|  piece unit | 50 Pal |
|  accessories | 7 x B-1235 - 3015785, 5 |



Scharblatt

Wing / Aileron

LINKS / LEFT / GAUCHE





NIO 241 21

2761 0124

RECHTS / RIGHT / DROITE

NIO 241 22

024122 NH6G

| | |
|---|--|
|  Unit weight | 4,60 |
|  color | ■ rot |
|  piece unit | 200 Pal |
|  accessories | 3 x D-1235 11014D123 |



Schare

Share / Soc

LINKS / LEFT / GAUCHE





CRO 000 72

27004802 SSP2930/OE 27001002

RECHTS / RIGHT / DROITE

CRO 000 71

27004801 SSP2930/OE 27001001

| | |
|---|--|
|  Unit weight | 6,60 |
|  color | ■ blau |
|  piece unit | 150 Pal |
|  accessories | 3 x B-1240 2700 2607, |



Schare

Share / Soc

LINKS / LEFT / GAUCHE





CRO 000 96

27070502 SSP 294 OL / OEL

RECHTS / RIGHT / DROITE

CRO 000 95

27070501 SSP 294 O / OE

| | |
|---|--|
|  Unit weight | 7,00 |
|  color | ■ blau |
|  piece unit | 150 Pal |
|  accessories | 3 x B-1240 2700 2607, |



Schare

Share / Soc

LINKS / LEFT / GAUCHE





CRO 000 68

27081602 SSP 200 JBL

RECHTS / RIGHT / DROITE

CRO 000 67

27081601 SSP 200 JB

| | |
|---|--|
|  Unit weight | 4,20 |
|  color | ■ blau |
|  piece unit | 150 Pal |
|  accessories | 2 x B-1240 2700 2607, |



Schare

Share / Soc

LINKS / LEFT / GAUCHE





CRO 001 08

27083102 SSP 332 OL

RECHTS / RIGHT / DROITE

CRO 001 07

27083101 SSP 332 O

| | |
|---|--|
|  Unit weight | 4,75 |
|  color | ■ blau |
|  piece unit | 150 Pal |
|  accessories | 3 x B-1240 2700 2607, |



Teile passend zu
parts interchangeable
Pièces adaptables pour

RABE

| Schare Share / Soc | |
|---|--|
| LINKS / LEFT / GAUCHE | RECHTS / RIGHT / DROITE |
| CRO 001 54 27512302 SSP350WL 27512802 | CRO 001 53 27512301 SSP350W 27512801 |
| Unit weight 7,50 | |
| color blau | |
| piece unit 150 Pal | |
| accessories 4 x B-1240 2700 2607, | |



| Schare Share / Soc | |
|-----------------------------------|---------------------------------|
| LINKS / LEFT / GAUCHE | RECHTS / RIGHT / DROITE |
| CRO 002 28 SSP 351 WEL | CRO 002 27 SSP 351 WE |
| Unit weight 8,50 | |
| color blau | |
| piece unit 100 Pal | |
| accessories 4 x B-1240 2700 2607, | |



| Schare Share / Soc | |
|--|---|
| LINKS / LEFT / GAUCHE | RECHTS / RIGHT / DROITE |
| CRO 001 20 SSP 351WEPL 2751 3002 | CRO 001 19 SSP 351WEP 2751 3001 |
| Unit weight 8,50 | |
| color blau | |
| piece unit 100 Pal | |
| accessories 4 x B-1240 2700 2607, | |



| Schare Share / Soc | |
|--|--|
| LINKS / LEFT / GAUCHE | RECHTS / RIGHT / DROITE |
| CRO 000 96H SSP-294-0 hardface | CRO 000 95H SSP-294-0 hardface |
| Unit weight 7,35 | |
| color blau | |
| piece unit 150 Pal | |
| accessories 3 x B-1240 2700 2607, | |



| Schare Share / Soc | |
|--|---|
| LINKS / LEFT / GAUCHE | RECHTS / RIGHT / DROITE |
| CRO 001 54H SSP-350WL hardface | CRO 001 53H SSP-350W hardface |
| Unit weight 7,70 | |
| color blau | |
| piece unit 150 Pal | |
| accessories 4 x B-1240 2700 2607, | |



| Schare - Wechselspitzschare Share for rev. Point / Soc pour pointe reversilbe | |
|--|--|
| LINKS / LEFT / GAUCHE | RECHTS / RIGHT / DROITE |
| CRO 000 74 27013302 SSP 293 OSL/OSEL | CRO 000 73 27013301 SSP 293 OS/OSE |
| Unit weight 6,40 | |
| color blau | |
| piece unit 150 Pal | |
| accessories 3 x B-1240 2700 2607, | |



| Schare - Wechselspitzschare Share for rev. Point / Soc pour pointe reversilbe | |
|--|--|
| LINKS / LEFT / GAUCHE | RECHTS / RIGHT / DROITE |
| CRO 000 98 27070402 SSP 294 OSL/OSEL | CRO 000 97 27070401 SSP 294 OS/OSE |
| Unit weight 7,50 | |
| color blau | |
| piece unit 150 Pal | |
| accessories 3 x B-1240 2700 2607, | |



| Schare - Wechselspitzschare Share for rev. Point / Soc pour pointe reversilbe | |
|--|---|
| LINKS / LEFT / GAUCHE | RECHTS / RIGHT / DROITE |
| CRO 001 22 27081702 SSP 331 OSL | CRO 001 21 27081701 SSP331OS 440162 |
| Unit weight 5,20 | |
| color blau | |
| piece unit 200 Pal | |
| accessories 3 x B-1240 2700 2607, | |



Teile passend zu
parts interchangeable
Pièces adaptables pour

RABE

Schare - Wechselspitzschare

Share for rev. Point / Soc pour pointe reversilbe

LINKS / LEFT / GAUCHE





CRO 000 86

27082702 SSP 332 OSL

RECHTS / RIGHT / DROITE

CRO 000 85

27082701 SSP 332 OS

| | |
|---|--|
|  Unit weight | 5,10 |
|  color |  blau |
|  piece unit | 150 Pal |
|  accessories | 3 x B-1240 2700 2607, |



Schare - Wechselspitzschare

Share for rev. Point / Soc pour pointe reversilbe

LINKS / LEFT / GAUCHE





CRO 001 56

27512202 SSP 350 WSEL

RECHTS / RIGHT / DROITE

CRO 001 55

27512201 SSP 350 WSE

| | |
|---|---|
|  Unit weight | 6,65 |
|  color |  blau |
|  piece unit | 150 Pal |
|  accessories | 4 x B-1240 2700 2607, |







Schare - Wechselspitzschare

Share for rev. Point / Soc pour pointe reversilbe

LINKS / LEFT / GAUCHE

CRO 001 61

467120 SSP 401 FM

| | |
|---|--|
|  Unit weight | 6,40 |
|  color |  blau |
|  piece unit | 150 Pal |
|  accessories | 3 x B-1240 2700 2607, |



Scharspitze

Share point / Nez de Soc

LINKS / LEFT / GAUCHE





NIO 241 39

2761 0127

RECHTS / RIGHT / DROITE

NIO 241 40

200678 SH15G hardface

| | |
|---|--|
|  Unit weight | 2,40 |
|  color |  rot |
|  piece unit | 400 Pal |
|  accessories | 2 x D-1235 11014D123 |



Streifen

Strips for slated body / Lame pour clair Voie

LINKS / LEFT / GAUCHE





CRO 002 21

27280202 SRP 236 OL1

RECHTS / RIGHT / DROITE

CRO 002 17

27280201 SRP 236 O1

| | |
|---|--|
|  Unit weight | 1,90 |
|  color |  blau |
|  piece unit | 500 Pal |
|  accessories | 4 x B-1235 - 3015785, 5 |



Streifen

Strips for slated body / Lame pour clair Voie

LINKS / LEFT / GAUCHE





CRO 002 22

27280302 SRP 236 OL2

RECHTS / RIGHT / DROITE

CRO 002 18

27280301 SRP 236 O2

| | |
|---|---|
|  Unit weight | 2,00 |
|  color |  blau |
|  piece unit | 500 Pal |
|  accessories | 2 x B-1235 - 3015785, 5 |



Streifen

Strips for slated body / Lame pour clair Voie

LINKS / LEFT / GAUCHE





CRO 002 23

27280402 SRP 236 OL3

RECHTS / RIGHT / DROITE

CRO 002 19

27280401 SRP 236 O3

| | |
|---|--|
|  Unit weight | 3,00 |
|  color |  blau |
|  piece unit | 300 Pal |
|  accessories | 2 x B-1235 - 3015785, 5 |



Streifen

Strips for slated body / Lame pour clair Voie

LINKS / LEFT / GAUCHE





CRO 002 24

27280502 SRP 236 OL4

RECHTS / RIGHT / DROITE

CRO 002 20

27280501 SRP 236 O4

| | |
|---|---|
|  Unit weight | 2,80 |
|  color |  blau |
|  piece unit | 350 Pal |
|  accessories | 2 x B-1235 - 3015785, 5 |



Teile passend zu
parts interchangeable
Pièces adaptables pour

RABE

Streifen

Strips for slated body / Lame pour clair Voie

LINKS / LEFT / GAUCHE





CRO 001 71

27310902 SRP 328 PL1

RECHTS / RIGHT / DROITE

CRO 001 70

27310901 SRP 328 P1

| | |
|---|--|
|  Unit weight | 3,55 |
|  color |  blau |
|  piece unit | 250 Pal |
|  accessories | 4 x B-1235 - 3015785, 5 |



Streifen

Strips for slated body / Lame pour clair Voie

LINKS / LEFT / GAUCHE





CRO 001 73

27311002 SRP 328 PL2

RECHTS / RIGHT / DROITE

CRO 001 72

27311001 SRP 328 P2

| | |
|---|---|
|  Unit weight | 3,75 |
|  color |  blau |
|  piece unit | 250 Pal |
|  accessories | 2 x B-1235 - 3015785, 5 |



Streifen

Strips for slated body / Lame pour clair Voie

LINKS / LEFT / GAUCHE





CRO 001 75

27311102 SRP 328 PL3

RECHTS / RIGHT / DROITE

CRO 001 74

27311101 SRP 328 P3

| | |
|---|--|
|  Unit weight | 5,80 |
|  color |  blau |
|  piece unit | 150 Pal |
|  accessories | 2 x B-1235 - 3015785, 5 |



Streifen

Strips for slated body / Lame pour clair Voie

LINKS / LEFT / GAUCHE





CRO 001 77

27311202 SRP 328 PL4

RECHTS / RIGHT / DROITE

CRO 001 76

27311201 SRP 328 P4

| | |
|---|---|
|  Unit weight | 5,25 |
|  color |  blau |
|  piece unit | 200 Pal |
|  accessories | 2 x B-1235 - 3015785, 5 |



Streifen

Strips for slated body / Lame pour clair Voie

LINKS / LEFT / GAUCHE





CRO 000 18

27550102 SRP 350 W1L

RECHTS / RIGHT / DROITE

CRO 000 17

27550101 SRP 350 W1

| | |
|---|--|
|  Unit weight | 3,85 |
|  color |  blau |
|  piece unit | 250 Pal |
|  accessories | 4 x B-1235 - 3015785, 5 |



Streifen

Strips for slated body / Lame pour clair Voie

LINKS / LEFT / GAUCHE





CRO 000 20

27550202 SRP 350 W2L

RECHTS / RIGHT / DROITE

CRO 000 19

27550201 SRP 350 W2

| | |
|---|---|
|  Unit weight | 4,25 |
|  color |  blau |
|  piece unit | 200 Pal |
|  accessories | 2 x B-1235 - 3015785, 5 |



Streifen

Strips for slated body / Lame pour clair Voie

LINKS / LEFT / GAUCHE





CRO 000 22

27550302 SRP 350 W3L

RECHTS / RIGHT / DROITE

CRO 000 21

27550301 SRP 350 W3

| | |
|---|--|
|  Unit weight | 5,45 |
|  color |  blau |
|  piece unit | 150 Pal |
|  accessories | 2 x B-1235 - 3015785, 5 |



Streifen

Strips for slated body / Lame pour clair Voie

LINKS / LEFT / GAUCHE





CRO 000 24

27550402 SRP 350 W4L

RECHTS / RIGHT / DROITE

CRO 000 23

27550401 SRP 350 W4

| | |
|---|---|
|  Unit weight | 7,70 |
|  color |  blau |
|  piece unit | 100 Pal |
|  accessories | 2 x B-1235 - 3015785, 5 |



Teile passend zu
parts interchangeable
Pièces adaptables pour

RABE

Streifen

Strips for slated body / Lame pour clair Voie





LINKS / LEFT / GAUCHE RECHTS / RIGHT / DROITE

CRO 002 34

CRO 002 33

27550702 SRP 350 W41L

27550701 SRP 350 W41

| | |
|---|--|
|  Unit weight | 7,85 |
|  color |  blau |
|  piece unit | 100 Pal |
|  accessories | 2 x B-1235 - 3015785, 5 |



Streifen

Strips for slated body / Lame pour clair Voie





LINKS / LEFT / GAUCHE RECHTS / RIGHT / DROITE

CRO 000 40

CRO 000 39

27590302 SRP 330 W1L

27590301 SRP 330 W1

| | |
|---|---|
|  Unit weight | 3,45 |
|  color |  blau |
|  piece unit | 250 Pal |
|  accessories | 4 x B-1235 - 3015785, 5 |



Streifen

Strips for slated body / Lame pour clair Voie





LINKS / LEFT / GAUCHE RECHTS / RIGHT / DROITE

CRO 000 42

CRO 000 41

27590402 SRP 330 W2L

27590401 SRP 330 W2

| | |
|---|--|
|  Unit weight | 3,00 |
|  color |  blau |
|  piece unit | 300 Pal |
|  accessories | 2 x B-1235 - 3015785, 5 |



Streifen

Strips for slated body / Lame pour clair Voie





LINKS / LEFT / GAUCHE RECHTS / RIGHT / DROITE

CRO 000 44

CRO 000 43

27590502 SRP 330 W3L

27590501 SRP 330 W3

| | |
|---|---|
|  Unit weight | 3,80 |
|  color |  blau |
|  piece unit | 250 Pal |
|  accessories | 2 x B-1235 - 3015785, 5 |



Streifen

Strips for slated body / Lame pour clair Voie





LINKS / LEFT / GAUCHE RECHTS / RIGHT / DROITE

CRO 000 46

CRO 000 45

27590602 SRP 330 W4L

27590601 SRP 330 W4

| | |
|---|--|
|  Unit weight | 5,90 |
|  color |  blau |
|  piece unit | 150 Pal |
|  accessories | 2 x B-1235 - 3015785, 5 |



Streifen

Strips for slated body / Lame pour clair Voie





LINKS / LEFT / GAUCHE RECHTS / RIGHT / DROITE

CRO 002 32

CRO 002 31

SRP 236 OBL4

27281301 SRP 236 OB4

| | |
|---|---|
|  Unit weight | 4,60 |
|  color |  blau |
|  piece unit | 200 Pal |
|  accessories | 2 x B-1235 - 3015785, 5 |



Verschleißstück - Streichblech - Vorderteil

Wearing part - Moulboard - Front part / Etrave





LINKS / LEFT / GAUCHE RECHTS / RIGHT / DROITE

CRO 001 32

CRO 001 31

27010702 VRP292-0L VRP290-0L

27010701 VRP292-0 VRP290-0

| | |
|---|--|
|  Unit weight | 1,75 |
|  color |  blau |
|  piece unit | 500 Pal |
|  accessories | 3 x B-1235 - 3015785, 5 |

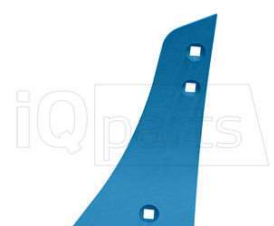

Verschleißstück - Streichblech - Vorderteil

Wearing part - Moulboard - Front part / Etrave





LINKS / LEFT / GAUCHE RECHTS / RIGHT / DROITE

CRO 001 42

CRO 001 41

27040102 VRP 342-0L

27040101 VRP 342-0

| | |
|---|---|
|  Unit weight | 2,00 |
|  color |  blau |
|  piece unit | 500 Pal |
|  accessories | 3 x B-1235 - 3015785, 5 |



Teile passend zu
parts interchangeable
Pièces adaptables pour

RABE

Verschleißstück - Streichblech - Vorderteil

Wearing part - Moulboard - Front part / Etrave

LINKS / LEFT / GAUCHE





CRO 001 34

27080602 VRP230-0L

RECHTS / RIGHT / DROITE

CRO 001 33

27080601 VRP230-0

| | |
|---|--|
|  Unit weight | 1,93 |
|  color |  blau |
|  piece unit | 500 Pal |
|  accessories | 3 x B-1235 - 3015785, 5 |







Verschleißstück - Streichblech - Vorderteil

Wearing part - Moulboard - Front part / Etrave

RECHTS / RIGHT / DROITE

PK1 001 02

2761 0112

| | |
|---|--|
|  Unit weight | 1,77 |
|  color |  rot |
|  piece unit | |
|  accessories | 3 x D-1235 11014D123 |



Verschleißstück - Streichblech - Vorderteil

Wearing part - Moulboard - Front part / Etrave

LINKS / LEFT / GAUCHE





CRO 001 63

VRP 300-0L 2753 0402

RECHTS / RIGHT / DROITE

CRO 001 62

VRP 300-0 2753 0401

| | |
|---|--|
|  Unit weight | 1,70 |
|  color |  blau |
|  piece unit | 500 Pal |
|  accessories | 2 x B-1235 - 3015785, 5 |



Verschleißstück - Streichblech - Vorderteil

Wearing part - Moulboard - Front part / Etrave

LINKS / LEFT / GAUCHE





CRO 001 83

VRP 342-RL 2700 2202

RECHTS / RIGHT / DROITE

CRO 001 82

VRP 342 R 2700 2201

| | |
|---|---|
|  Unit weight | 1,90 |
|  color |  blau |
|  piece unit | 500 Pal |
|  accessories | 3 x B-1235 - 3015785, 5 |



Verschleißstück - Streichblech - Vorderteil

Wearing part - Moulboard - Front part / Etrave

LINKS / LEFT / GAUCHE





CRO 002 02

VRP 350 2751 0502

RECHTS / RIGHT / DROITE

cr0 002 01

VRP 350 2751 0501

| | |
|---|--|
|  Unit weight | 2,20 |
|  color |  blau |
|  piece unit | 400 Pal |
|  accessories | 2 x B-1240 2700 2607, |



Verschleißstück - Streichblech - Vorderteil

Wearing part - Moulboard - Front part / Etrave

LINKS / LEFT / GAUCHE





CRO 002 02V

VRP 350 2751 0502 10MM

RECHTS / RIGHT / DROITE

CRO 002 01V

VRP 350 2751 0501 10MM

| | |
|---|---|
|  Unit weight | 2,50 |
|  color |  blau |
|  piece unit | 400 Pal |
|  accessories | 2 x B-1240 2700 2607, |



Teile passend zu
parts interchangeable
Pièces adaptables pour

REGENT

| | |
|--|-------------------------|
| Anlage Landside / Contre-Sep | |
| LINKS / LEFT / GAUCHE | RECHTS / RIGHT / DROITE |
| CB0 001 49 | CB0 001 48 |
| 227 0114-2 | 160 0711-1 |

| | |
|-------------|------------|
| Unit weight | 5,77 |
| color | grün |
| piece unit | 150 Pal |
| accessories | |



| | |
|--|-------------------------|
| Anlage Landside / Contre-Sep | |
| LINKS / LEFT / GAUCHE | RECHTS / RIGHT / DROITE |
| CB0 001 42 | CB0 001 41 |
| 4320 1152 | 4320 1151 |

| | |
|-------------|------------|
| Unit weight | 4,50 |
| color | grün |
| piece unit | 200 Pal |
| accessories | |



| | |
|--|-------------------------|
| Anlage Landside / Contre-Sep | |
| LINKS / LEFT / GAUCHE | RECHTS / RIGHT / DROITE |
| CB0 000 68 | CB0 000 67 |
| 0371 005-2 | 0371 005-1 |

| | |
|-------------|--|
| Unit weight | 3,50 |
| color | grün |
| piece unit | 300 Pal |
| accessories | 3 x B-1235 - 3015785, 5 1 x A-1660, 545200V |



| | |
|--|-------------------------|
| Anlage Landside / Contre-Sep | |
| LINKS / LEFT / GAUCHE | RECHTS / RIGHT / DROITE |
| CB0 000 72N | CB0 000 71N |
| 160 0111-2 | 160 0111-1 |

| | |
|-------------|---------------------|
| Unit weight | 3,50 |
| color | grün |
| piece unit | 300 Pal |
| accessories | 3 x B-1260, 548250v |



| | |
|--|-------------------------|
| Anlage Landside / Contre-Sep | |
| LINKS / LEFT / GAUCHE | RECHTS / RIGHT / DROITE |
| CB0 000 72N | CB0 000 71N |
| 160 0118-2 | 160 0118-1 |

| | |
|-------------|---------------------|
| Unit weight | 3,50 |
| color | grün |
| piece unit | 300 Pal |
| accessories | 3 x B-1260, 548250v |



| | |
|--|-------------------------|
| Anlage Landside / Contre-Sep | |
| LINKS / LEFT / GAUCHE | RECHTS / RIGHT / DROITE |
| CB0 000 93 | CB0 000 92 |
| 160 0212-2 | 160 0212-1 |

| | |
|-------------|------|
| Unit weight | 6,05 |
| color | grün |
| piece unit | |
| accessories | |



| | |
|--|-------------------------|
| Anlage Landside / Contre-Sep | |
| LINKS / LEFT / GAUCHE | RECHTS / RIGHT / DROITE |
| CB0 000 93 | CB0 000 92 |
| 160 0215-2 | 160 0215-1 |

| | |
|-------------|------|
| Unit weight | 6,05 |
| color | grün |
| piece unit | |
| accessories | |



| | |
|--|-------------------------|
| Anlage Landside / Contre-Sep | |
| LINKS / LEFT / GAUCHE | RECHTS / RIGHT / DROITE |
| CB0 001 19N | CB0 001 18N |
| 160 0611-2 | 160 0611-1 |

| | |
|-------------|---------------------|
| Unit weight | 3,80 |
| color | grün |
| piece unit | 250 Pal |
| accessories | 3 x B-1260, 548250V |



Teile passend zu
parts interchangeable
Pièces adaptables pour

REGENT

Anlage

Landside / Contre-Sep

LINKS / LEFT / GAUCHE





CB0 001 21

160 0711-2

RECHTS / RIGHT / DROITE

CB0 001 20

160 0711-1

| | |
|---|--|
|  Unit weight | 4,00 |
|  color |  grün |
|  piece unit | 150 Pal |
|  accessories | |



Anlage

Landside / Contre-Sep

LINKS / LEFT / GAUCHE





CB0 001 49

160 0711-2

RECHTS / RIGHT / DROITE

CB0 001 48

165 0219-1

| | |
|---|---|
|  Unit weight | 5,77 |
|  color |  grün |
|  piece unit | 150 Pal |
|  accessories | |



Anlage

Landside / Contre-Sep

LINKS / LEFT / GAUCHE





CB0 001 19N

165 0117-2

RECHTS / RIGHT / DROITE

CB0 001 18N

165 0117-1

| | |
|---|--|
|  Unit weight | 3,80 |
|  color |  grün |
|  piece unit | 250 Pal |
|  accessories | 3 x B-1260, 548250V |



Anlage

Landside / Contre-Sep

LINKS / LEFT / GAUCHE





CB0 001 49

165 0219-2

RECHTS / RIGHT / DROITE

CB0 001 48

227 0114-1

| | |
|---|---|
|  Unit weight | 5,77 |
|  color |  grün |
|  piece unit | 150 Pal |
|  accessories | |



Anlage

Landside / Contre-Sep

LINKS / LEFT / GAUCHE





CB0 001 21

165 0219-2

RECHTS / RIGHT / DROITE

CB0 001 20

165 0219-1

| | |
|---|--|
|  Unit weight | 4,00 |
|  color |  grün |
|  piece unit | 150 Pal |
|  accessories | |



Anlage

Landside / Contre-Sep

LINKS / LEFT / GAUCHE





CB0 001 73

495.42.11.2

RECHTS / RIGHT / DROITE

CB0 001 72

495.42.11.1

| | |
|---|---|
|  Unit weight | 6,10 |
|  color |  grün |
|  piece unit | 150 Pal |
|  accessories | |



Anlage

Landside / Contre-Sep

LINKS / LEFT / GAUCHE





CB0 001 75

495.42.13.2

RECHTS / RIGHT / DROITE

CB0 001 74

495.42.13.1

| | |
|---|--|
|  Unit weight | 7,00 |
|  color |  grün |
|  piece unit | 100 Pal |
|  accessories | |



Anlage

Landside / Contre-Sep

LINKS / LEFT / GAUCHE





CB0 001 47

936 40 252

RECHTS / RIGHT / DROITE

CB0 001 46

936 40 251

| | |
|---|---|
|  Unit weight | 6,57 |
|  color |  grün |
|  piece unit | 150 Pal |
|  accessories | |



Teile passend zu
parts interchangeable
Pièces adaptables pour

REGENT

Anlage

Landside / Contre-Sep

LINKS / LEFT / GAUCHE





CB0 001 64

947.60.32 2

RECHTS / RIGHT / DROITE

CB0 001 63

947.60.32 1

| | |
|---|--|
|  Unit weight | 5,50 |
|  color |  grün |
|  piece unit | 150 Pal |
|  accessories | |



Anlage

Landside / Contre-Sep

LINKS / LEFT / GAUCHE





CB0 001 66

947.60.34 2

RECHTS / RIGHT / DROITE

CB0 001 65

947.60.34 1

| | |
|---|---|
|  Unit weight | 6,60 |
|  color |  grün |
|  piece unit | 150 Pal |
|  accessories | |







Anlage

Landside / Contre-Sep

CB0 000 96

RS5 160 0213

| | |
|---|--|
|  Unit weight | 2,20 |
|  color |  grün |
|  piece unit | |
|  accessories | |







Anlage

Landside / Contre-Sep

CB0 000 96

RS5 160 0214

| | |
|---|---|
|  Unit weight | 2,20 |
|  color |  grün |
|  piece unit | |
|  accessories | |







Anlagenschoner

Landside Protection / Protection de Contre-Sep

CB0 001 67

936.40.31

| | |
|---|--|
|  Unit weight | 2,70 |
|  color |  grün |
|  piece unit | 300 Pal |
|  accessories | |







Anlagenschoner

Landside Protection / Protection de Contre-Sep

CB0 001 76

936.42.13

| | |
|---|---|
|  Unit weight | 4,00 |
|  color |  grün |
|  piece unit | 200 Pal |
|  accessories | |







Anlagenschoner

Landside Protection / Protection de Contre-Sep

CB0 001 71

936.42.17

| | |
|---|--|
|  Unit weight | 4,50 |
|  color |  grün |
|  piece unit | 200 Pal |
|  accessories | |







Anlagenschoner

Landside Protection / Protection de Contre-Sep

CB0 001 68

947.60.36

| | |
|---|---|
|  Unit weight | 4,50 |
|  color |  grün |
|  piece unit | 200 Pal |
|  accessories | |



Teile passend zu
parts interchangeable
Pièces adaptables pour

REGENT

Düngereinlegeschar

Skim Point / Soc de Rasette

LINKS / LEFT / GAUCHE





CB0 000 66B

MS / MSL / GS 332 7164

RECHTS / RIGHT / DROITE

CB0 000 65B

MS / MSR / GS 332 7132

| | |
|---|--|
|  Unit weight | 1,30 |
|  color |  grün |
|  piece unit | 800 Pal |
|  accessories | 2 x B-1035 608D1035N |



Düngereinlegeschar

Skim Point / Soc de Rasette

LINKS / LEFT / GAUCHE





CB0 000 66B

MS / MSL / GS 332 7228

RECHTS / RIGHT / DROITE

CB0 000 65B

MS / MSR / GS 332 7196

| | |
|---|---|
|  Unit weight | 1,30 |
|  color |  grün |
|  piece unit | 800 Pal |
|  accessories | 2 x B-1035 608D1035N |







Düngereinlegeschar

Skim Point / Soc de Rasette

RECHTS / RIGHT / DROITE

CB0 000 15

MSR-SR

| | |
|---|--|
|  Unit weight | 1,25 |
|  color |  grün |
|  piece unit | 800 Pal |
|  accessories | 2 x B-1035 608D1035N |







Gleitplatte

Sliding Plate / Talon

CB0 001 43

160 0220

| | |
|---|---|
|  Unit weight | 2,35 |
|  color |  grün |
|  piece unit | 300 Pal |
|  accessories | |







Gleitplatte

Sliding Plate / Talon

CB0 001 43

490 4111

| | |
|---|--|
|  Unit weight | 2,35 |
|  color |  grün |
|  piece unit | 300 Pal |
|  accessories | |







Gleitplatte

Sliding Plate / Talon

CB0 001 70

170.02.21

| | |
|---|---|
|  Unit weight | 3,40 |
|  color |  grün |
|  piece unit | 250 Pal |
|  accessories | |



Meissel - Wechselspitze

Reversible Point / Pointe Reversible

LINKS / LEFT / GAUCHE





CB0 000 18

DWS

RECHTS / RIGHT / DROITE

CB0 000 17

DWS

| | |
|---|--|
|  Unit weight | 1,56 |
|  color |  grün |
|  piece unit | 650 Pal |
|  accessories | 2 x G-1234, 523998V |



Meissel - Wechselspitze

Reversible Point / Pointe Reversible

LINKS / LEFT / GAUCHE





CB0 000 18V

DWSV-L 15MM

RECHTS / RIGHT / DROITE

CB0 000 17V

DWSV-R 15MM

| | |
|---|---|
|  Unit weight | 1,86 |
|  color |  grün |
|  piece unit | 500 Pal |
|  accessories | 2 x G-1234, 523998V |

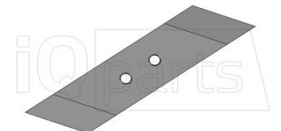

Teile passend zu
parts interchangeable
Pièces adaptables pour

REGENT

Meissel - Wechselspitze

Reversible Point / Pointe Reversible

LINKS / LEFT / GAUCHE





CB0 000 18VD

DWSV-LD 15MM Diamant

RECHTS / RIGHT / DROITE

CB0 000 17VD

DWSV-RD 15MM Diamant

| | |
|---|--|
|  Unit weight | 1,86 |
|  color |  grün |
|  piece unit | 500 Pal |
|  accessories | 2 x G-1234, 523998V |

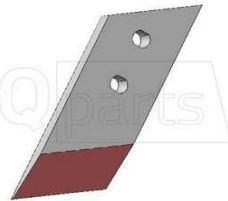

Mollblech -Streichblech

Mouldboard / Versoir

LINKS / LEFT / GAUCHE





CB0 001 05

MK 226 0214-2

RECHTS / RIGHT / DROITE

CB0 001 04

MK 226 0214-1

| | |
|---|---|
|  Unit weight | 13,20 |
|  color |  grün |
|  piece unit | 50 Pal |
|  accessories | 7 x B-1035 608D1035N |



Mollblech -Streichblech

Mouldboard / Versoir

LINKS / LEFT / GAUCHE





CB0 001 07

MK 227 0311-2

RECHTS / RIGHT / DROITE

CB0 001 06

MK 227 0311-1

| | |
|---|--|
|  Unit weight | 14,70 |
|  color |  grün |
|  piece unit | 50 Pal |
|  accessories | 6 x B-1035 608D1035N |



Mollblech -Streichblech

Mouldboard / Versoir

LINKS / LEFT / GAUCHE





CB0 001 05

MU352 435 0114-2

RECHTS / RIGHT / DROITE

CB0 001 04

MU352 435 0114-1

| | |
|---|---|
|  Unit weight | 13,20 |
|  color |  grün |
|  piece unit | 50 Pal |
|  accessories | 7 x B-1035 608D1035N |



Scharblatt

Wing / Aileron

LINKS / LEFT / GAUCHE





CB0 001 55

DG774.5L 332 1384

RECHTS / RIGHT / DROITE

CB0 001 54

DG774.5R 332 1380

| | |
|---|--|
|  Unit weight | 4,32 |
|  color |  grün |
|  piece unit | 220 unit |
|  accessories | 3 x C-1235, 523997V |



Schare

Share / Soc

LINKS / LEFT / GAUCHE





CB0 000 20

3318228 DU30S (DU28, DU29)

RECHTS / RIGHT / DROITE

CB0 000 19

3318212 DU30S (DU28, DU29)

| | |
|---|---|
|  Unit weight | 4,50 |
|  color |  grün |
|  piece unit | 150 Pal |
|  accessories | 2 x G-1234, 523998V |



Schare

Share / Soc

LINKS / LEFT / GAUCHE





CB0 000 28

3318388 DU435S (DU433 3318356)

RECHTS / RIGHT / DROITE

CB0 000 27

3318372 DU435S (DU433-3318340)

| | |
|---|--|
|  Unit weight | 4,65 |
|  color |  grün |
|  piece unit | 150 Pal |
|  accessories | 4 x G-1234, 523998V |



Schare

Share / Soc

LINKS / LEFT / GAUCHE





CB0 000 48

DU 28 S

RECHTS / RIGHT / DROITE

CB0 000 47

DU 28 S

| | |
|---|---|
|  Unit weight | 3,74 |
|  color |  grün |
|  piece unit | 150 Pal |
|  accessories | 2 x G-1234, 523998V |



Teile passend zu
parts interchangeable
Pièces adaptables pour

REGENT

| Schare Share / Soc | |
|---|-------------------------|
| LINKS / LEFT / GAUCHE | RECHTS / RIGHT / DROITE |
| CB0 000 22 | CB0 000 21 |
| DU33S 331 8292 | DU33S 331 8276 |
| Unit weight 3,60 | |
| color ■ grün | |
| piece 150 | |
| unit Pal | |
| accessories 3 x G-1234, 523998V | |



| Schare Share / Soc | |
|---|-------------------------|
| LINKS / LEFT / GAUCHE | RECHTS / RIGHT / DROITE |
| CB0 000 24 | CB0 000 23 |
| DU35S 331 8276 (DU33) | DU35S 3318292 (DU33) |
| Unit weight 4,70 | |
| color ■ grün | |
| piece 150 | |
| unit Pal | |
| accessories 3 x G-1234, 523998V | |



| Schare Share / Soc | |
|---|-------------------------|
| LINKS / LEFT / GAUCHE | RECHTS / RIGHT / DROITE |
| CB0 000 44 | CB0 000 43 |
| DU40S 331 8324 | DU40S 331 8308 |
| Unit weight 5,05 | |
| color ■ grün | |
| piece 150 | |
| unit Pal | |
| accessories 3 x G-1234, 523998V | |



| Schare Share / Soc | |
|---|-------------------------|
| LINKS / LEFT / GAUCHE | RECHTS / RIGHT / DROITE |
| CB0 000 26 | CB0 000 25 |
| DU433SL 331 8356 | DU433SR 331 8340 |
| Unit weight 4,70 | |
| color ■ grün | |
| piece 150 | |
| unit Pal | |
| accessories 4 x G-1234, 523998V | |



| Schare Share / Soc | |
|---|-------------------------|
| LINKS / LEFT / GAUCHE | RECHTS / RIGHT / DROITE |
| CB0 000 30 | CB0 000 29 |
| DU440S 331 8420 | DU440S 331 8404 |
| Unit weight 4,80 | |
| color ■ grün | |
| piece 150 | |
| unit Pal | |
| accessories 4 x G-1234, 523998V | |



| Schare - Wechselspitzschare Share for rev. Point / Soc pour pointe reversilbe | |
|--|-------------------------|
| LINKS / LEFT / GAUCHE | RECHTS / RIGHT / DROITE |
| CB0 001 62 | CB0 001 61 |
| 3318674 SW 672.6L | 3318673 SW672.6R |
| Unit weight 6,20 | |
| color ■ grün | |
| piece 150 | |
| unit Pal | |
| accessories 4 x G-1234, 523998V | |



| Schare - Wechselspitzschare Share for rev. Point / Soc pour pointe reversilbe | |
|--|-------------------------|
| LINKS / LEFT / GAUCHE | RECHTS / RIGHT / DROITE |
| CB0 001 60 | CB0 001 59 |
| 3321296 DW442SL | 3321295 DW442SR |
| Unit weight 5,40 | |
| color ■ grün | |
| piece 150 | |
| unit Pal | |
| accessories 4 x G-1234, 523998V | |



| Schare - Wechselspitzschare Share for rev. Point / Soc pour pointe reversilbe | |
|--|-------------------------|
| LINKS / LEFT / GAUCHE | RECHTS / RIGHT / DROITE |
| CB0 000 34 | CB0 000 33 |
| DW35S 332 1196 | DW35S 332 1180 |
| Unit weight 4,50 | |
| color ■ grün | |
| piece 150 | |
| unit Pal | |
| accessories 3 x G-1234, 523998V | |



Teile passend zu
parts interchangeable
Pièces adaptables pour

REGENT

Schare - Wechselspitzenschare

Share for rev. Point / Soc pour pointe reversilbe

LINKS / LEFT / GAUCHE





CB0 000 36

DW40S 332 1228

RECHTS / RIGHT / DROITE

CB0 000 35

DW40S 332 1212

| | |
|---|--|
|  Unit weight | 4,60 |
|  color |  grün |
|  piece unit | 150 Pal |
|  accessories | 3 x G-1234, 523998V |



Schare - Wechselspitzenschare

Share for rev. Point / Soc pour pointe reversilbe

LINKS / LEFT / GAUCHE





CB0 000 40

DW435S 332 1260

RECHTS / RIGHT / DROITE

CB0 000 39

DW435S 332 1244

| | |
|---|---|
|  Unit weight | 4,60 |
|  color |  grün |
|  piece unit | 300 Pal |
|  accessories | 4 x G-1234, 523998V |



Schare - Wechselspitzenschare

Share for rev. Point / Soc pour pointe reversilbe

LINKS / LEFT / GAUCHE





CB0 000 42

DW440S 332 1292

RECHTS / RIGHT / DROITE

CB0 000 41

DW440S 332 1276

| | |
|---|--|
|  Unit weight | 4,75 |
|  color |  grün |
|  piece unit | 150 Pal |
|  accessories | 4 x G-1234, 523998V |



Scharspitze

Share point / Nez de Soc





LINKS / LEFT / GAUCHE

CB0 001 53

DGS 770L 332 1374

RECHTS / RIGHT / DROITE

CB0 001 52

| | |
|---|---|
|  Unit weight | 2,75 |
|  color |  grün |
|  piece unit | 300 Pal |
|  accessories | 2 x C-1235, 523997V |

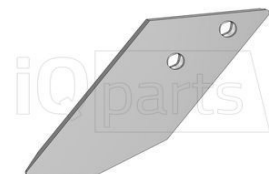





Streichschiene

Tailpress / Rallonge de Versoir

CB0 001 58

MU54-65

| | |
|---|--|
|  Unit weight | 1,30 |
|  color |  grün |
|  piece unit | 500 Pal |
|  accessories | |



Verschleißstück - Streichblech - Vorderteil

Wearing part - Moulboard - Front part / Etrave

LINKS / LEFT / GAUCHE





CB0 001 09

MKL 226 0126-2

RECHTS / RIGHT / DROITE

CB0 001 08

MK 226 0126-1

| | |
|---|---|
|  Unit weight | 2,40 |
|  color |  grün |
|  piece unit | 400 Pal |
|  accessories | 3 x B-1035 608D1035N |



Teile passend zu
parts interchangeable
Pièces adaptables pour





Ross-Roudnice

Schare

Share / Soc

CV0 060 11

9YM, CV006036, RE ZETOR

| | |
|---|---|
|  Unit weight | 5,25 |
|  color |  schwarz |
|  piece unit | 150 Pal |
|  accessories | 3 x B-1240 2700 2607, |







Schare

Share / Soc

RECHTS / RIGHT / DROITE

CB0 000 45

AC07 P

| | |
|---|--|
|  Unit weight | 6,65 |
|  color |  schwarz |
|  piece unit | 150 Pal |
|  accessories | 3 x B-1240 2700 2607, |







Schare

Share / Soc

RECHTS / RIGHT / DROITE

CB0 001 30

AC07 Profil

| | |
|---|---|
|  Unit weight | 5,60 |
|  color |  schwarz |
|  piece unit | 150 Pal |
|  accessories | 3 x B-1240 2700 2607, |







Schare

Share / Soc

LINKS / LEFT / GAUCHE

CV0 060 13

P-30 RL

| | |
|---|--|
|  Unit weight | 4,00 |
|  color |  schwarz |
|  piece unit | 250 Pal |
|  accessories | 2 x B-1240 2700 2607, |

RECHTS / RIGHT / DROITE

CV0 060 12

P-30-R



Teile passend zu
parts interchangeable
Pièces adaptables pour

Rumptstad

Scharblatt Wing / Aileron

RECHTS / RIGHT / DROITE

CR1 000 24

18106 RUMPTSTAD

| | |
|---------------|------------|
| Unit weight | 4,35 |
| color | schwarz |
| piece unit | 250 Pal |
| accessories | |

Schare Share / Soc

LINKS / LEFT / GAUCHE

CR1 000 02

1209 RUMPTSTAD

| | |
|---------------|------------|
| Unit weight | 6,00 |
| color | schwarz |
| piece unit | 200 Pal |
| accessories | |



Scharspitze

Share point / Nez de Soc

LINKS / LEFT / GAUCHE

CR1 000 21

18101 RUMPTSTAD

RECHTS / RIGHT / DROITE

CR1 000 20

18102 RUMPTSTAD

| | |
|---------------|------------|
| Unit weight | 2,75 |
| color | schwarz |
| piece unit | 450 Pal |
| accessories | |



Teile passend zu
parts interchangeable
Pièces adaptables pour

SUKOV

Meissel - Wechselspitze

Reversible Point / Pointe Reversible

LINKS / LEFT / GAUCHE

CS3 000 04

C10102-013-50

RECHTS / RIGHT / DROITE

CS3 000 03

C10102-013-00

| | |
|---------------|------------|
| Unit weight | 1,30 |
| color | grün |
| piece unit | 500 Pal |
| accessories | |

Meissel - Wechselspitze

Reversible Point / Pointe Reversible

LINKS / LEFT / GAUCHE

CS3 000 04V

C10102-013-50V

RECHTS / RIGHT / DROITE

CS3 000 03V

C10102-013-00V

| | |
|---------------|------------|
| Unit weight | 1,63 |
| color | grün |
| piece unit | 500 Pal |
| accessories | |

Teile passend zu
parts interchangeable
Pièces adaptables pour

UNIA

Meissel - Wechselspitze

Reversible Point / Pointe Reversible

LINKS / LEFT / GAUCHE





CU0 000 06

1067 28/0000

RECHTS / RIGHT / DROITE

CU0 000 05

1067 27 0000

| | |
|---|---|
|  Unit weight | 1,75 |
|  color |  rot |
|  piece unit | 500 Pal |
|  accessories | 2 x G-1240, 523732V |



Meissel - Wechselspitze

Reversible Point / Pointe Reversible

LINKS / LEFT / GAUCHE





CU0 000 10

1150 72 2010

RECHTS / RIGHT / DROITE

CU0 000 09

1150 71 2010

| | |
|---|--|
|  Unit weight | 1,75 |
|  color |  rot |
|  piece unit | 500 Pal |
|  accessories | 2 x O-1240 294503511 |



Schare - Wechselspitzenschare

Share for rev. Point / Soc pour pointe reversilbe

LINKS / LEFT / GAUCHE





CU0 000 08

1067 92100 - 19,5MM

RECHTS / RIGHT / DROITE

CU0 000 07

1067 91100 - 19,5MM

| | |
|---|---|
|  Unit weight | 6,40 |
|  color |  rot |
|  piece unit | 150 Pal |
|  accessories | |



Teile passend zu
parts interchangeable
Pièces adaptables pour

Ventzky

Anlage

Landside / Contre-Sep

LINKS / LEFT / GAUCHE





CV1 000 10

03832-92

RECHTS / RIGHT / DROITE

CV1 000 09

03832-91

| | |
|---|--|
|  Unit weight | 3,67 |
|  color | ■ rot |
|  piece unit | 300 Pal |
|  accessories | 3 x A-1650-M16 x 50 mit sf |







Anlage

Landside / Contre-Sep

RECHTS / RIGHT / DROITE

CV1 000 11

03841-25

| | |
|---|--|
|  Unit weight | 3,00 |
|  color | ■ rot |
|  piece unit | 300 Pal |
|  accessories | 2 x A-1650-M16 x 50 mit sf |







Schare

Share / Soc

RECHTS / RIGHT / DROITE

CV1 000 18

VX 26

| | |
|---|--|
|  Unit weight | 3,00 |
|  color | ■ rot |
|  piece unit | 150 Pal |
|  accessories | 2 x D-1240, 546200V |



Teile passend zu
parts interchangeable
Pièces adaptables pour

Vogel & Noot

| | | | | |
|---|--|--|--|---------------|
| LK2 001 11AH <i>WXM40 C-PLUS hardface</i> | | Anlage Landside / Contre-Sep | | WST430 |
| NIO 240 72 <i>024072 N15G</i> | | | | |

| | |
|-------------|-----------------------|
| Unit weight | 5,10 |
| color | rot |
| piece unit | |
| accessories | 3 x H-1439, LK000009V |

| | |
|-------------|---|
| Unit weight | 5,05 |
| color | rot |
| piece unit | 200 Pal |
| accessories | 1 x A-1650-M16 x 50 mit sf 1 x M-1240 M12x40, 50 |



| | | |
|--|--------------------------------------|-------------------------------------|
| Anlage Landside / Contre-Sep | | W275; W300; WSU300 |
| LINKS / LEFT / GAUCHE | RECHTS / RIGHT / DROITE | |
| P50 002 05 <i>P5000205</i> | P50 001 05 <i>P5000105</i> | |

| | |
|-------------|-------------------------|
| Unit weight | 4,85 |
| color | rot |
| piece unit | 200 Pal |
| accessories | 2 x B-1235 - 3015785, 5 |



| | | |
|--|--|--|
| Anlage Landside / Contre-Sep | | M300; M350; W275; W300; |
| RECHTS / RIGHT / DROITE | | |
| P50 003 01 <i>P5000301</i> | | |

| | |
|-------------|-------------------------|
| Unit weight | 2,55 |
| color | rot |
| piece unit | 400 Pal |
| accessories | 2 x B-1235 - 3015785, 5 |

| | | |
|--|---------------------------------------|--|
| Anlage Landside / Contre-Sep | | |
| LINKS / LEFT / GAUCHE | RECHTS / RIGHT / DROITE | |
| P89 035 01P <i>P8903501P</i> | P89 034 01P <i>P8903401</i> | |

| | |
|-------------|---|
| Unit weight | 3,35 |
| color | rot |
| piece unit | 300 Pal |
| accessories | 6 x G-1240, 523732V 1 x I-1675 PK800010 M: |



| | | |
|--|---------------------------------------|--|
| Anlage Landside / Contre-Sep | | |
| LINKS / LEFT / GAUCHE | RECHTS / RIGHT / DROITE | |
| P89 037 01P <i>P8903701P</i> | P89 036 01P <i>P8903601</i> | |

| | |
|-------------|---|
| Unit weight | 5,40 |
| color | rot |
| piece unit | 200 Pal |
| accessories | 6 x G-1240, 523732V 1 x I-1675 PK800010 M: |



| | | |
|--|---------------------------------------|--|
| Anlage Landside / Contre-Sep | | |
| LINKS / LEFT / GAUCHE | RECHTS / RIGHT / DROITE | |
| PK8 035 01P <i>PK803501</i> | PK8 034 01P <i>PK803401</i> | |

| | |
|-------------|---|
| Unit weight | 4,10 |
| color | rot |
| piece unit | 250 Pal |
| accessories | 4 x G-1240, 523732V 1 x I-1675 PK800010 M: |



| | | |
|--|--|--|
| Anlage Landside / Contre-Sep | | |
| LINKS / LEFT / GAUCHE | RECHTS / RIGHT / DROITE | |
| PK8 140 03P <i>PK814003P</i> | PK8 130 03P <i>PK813003P</i> | |

| | |
|-------------|---------------------|
| Unit weight | 2,55 |
| color | rot |
| piece unit | 400 Pal |
| accessories | 2 x G-1240, 523732V |



Teile passend zu
parts interchangeable
Pièces adaptables pour





Vogel & Noot

Anlage

Landside / Contre-Sep

PR1 034 01

PR103401 M430 RE

| | |
|---|--|
|  Unit weight | 8,60 |
|  color | ■ rot |
|  piece unit | Pal |
|  accessories | 3 x D-1240, 546200V 1 x D-1640, 548351V |







Anlage

Landside / Contre-Sep

PR7 030 02P

PR7 030 02P

| | |
|---|--|
|  Unit weight | 4,80 |
|  color | ■ rot |
|  piece unit | 200 Pal |
|  accessories | 3 x F-1640 PK800013 M |







Anlage

Landside / Contre-Sep

PR7 030 01P

PR703001P

| | |
|---|--|
|  Unit weight | 1,10 |
|  color | ■ rot |
|  piece unit | 900 Pal |
|  accessories | 2 x G-1240, 523732V |







Anlage

Landside / Contre-Sep

PR7 030 02DP

PR703002DP Diamant

| | |
|---|--|
|  Unit weight | 4,90 |
|  color | ■ rot |
|  piece unit | 200 Pal |
|  accessories | 3 x F-1640 PK800013 M |







Anlage

Landside / Contre-Sep

PR7 030 03P

PR703003P PR733P

| | |
|---|--|
|  Unit weight | 2,75 |
|  color | ■ rot |
|  piece unit | 200 Pal |
|  accessories | 2 x F-1640 PK800013 M |







Anlagenkeil

Landside Tip / Nez de contre-sep

NIO 240 04

024004 N15G

| | |
|---|--|
|  Unit weight | 1,00 |
|  color | ■ rot |
|  piece unit | 1 000 Pal |
|  accessories | 2 x M-1240 M12x40, 5C |



Anlagensech

Sword Landside / Ailerons Coutre

WST430

LINKS / LEFT / GAUCHE





NIO 262 41

026241

RECHTS / RIGHT / DROITE

NIO 262 40

026240

| | |
|---|--|
|  Unit weight | 1,90 |
|  color | ■ rot |
|  piece unit | 200 Pal |
|  accessories | 2 x M-1240 M12x40, 50 |



Anlagensech

Sword Landside / Ailerons Coutre

MPK400;

MPK430;

LINKS / LEFT / GAUCHE





PK2 020 01

PK2 020 01

RECHTS / RIGHT / DROITE

PK2 019 01

PK2 019 01

| | |
|---|--|
|  Unit weight | 3,73 |
|  color | ■ rot |
|  piece unit | 250 Pal |
|  accessories | 5 x G-1240, 523732V |



Teile passend zu
parts interchangeable
Pièces adaptables pour

Vogel & Noot

Anlagensech

Sword Landside / Ailerons Coutre

LINKS / LEFT / GAUCHE





PK2 016 01P

PK201601P

RECHTS / RIGHT / DROITE

PK2 015 01P

PK201501P

| | |
|---|--|
|  Unit weight | 3,50 |
|  color | ■ rot |
|  piece unit | 250 Pal |
|  accessories | 5 x G-1240, 523732V |



Anlagensech

Sword Landside / Ailerons Coutre

LINKS / LEFT / GAUCHE





PK2 018 01P

PK201801P

RECHTS / RIGHT / DROITE

PK2 017 01P

PK201701P

| | |
|---|--|
|  Unit weight | 3,50 |
|  color | ■ rot |
|  piece unit | 250 Pal |
|  accessories | 5 x G-1240, 523732V |







BUCHSE

Bush /

847 060

38X30X40MM,FORM 3 (LC800024)

| | |
|---|------|
|  Unit weight | 0,13 |
|  color | |
|  piece unit | |
|  accessories | |

Düngereinlegeblech

Skimmer Board / Versoirs de Rasette

LINKS / LEFT / GAUCHE





LZ1 052 02P

LZ105202P

RECHTS / RIGHT / DROITE

LZ1 051 02P

LZ105102P

| | |
|---|--|
|  Unit weight | 3,00 |
|  color | ■ rot |
|  piece unit | 400 Pal |
|  accessories | 2 x D-1235 11014D123 |



Düngereinlegeblech

Skimmer Board / Versoirs de Rasette

LINKS / LEFT / GAUCHE





LZ1 367 02P

LZ136702P

RECHTS / RIGHT / DROITE

LZ1 366 02P

LZ136602P

| | |
|---|--|
|  Unit weight | 1,70 |
|  color | ■ rot |
|  piece unit | 400 Pal |
|  accessories | 2 x D-1030, 523742V |



Düngereinlegeblech

Skimmer Board / Versoirs de Rasette

LINKS / LEFT / GAUCHE





LZ1 377 02P

LZ137702P

RECHTS / RIGHT / DROITE

LZ1 376 02P

LZ137602P

| | |
|---|--|
|  Unit weight | 2,65 |
|  color | ■ rot |
|  piece unit | 400 Pal |
|  accessories | 2 x D-1030, 523742V |



Düngereinlegeblech

Skimmer Board / Versoirs de Rasette

LINKS / LEFT / GAUCHE





P82 043 01

P82 043 01

RECHTS / RIGHT / DROITE

P82 042 01

P82 042 01

| | |
|---|--|
|  Unit weight | 2,00 |
|  color | ■ rot |
|  piece unit | Pal |
|  accessories | 2 x D-1235 11014D123 |





Düngereinlegeblech

Skimmer Board / Versoirs de Rasette

RECHTS / RIGHT / DROITE

P82 045 01

P82 045 01

| | |
|---|--|
|  Unit weight | 2,80 |
|  color | ■ rot |
|  piece unit | 400 Pal |
|  accessories | 2 x D-1235 11014D123 |



Teile passend zu
parts interchangeable
Pièces adaptables pour

Vogel & Noot

Düngereinlegeblech

Skimmer Board / Versoirs de Rasette

LINKS / LEFT / GAUCHE





PA3 055 02P

PA3 05502P

RECHTS / RIGHT / DROITE

PA3 054 02P

PA305402P

| | |
|---|---|
|  Unit weight | 2,50 |
|  color |  rot |
|  piece unit | 400 Pal |
|  accessories | 2 x D-1030, 523742V |







Düngereinlegeblech

Skimmer Board / Versoirs de Rasette

RECHTS / RIGHT / DROITE

PF3 241 01

PF324101 PA305402

| | |
|---|--|
|  Unit weight | 3,41 |
|  color |  rot |
|  piece unit | 300 Pal |
|  accessories | 2 x D-1030, 523742V |



Düngereinlegeblech

Skimmer Board / Versoirs de Rasette

LINKS / LEFT / GAUCHE





Z23 357 02

Z2335702 RH67-90 Li

RECHTS / RIGHT / DROITE

Z23 356 02

Z2335602 RH67-90 re

| | |
|---|---|
|  Unit weight | 2,50 |
|  color |  rot |
|  piece unit | |
|  accessories | |



Düngereinlegeschar

Skim Point / Soc de Rasette

LINKS / LEFT / GAUCHE





P66 070 04BP

P66 070 04BP

RECHTS / RIGHT / DROITE

P66 070 01BP

P66 070 01BP

| | |
|---|--|
|  Unit weight | 1,22 |
|  color |  rot |
|  piece unit | 800 Pal |
|  accessories | 2 x D-1235 11014D123 |

Düngereinlegeschar

Skim Point / Soc de Rasette

LINKS / LEFT / GAUCHE





LZ1 357 01DP

PA305402 Diamant

RECHTS / RIGHT / DROITE

LZ1 356 01DP

PA305401 Diamant

| | |
|---|---|
|  Unit weight | 2,10 |
|  color |  rot |
|  piece unit | 500 Pal |
|  accessories | 2 x G-1240, 523732V |



Düngereinlegeschar

Skim Point / Soc de Rasette

LINKS / LEFT / GAUCHE





LZ1 357 01P

PA305501 PE323201

RECHTS / RIGHT / DROITE

LZ1 356 01P

921 02 148 0

| | |
|---|--|
|  Unit weight | 1,70 |
|  color |  rot |
|  piece unit | 500 Pal |
|  accessories | 2 x G-1240, 523732V |



Düngereinlegeschar

Skim Point / Soc de Rasette

LINKS / LEFT / GAUCHE





Z23 357 01

Z2335701

RECHTS / RIGHT / DROITE

Z23 356 01

Z2335601





| | |
|---|---|
|  Unit weight | 1,46 |
|  color |  rot |
|  piece unit | |
|  accessories | |

Gleitplatte

Sliding Plate / Talon

N10 262 48

026248

| | |
|---|--|
|  Unit weight | 5,40 |
|  color |  rot |
|  piece unit | 200 Pal |
|  accessories | 2 x A-1650-M16 x 50 mit sf |







Teile passend zu
parts interchangeable
Pièces adaptables pour

Vogel & Noot

Gleitplatte Sliding Plate / Talon

P58 009 01P

P5800901P





| | |
|---|-------------------------|
|  Unit weight | 4,98 |
|  color | rot |
|  piece unit | 200 Pal |
|  accessories | 4 x B-1235 - 3015785, 5 |



Gleitplatte Sliding Plate / Talon

P58 011 01P

P5801101P



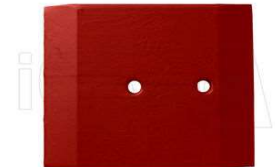

| | |
|---|---------------------|
|  Unit weight | 3,15 |
|  color | rot |
|  piece unit | 300 Pal |
|  accessories | 2 x G-1240, 523732V |



Gleitplatte Sliding Plate / Talon

PR7 030 04P

PR7 030 04P





| | |
|---|-----------------------|
|  Unit weight | 2,75 |
|  color | rot |
|  piece unit | 300 Pal |
|  accessories | 2 x F-1640 PK800013 M |



Grindel Leg / Âge

PE2 000 18

RH67





| | |
|---|-------|
|  Unit weight | 10,55 |
|  color | |
|  piece unit | |
|  accessories | |



Grindel Leg / Âge

PE4 000 16

RH72





| | |
|---|-------|
|  Unit weight | 11,55 |
|  color | rot |
|  piece unit | |
|  accessories | |



Grindel Leg / Âge

PP0 000 16

RH72





| | |
|---|-------|
|  Unit weight | 12,50 |
|  color | |
|  piece unit | |
|  accessories | |



Grindel Leg / Âge

C22 000 18

RH72 (RH67) NON-STOP SCI





| | |
|---|-------|
|  Unit weight | 11,93 |
|  color | |
|  piece unit | |
|  accessories | |



Grindel Leg / Âge

PG0 000 22

RH76

| | |
|---|-------|
|  Unit weight | 16,86 |
|  color | |
|  piece unit | |
|  accessories | |



Teile passend zu
parts interchangeable
Pièces adaptables pour

Vogel & Noot

Grindel
Leg / Âge

C24 000 22

RH76 "XS"

 Unit weight 19,63

 color

 piece unit

 accessories



Grindel
Leg / Âge

PG5 610 16

RH76 (SEMI-AUTO)

 Unit weight 15,25

 color

 piece unit

 accessories



Grindel
Leg / Âge

PF3 000 16

RH78

 Unit weight 12,43

 color

 piece unit

 accessories



Grindel
Leg / Âge

PF3 000 18

RH78

 Unit weight 12,50

 color

 piece unit

 accessories

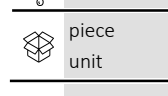

Grindel
Leg / Âge

PG0 000 16

RH82

 Unit weight 18,39

 color

 piece unit

 accessories



Grindel
Leg / Âge

PP0 000 20

RH82

 Unit weight 16,66

 color

 piece unit

 accessories



Grindel
Leg / Âge

C24 000 16

RH82 "XS"

 Unit weight 21,40

 color

 piece unit

 accessories



Grindel
Leg / Âge

PG5 610 18

RH82 (SEMI-AUTO)

 Unit weight 18,31

 color

 piece unit

 accessories



Teile passend zu
parts interchangeable
Pièces adaptables pour

Vogel & Noot

Grindel Leg / Âge

C15 000 20

RH82 XM-Leichte Ausf.

Unit weight 13,60

color

piece unit

accessories



Grindel Leg / Âge

PP0 000 22

RH86

Unit weight 17,68

color

piece unit

accessories

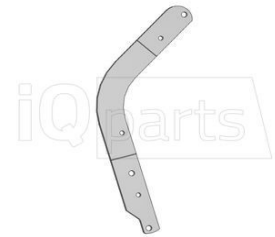

Meissel - Wechselspitze

Reversible Point / Pointe Reversible

LINKS / LEFT / GAUCHE

N10 241 05

024105 N15G

RECHTS / RIGHT / DROITE

N10 241 04

024104 N15G

Unit weight 1,28

color ■ rot

piece unit 500 Pal

accessories 2 x O-1235 M12x35 Mu



Meissel - Wechselspitze

Reversible Point / Pointe Reversible

LINKS / LEFT / GAUCHE

LK2 011 02V

65x15

RECHTS / RIGHT / DROITE

LK2 011 01V

65 x 15

Unit weight 1,70

color ■ rot

piece unit 500 Pal

accessories 2 x H-1240, LK100009V



Meissel - Wechselspitze

Reversible Point / Pointe Reversible

LINKS / LEFT / GAUCHE

PK0 011 02

PK001102 PK0L li

RECHTS / RIGHT / DROITE

PK0 011 01

PK001101 PK0 re

**M430; U10;
U13; U15;**

Unit weight 1,60

color ■ rot

piece unit 850 Pal

accessories 2 x D-1235 11014D123



Meissel - Wechselspitze

Reversible Point / Pointe Reversible

LINKS / LEFT / GAUCHE

PK8 011 02V

PK8 01102v 15mm

RECHTS / RIGHT / DROITE

PK8 011 01V

PK8 01101V 15mm

Unit weight 1,70

color ■ rot

piece unit 600 Pal

accessories 2 x H-1240, LK100009V



Meissel - Wechselspitze

Reversible Point / Pointe Reversible

LINKS / LEFT / GAUCHE

PK8 011 02DP

PK8 20mm Diamant

RECHTS / RIGHT / DROITE

PK8 011 01DP

PK8 20mm Diamant

Unit weight 1,85

color ■ rot

piece unit 500 Pal

accessories 2 x G-1240, 523732V



Meissel - Wechselspitze

Reversible Point / Pointe Reversible

LINKS / LEFT / GAUCHE

PK8 011 02P

PK801102 PK8L 12mm

RECHTS / RIGHT / DROITE

PK8 011 01P

PK801101 PK8 12mm

Unit weight 1,30

color ■ rot

piece unit 600 Pal

accessories 2 x G-1240, 523732V



Teile passend zu
parts interchangeable
Pièces adaptables pour

Vogel & Noot

Meissel - Wechselspitze

Reversible Point / Pointe Reversible





LINKS / LEFT / GAUCHE
PK8 011 02AP

PK801102AP 15,5mm

RECHTS / RIGHT / DROITE

PK8 011 01AP

PK8 R 15,5mm

| | |
|---|--|
|  Unit weight | 1,70 |
|  color | ■ rot |
|  piece unit | 500 Pal |
|  accessories | 2 x H-1240, LK100009V |



Meissel - Wechselspitze

Reversible Point / Pointe Reversible





LK2 011 02A

WXHM

RECHTS / RIGHT / DROITE

LK2 011 01A

WXHM

| | |
|---|--|
|  Unit weight | 1,70 |
|  color | ■ rot |
|  piece unit | |
|  accessories | |







Meissel - Wechselspitze

Reversible Point / Pointe Reversible

RECHTS / RIGHT / DROITE

LK2 011 01DA

WXHM Diamant

| | |
|---|--|
|  Unit weight | 1,90 |
|  color | ■ rot |
|  piece unit | 600 |
|  accessories | 2 x H-1240, LK100009V |

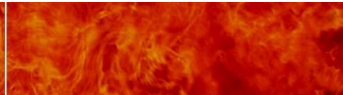

MESSER

KNIFE /

WL430

LINKS / LEFT / GAUCHE





LZ2 062 01

LZ2 062 01

RECHTS / RIGHT / DROITE

LZ2 061 01

LZ2 061 01

| | |
|---|--|
|  Unit weight | 6,26 |
|  color | ■ rot |
|  piece unit | Pal |
|  accessories | 2 x G-1240, 523732V |



Mollblech -Streichblech

Mouldboard / Versoir

MPK400/430





LINKS / LEFT / GAUCHE
PR4 002 01K

MPK 400 / 430 li

RECHTS / RIGHT / DROITE

PR4 001 01K

MPK 400 / 430 re

| | |
|---|--|
|  Unit weight | 15,00 |
|  color | ■ rot |
|  piece unit | 50 Pal |
|  accessories | 7 x D-1235 11014D123 |

Mollblech -Streichblech

Mouldboard / Versoir





LINKS / LEFT / GAUCHE
PK1 002 01K

NL460

RECHTS / RIGHT / DROITE

PK1 001 01K

NL 460

| | |
|---|-------|
|  Unit weight | 20,38 |
|  color | |
|  piece unit | |
|  accessories | |

Mollblech -Streichblech

Mouldboard / Versoir

W275





LINKS / LEFT / GAUCHE
P50 002 01

P5000201 W275 li

RECHTS / RIGHT / DROITE

P50 001 01

P5000101 W275 re

| | |
|---|--|
|  Unit weight | 1,40 |
|  color | ■ rot |
|  piece unit | 700 Pal |
|  accessories | 5 x B-1035 608D1035N |



Mollblech -Streichblech

Mouldboard / Versoir

WS275





LINKS / LEFT / GAUCHE
P51 016 01

P5101601 WS275 li

RECHTS / RIGHT / DROITE

P51 015 01

P5101501 WS275 re

| | |
|---|--|
|  Unit weight | 0,95 |
|  color | ■ rot |
|  piece unit | 1 000 Pal |
|  accessories | 5 x B-1035 608D1035N |



Teile passend zu
parts interchangeable
Pièces adaptables pour

Vogel & Noot

| | | |
|--------------------------------|-------------------------|-------------|
| Mollblech -Streichblech | | W300 |
| Mouldboard / Versoir | | |
| LINKS / LEFT / GAUCHE | RECHTS / RIGHT / DROITE | |
| P52 002 01 | P52 001 01 | |
| <i>P5200201 W300</i> | <i>P5200101 W300 re</i> | |

| | |
|-------------|--|
| Unit weight | 8,80 |
| color | ■ rot |
| piece unit | 50 Pal |
| accessories | 5 x B-1035 608D1035N |



| | | |
|--------------------------------|--|-------------|
| Mollblech -Streichblech | | M300 |
| Mouldboard / Versoir | | |
| RECHTS / RIGHT / DROITE | | |
| P54 001 01 | | |
| <i>P5400101 M 300 re</i> | | |

| | |
|-------------|--|
| Unit weight | 7,75 |
| color | ■ rot |
| piece unit | 150 Pal |
| accessories | 4 x B-1235 - 3015785, 5 |



| | | |
|--------------------------------|--|---------------|
| Mollblech -Streichblech | | WSU350 |
| Mouldboard / Versoir | | |
| RECHTS / RIGHT / DROITE | | |
| P59 001 02 | | |
| <i>P5900102 WSU350 re</i> | | |

| | |
|-------------|--|
| Unit weight | 15,60 |
| color | ■ rot |
| piece unit | Pal |
| accessories | 6 x B-1035 608D1035N |

| | | |
|--------------------------------|--------------------------|--------------|
| Mollblech -Streichblech | | WS400 |
| Mouldboard / Versoir | | |
| LINKS / LEFT / GAUCHE | RECHTS / RIGHT / DROITE | |
| PK0 002 01B | PK0 001 01B | |
| <i>PK000201 WS400 li</i> | <i>PK000101 WS400 re</i> | |

| | |
|-------------|--|
| Unit weight | 18,25 |
| color | ■ rot |
| piece unit | 50 Pal |
| accessories | 6 x D-1240, 546200V |



| | | |
|--------------------------------|---------------------------|--|
| Mollblech -Streichblech | | |
| Mouldboard / Versoir | | |
| LINKS / LEFT / GAUCHE | RECHTS / RIGHT / DROITE | |
| PK3 002 02BP | PK3 001 02BP | |
| <i>PK300202BP UN350L</i> | <i>HST 1120 CV0 00037</i> | |

| | |
|-------------|--|
| Unit weight | 11,50 |
| color | ■ rot |
| piece unit | 50 Pal |
| accessories | 6 x D-1235 11014D123 |

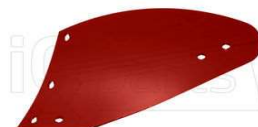

| | | |
|--------------------------------|---------------------------|--|
| Mollblech -Streichblech | | |
| Mouldboard / Versoir | | |
| LINKS / LEFT / GAUCHE | RECHTS / RIGHT / DROITE | |
| PK4 002 02BP | PK4 001 02BP | |
| <i>PK400202BP UN400L</i> | <i>HST 1160 CV0 00039</i> | |

| | |
|-------------|--|
| Unit weight | 13,86 |
| color | ■ rot |
| piece unit | 50 Pal |
| accessories | 6 x D-1235 11014D123 |

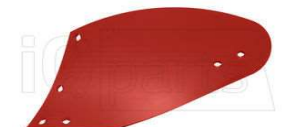

| | | |
|--------------------------------|-------------------------|--|
| Mollblech -Streichblech | | |
| Mouldboard / Versoir | | |
| LINKS / LEFT / GAUCHE | RECHTS / RIGHT / DROITE | |
| PK5 002 02BP | PK5 001 02BP | |
| <i>PK500202 UN430li</i> | <i>PK500102BP UN430</i> | |

| | |
|-------------|--|
| Unit weight | 18,50 |
| color | ■ rot |
| piece unit | 50 Pal |
| accessories | 6 x D-1235 11014D123 |



| | | |
|--------------------------------|--------------------------|--------------------|
| Mollblech -Streichblech | | WS13; WS350 |
| Mouldboard / Versoir | | |
| LINKS / LEFT / GAUCHE | RECHTS / RIGHT / DROITE | |
| PK6 002 01B | PK6 001 01B | |
| <i>PK600201 WS350 li</i> | <i>PK600101 WS350 re</i> | |

| | |
|-------------|---|
| Unit weight | 15,80 |
| color | ■ rot |
| piece unit | 50 Pal |
| accessories | 4 x D-1035, 523801V 4 x D-1235 11014D123 |







Teile passend zu
parts interchangeable
Pièces adaptables pour

Vogel & Noot

Mollblech -Streichblech Mouldboard / Versoir





| LINKS / LEFT / GAUCHE | RECHTS / RIGHT / DROITE |
|--------------------------|-------------------------|
| PK7 002 01BP | PK7 001 01BP |
| <i>PK700201BP WY350L</i> | <i>1903559z</i> |

| | |
|---|---|
|  Unit weight | 16,50 |
|  color |  rot |
|  piece unit | 50 Pal |
|  accessories | 4 x D-1035, 523801V 4 x D-1235 11014D123 |



Mollblech -Streichblech Mouldboard / Versoir





| LINKS / LEFT / GAUCHE | RECHTS / RIGHT / DROITE |
|--------------------------|-------------------------|
| PK8 002 01BP | PK8 001 01BP |
| <i>PK800201BP WY400L</i> | <i>PK800101BP WY400</i> |

| | |
|---|--|
|  Unit weight | 20,58 |
|  color |  rot |
|  piece unit | 50 Pal |
|  accessories | 4 x D-1035, 523801V 4 x D-1235 11014D123 |



Mollblech -Streichblech Mouldboard / Versoir

| LINKS / LEFT / GAUCHE | RECHTS / RIGHT / DROITE |
|--------------------------|---------------------------|
| PK8 002 09P | PK8 001 09P |
| <i>PK800209 WY400 li</i> | <i>PK800109P WY 400 R</i> |





| | |
|---|---|
|  Unit weight | 19,63 |
|  color |  rot |
|  piece unit | Pal |
|  accessories | 4 x D-1235 11014D123 3 x D-1035, 523801V |



Mollblech -Streichblech Mouldboard / Versoir

M350

| LINKS / LEFT / GAUCHE | RECHTS / RIGHT / DROITE |
|-------------------------|-------------------------|
| PK9 002 01B | PK9 001 01B |
| <i>PK900201 M350 li</i> | <i>PK900101 M350 re</i> |



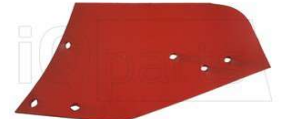

| | |
|---|--|
|  Unit weight | 2,16 |
|  color |  rot |
|  piece unit | 450 Pal |
|  accessories | 6 x D-1235 11014D123 |



Mollblech -Streichblech Mouldboard / Versoir

UL430

| LINKS / LEFT / GAUCHE | RECHTS / RIGHT / DROITE |
|--------------------------|--------------------------|
| PR2 002 01B | PR2 001 01B |
| <i>PR200201 UL430 li</i> | <i>PR200101 UL430 re</i> |





| | |
|---|---|
|  Unit weight | 18,89 |
|  color |  rot |
|  piece unit | 50 Pal |
|  accessories | 6 x D-1235 11014D123 |



Mollblech -Streichblech Mouldboard / Versoir

WL430

| LINKS / LEFT / GAUCHE | RECHTS / RIGHT / DROITE |
|---------------------------|--------------------------|
| PR8 002 01B | PR8 001 01B |
| <i>PR800201 WL430L li</i> | <i>PR800101 WL430 re</i> |





| | |
|---|--|
|  Unit weight | 23,83 |
|  color |  rot |
|  piece unit | 50 Pal |
|  accessories | 6 x D-1235 11014D123 |



Mollblech -Streichblech Mouldboard / Versoir

U10; UN300





| LINKS / LEFT / GAUCHE | RECHTS / RIGHT / DROITE |
|-----------------------|--------------------------|
| PK2 002 02B | PK2 001 02B |
| <i>UN300L</i> | <i>HST 1080 CV000035</i> |

| | |
|---|---|
|  Unit weight | 9,50 |
|  color |  rot |
|  piece unit | 100 Pal |
|  accessories | 6 x D-1235 11014D123 |



Mollblech -Streichblech Mouldboard / Versoir

| LINKS / LEFT / GAUCHE | RECHTS / RIGHT / DROITE |
|-----------------------|-------------------------|
| PR7 000 02P | PR7 000 01P |
| <i>WX400</i> | <i>WX400</i> |

| | |
|---|--|
|  Unit weight | 21,05 |
|  color |  rot |
|  piece unit | 40 Pal |
|  accessories | 8 x D-1235 11014D123 |

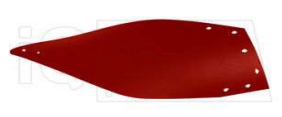

Teile passend zu
parts interchangeable
Pièces adaptables pour

Vogel & Noot

| | | |
|--------------------------------|-------------------------|---------------|
| Mollblech -Streichblech | | WXL430 |
| Mouldboard / Versoir | | |
| LINKS / LEFT / GAUCHE | RECHTS / RIGHT / DROITE | |
| PR6 000 02 | PR6 000 01 | |
| <i>WXL 430</i> | <i>WXL 430</i> | |

| | |
|-------------|--|
| Unit weight | 26,00 |
| color | ■ rot |
| piece unit | Pal |
| accessories | 12 x D-1235 11014D12 |



| | | |
|-----------------------|-------------------------|---------------|
| Scharblatt | | WST430 |
| Wing / Aileron | | |
| LINKS / LEFT / GAUCHE | RECHTS / RIGHT / DROITE | |
| NIO 241 21 | NIO 241 22 | |
| <i>024121 NH6G</i> | <i>024122 NH6G</i> | |

| | |
|-------------|--|
| Unit weight | 4,60 |
| color | ■ rot |
| piece unit | 200 Pal |
| accessories | 3 x D-1235 11014D123 |



| | | |
|------------------------------|-------------------------|---------------|
| Schare | | WST430 |
| Share / Soc | | |
| LINKS / LEFT / GAUCHE | RECHTS / RIGHT / DROITE | |
| CN1 056 00 | CN1 055 00 | |
| <i>CN105600 WST 430 L NI</i> | <i>WST 430 NI</i> | |

| | |
|-------------|--|
| Unit weight | 6,60 |
| color | ■ rot |
| piece unit | 150 Pal |
| accessories | 5 x D-1235 11014D123 |

| | | |
|-------------------------|--|--|
| Schare | | |
| Share / Soc | | |
| RECHTS / RIGHT / DROITE | | |
| CV0 000 61 | | |
| <i>KMF257 C RE</i> | | |

| | |
|-------------|--|
| Unit weight | 3,30 |
| color | ■ rot |
| piece unit | 150 Pal |
| accessories | 2 x D-1235 11014D123 |



| | | |
|-----------------------------------|-----------------------------------|--|
| Schare | | |
| Share / Soc | | |
| LINKS / LEFT / GAUCHE | RECHTS / RIGHT / DROITE | |
| LK2 016 00A | LK2 015 00A | |
| <i>LK201600A WSM 40 L3 C-plus</i> | <i>LK201500A WSM 40 R3 C-plus</i> | |

| | |
|-------------|--|
| Unit weight | 7,70 |
| color | ■ rot |
| piece unit | 150 Pal |
| accessories | |



| | | |
|-----------------------------------|-----------------------------------|--|
| Schare | | |
| Share / Soc | | |
| LINKS / LEFT / GAUCHE | RECHTS / RIGHT / DROITE | |
| LK2 018 00A | LK2 017 00A | |
| <i>LK201800A WSM 43 L3 C-plus</i> | <i>LK201700A WSM 43 R3 C-plus</i> | |

| | |
|-------------|--|
| Unit weight | 8,00 |
| color | ■ rot |
| piece unit | 150 Pal |
| accessories | |



| | | |
|---------------------------|---------------------------|---------------|
| Schare | | WS 275 |
| Share / Soc | | |
| LINKS / LEFT / GAUCHE | RECHTS / RIGHT / DROITE | |
| P51 002 05 | P51 001 05 | |
| <i>P5100205 WS 275 li</i> | <i>P5100103 WS 275 re</i> | |

| | |
|-------------|--|
| Unit weight | 2,60 |
| color | ■ rot |
| piece unit | 400 Pal |
| accessories | 2 x D-1235 11014D123 |



| | | |
|---------------------------|--|----------------|
| Schare | | WSU 350 |
| Share / Soc | | |
| RECHTS / RIGHT / DROITE | | |
| P59 001 01 | | |
| <i>P5900101 WSU350 re</i> | | |

| | |
|-------------|--|
| Unit weight | 3,80 |
| color | ■ rot |
| piece unit | 250 Pal |
| accessories | 2 x D-1235 11014D123 |







Teile passend zu
parts interchangeable
Pièces adaptables pour

Vogel & Noot

Schare U10; U13; U15





| Share / Soc | |
|--------------------------|--------------------------|
| LINKS / LEFT / GAUCHE | RECHTS / RIGHT / DROITE |
| P90 031 01 | P90 030 01 |
| <i>P9003101 U1300 li</i> | <i>P9003001 U1300 re</i> |

| | |
|---|--|
|  Unit weight | 5,00 |
|  color | ■ rot |
|  piece unit | 250 Pal |
|  accessories | 3 x D-1235 11014D123 |



Schare





| Share / Soc | |
|------------------------|--------------------------------|
| LINKS / LEFT / GAUCHE | RECHTS / RIGHT / DROITE |
| P91 031 01P | P91 030 01P |
| <i>P9103101P U1500</i> | <i>P9103001P U1500 (U1300)</i> |

| | |
|---|--|
|  Unit weight | 5,40 |
|  color | ■ rot |
|  piece unit | 150 Pal |
|  accessories | 3 x D-1235 11014D123 |



Schare





| Share / Soc | |
|------------------------|-------------------------|
| LINKS / LEFT / GAUCHE | RECHTS / RIGHT / DROITE |
| P93 002 01P | P93 001 01P |
| <i>P9300201P WY25L</i> | <i>925 21 000</i> |

| | |
|---|--|
|  Unit weight | 4,05 |
|  color | ■ rot |
|  piece unit | 150 Pal |
|  accessories | 3 x D-1235 11014D123 |



Schare





| Share / Soc | |
|------------------------|-------------------------|
| LINKS / LEFT / GAUCHE | RECHTS / RIGHT / DROITE |
| P93 031 02P | P93 030 02P |
| <i>P9303102 WY3500</i> | <i>P9303002 WY3500</i> |

| | |
|---|--|
|  Unit weight | 5,00 |
|  color | ■ rot |
|  piece unit | 150 Pal |
|  accessories | 3 x D-1235 11014D123 |



Schare Y25





| Share / Soc | |
|---------------------------|---------------------------|
| LINKS / LEFT / GAUCHE | RECHTS / RIGHT / DROITE |
| P93 031 03 | P93 030 03 |
| <i>P9303103 WY4000 li</i> | <i>P9303003 WY4000 re</i> |

| | |
|---|--|
|  Unit weight | 5,05 |
|  color | ■ rot |
|  piece unit | 200 Pal |
|  accessories | 3 x D-1235 11014D123 |



Schare





| Share / Soc | |
|-----------------------------------|--|
| RECHTS / RIGHT / DROITE | |
| P95 001 01 | |
| <i>P9500101 W35 re (KMF) 256E</i> | |

| | |
|---|--|
|  Unit weight | 3,75 |
|  color | ■ rot |
|  piece unit | 150 Pal |
|  accessories | 3 x D-1235 11014D123 |



Schare





| Share / Soc | |
|----------------------------|----------------------------------|
| LINKS / LEFT / GAUCHE | RECHTS / RIGHT / DROITE |
| PK0 000 04AP | PK0 000 03AP |
| <i>PK000004AP WS350 L3</i> | <i>PK000003AP WS350 R3 (30°)</i> |

| | |
|---|--|
|  Unit weight | 5,05 |
|  color | ■ rot |
|  piece unit | 150 Pal |
|  accessories | 3 x H-1439, LK000009V |



Schare

| Share / Soc | |
|--------------------------|--------------------------|
| LINKS / LEFT / GAUCHE | RECHTS / RIGHT / DROITE |
| PK0 000 06AP | PK0 000 05AP |
| <i>PK000006AP WS400L</i> | <i>PK000005AP WS 400</i> |

| | |
|---|--|
|  Unit weight | 5,20 |
|  color | ■ rot |
|  piece unit | 150 Pal |
|  accessories | 3 x H-1439, LK000009V |



Teile passend zu
parts interchangeable
Pièces adaptables pour

Vogel & Noot

Schare

Share / Soc





LINKS / LEFT / GAUCHE
PK0 000 08AP

PK000008AP WS430L

RECHTS / RIGHT / DROITE

PK0 000 07AP

PK000007AP WS430

| | |
|---|---|
|  Unit weight | 5,40 |
|  color |  rot |
|  piece unit | 150 Pal |
|  accessories | 3 x H-1439, LK000009V |



Schare

Share / Soc





LINKS / LEFT / GAUCHE
PK0 006 00A

PK000600 WS 400 L3

RECHTS / RIGHT / DROITE

PK0 005 00A

PK000500 WS 400 R3

| | |
|---|--|
|  Unit weight | 6,20 |
|  color |  rot |
|  piece unit | 150 Pal |
|  accessories | |



Schare

Share / Soc





LINKS / LEFT / GAUCHE
PK0 008 00A

PK000800 WS 430 L3

RECHTS / RIGHT / DROITE

PK0 007 00A

PK000700 WS 430 R3

| | |
|---|---|
|  Unit weight | 6,40 |
|  color |  rot |
|  piece unit | 150 Pal |
|  accessories | |



Schare

Share / Soc





LINKS / LEFT / GAUCHE
PK3 002 01AP

PK300201AP UN350L

RECHTS / RIGHT / DROITE

PK3 001 01AP

PK300101AP UN350

| | |
|---|--|
|  Unit weight | 5,00 |
|  color |  rot |
|  piece unit | 150 Pal |
|  accessories | 3 x H-1439, LK000009V |



Schare

Share / Soc





LINKS / LEFT / GAUCHE
PK4 002 01AP

PK400201AP UN400L

RECHTS / RIGHT / DROITE

PK4 001 01AP

PK400101AP UN400 R3

| | |
|---|---|
|  Unit weight | 5,40 |
|  color |  rot |
|  piece unit | 150 Pal |
|  accessories | 3 x H-1439, LK000009V |



Schare

Share / Soc





LINKS / LEFT / GAUCHE
PK5 002 01AP

PK500201AP UN430 L3

RECHTS / RIGHT / DROITE

PK5 001 01AP

PK500101AP UN430 R3

| | |
|---|--|
|  Unit weight | 5,45 |
|  color |  rot |
|  piece unit | 150 Pal |
|  accessories | 3 x H-1439, LK000009V |



Schare

Share / Soc





LINKS / LEFT / GAUCHE
PK7 014 00A

PK701400 WSM 40 L3

RECHTS / RIGHT / DROITE

PK7 013 00A

PK701300 WSM 40 R3

| | |
|---|---|
|  Unit weight | 7,05 |
|  color |  rot |
|  piece unit | 200 Pal |
|  accessories | |



Schare

Share / Soc





LINKS / LEFT / GAUCHE
PK8 014 00A

PK801400 WSM 43 L3

RECHTS / RIGHT / DROITE

PK8 013 00A

PK801300 WSM 43 R3

| | |
|---|--|
|  Unit weight | 7,25 |
|  color |  rot |
|  piece unit | |
|  accessories | |



Teile passend zu
parts interchangeable
Pièces adaptables pour

Vogel & Noot

| | | |
|---|---|-------------|
| Schare Share / Soc | | M350 |
| LINKS / LEFT / GAUCHE PK9 000 02 <i>PK900002 M350 li</i> | RECHTS / RIGHT / DROITE PK9 000 01 <i>PK900001 M350 re</i> | |

| | |
|-------------|--|
| Unit weight | 4,05 |
| color | ■ rot |
| piece unit | 250 Pal |
| accessories | 3 x D-1235 11014D123 |



| | | |
|---|---|-------------|
| Schare Share / Soc | | M350 |
| LINKS / LEFT / GAUCHE PK9 000 04 <i>PK900004 M400 li</i> | RECHTS / RIGHT / DROITE PK9 000 03 <i>PK900003 M400 re</i> | |

| | |
|-------------|--|
| Unit weight | 4,35 |
| color | ■ rot |
| piece unit | 250 Pal |
| accessories | 3 x D-1235 11014D123 |



| | | |
|---|---|--------------------------------|
| Schare Share / Soc | | UN350; UN400; UN430 |
| LINKS / LEFT / GAUCHE PK4 002 00 <i>UN400 li</i> | RECHTS / RIGHT / DROITE PK4 001 00 <i>UN400 re</i> | |

| | |
|-------------|--|
| Unit weight | 6,00 |
| color | ■ rot |
| piece unit | Pal |
| accessories | 3 x G-1439 M14 x 39 M |



| | | |
|---|---|-------------------------------|
| Schare Share / Soc | | M430; UN400; UN430 |
| LINKS / LEFT / GAUCHE PK5 002 00 <i>UN430 li</i> | RECHTS / RIGHT / DROITE PK5 001 00 <i>UN430 re</i> | |

| | |
|-------------|--|
| Unit weight | 6,20 |
| color | ■ rot |
| piece unit | Pal |
| accessories | 3 x G-1439 M14 x 39 M |



| | |
|--|--|
| Schare Share / Soc | |
| LINKS / LEFT / GAUCHE LK2 008 00A <i>WS 430 L3 C-plus</i> | RECHTS / RIGHT / DROITE LK2 007 00A <i>WS 430 R3 C-plus</i> |

| | |
|-------------|--|
| Unit weight | 8,00 |
| color | ■ rot |
| piece unit | |
| accessories | |



| | |
|---|--|
| Schare Share / Soc | |
| LINKS / LEFT / GAUCHE PK0 000 02AP <i>WS300L</i> | RECHTS / RIGHT / DROITE PK0 000 01AP |

| | |
|-------------|--|
| Unit weight | 4,15 |
| color | ■ rot |
| piece unit | 150 Pal |
| accessories | |



| | |
|--|--|
| Schare Share / Soc | |
| LINKS / LEFT / GAUCHE LK2 000 04A <i>WS350 L C-plus</i> | RECHTS / RIGHT / DROITE LK2 000 03A <i>LK200003A WS 350 R3 C-plus</i> |

| | |
|-------------|--|
| Unit weight | 5,70 |
| color | ■ rot |
| piece unit | |
| accessories | 3 x H-1439, LK000009V |



| | |
|---|---|
| Schare Share / Soc | |
| LINKS / LEFT / GAUCHE LK2 000 06AP <i>WS400 L C-PLUS</i> | RECHTS / RIGHT / DROITE LK2 000 05AP <i>WS400 R C-PLUS</i> |

| | |
|-------------|--|
| Unit weight | 6,35 |
| color | ■ rot |
| piece unit | |
| accessories | 3 x H-1439, LK000009V |



Teile passend zu
parts interchangeable
Pièces adaptables pour

Vogel & Noot

Schare

Share / Soc

LINKS / LEFT / GAUCHE





LK2 000 08AHP

WS430 L C-PLUS

RECHTS / RIGHT / DROITE

LK2 000 07AHP

WS430 C-PLUS Hardface

| | |
|---|---|
|  Unit weight | 7,00 |
|  color |  rot |
|  piece unit | 150 Pal |
|  accessories | 3 x H-1439, LK000009V |

Schare

Share / Soc

LINKS / LEFT / GAUCHE





LK2 000 08AP

WS430 L C-PLUS

RECHTS / RIGHT / DROITE

LK2 000 07AP

WS430 R C-PLUS

| | |
|---|--|
|  Unit weight | 6,70 |
|  color |  rot |
|  piece unit | 150 Pal |
|  accessories | 3 x H-1439, LK000009V |







Schare

Share / Soc

RECHTS / RIGHT / DROITE

LK2 001 07DA

WSM 43 R C-plus Diamant

| | |
|---|---|
|  Unit weight | 6,40 |
|  color |  rot |
|  piece unit | 150 Pal |
|  accessories | 3 x H-1439, LK000009V |

Schare

Share / Soc

LINKS / LEFT / GAUCHE





LK2 001 06D

WSM40 C-PLUS Diamant

RECHTS / RIGHT / DROITE

LK2 001 05D

WSM40 re

| | |
|---|--|
|  Unit weight | 6,60 |
|  color |  rot |
|  piece unit | 150 Pal |
|  accessories | 3 x G-1439 M14 x 39 M |



**WL430(plus);
WY400(plus)**

Schare

Share / Soc

LINKS / LEFT / GAUCHE





LK2 001 06DA

WSM40 L C-plus Diamant

RECHTS / RIGHT / DROITE

LK2 001 05DA

WSM40 R C-plus Diamant

| | |
|---|---|
|  Unit weight | 6,60 |
|  color |  rot |
|  piece unit | 150 Pal |
|  accessories | 3 x H-1439, LK000009V |



Schare - Wechselspitzenschare

Share for rev. Point / Soc pour pointe reversilbe

LINKS / LEFT / GAUCHE





CN1 000 56

CN100056 WST 430 L NI

RECHTS / RIGHT / DROITE

CN1 000 55

WST 430 NI

| | |
|---|--|
|  Unit weight | 6,30 |
|  color |  rot |
|  piece unit | 150 Pal |
|  accessories | 5 x D-1235 11014D123 |



WST430

Schare - Wechselspitzenschare





Share for rev. Point / Soc pour pointe reversilbe

RECHTS / RIGHT / DROITE

P90 034 03

P90 03403 U1300 M re

U10; U13; U15

| | |
|---|---|
|  Unit weight | 5,25 |
|  color |  rot |
|  piece unit | 200 Pal |
|  accessories | 3 x D-1235 11014D123 |



Schare - Wechselspitzenschare

Share for rev. Point / Soc pour pointe reversilbe

LINKS / LEFT / GAUCHE





P91 035 03

P9103503 U1500M li

RECHTS / RIGHT / DROITE

P91 034 03

P9103403 U1500M re

| | |
|---|--|
|  Unit weight | 5,50 |
|  color |  rot |
|  piece unit | 200 Pal |
|  accessories | 3 x D-1235 11014D123 |



U13; U15

Teile passend zu
parts interchangeable
Pièces adaptables pour

Vogel & Noot

Schare - Wechselspitzschare

Share for rev. Point / Soc pour pointe reversilbe

LINKS / LEFT / GAUCHE

P93 031 06

P9303106 WY4000M li

RECHTS / RIGHT / DROITE

P93 030 06

P9303006 WY4000M re

| | |
|-------------|----------------------|
| Unit weight | 5,55 |
| color | rot |
| piece unit | 200 Pal |
| accessories | 3 x D-1235 11014D123 |



Schare - Wechselspitzschare

Share for rev. Point / Soc pour pointe reversilbe

LINKS / LEFT / GAUCHE

PK3 014 01AP

PK301401AP UNM35L

RECHTS / RIGHT / DROITE

PK3 013 01AP

PK301301AP UNM35 R3

| | |
|-------------|-----------------------|
| Unit weight | 5,05 |
| color | rot |
| piece unit | 150 Pal |
| accessories | 3 x H-1439, LK000009V |



Schare - Wechselspitzschare

Share for rev. Point / Soc pour pointe reversilbe

LINKS / LEFT / GAUCHE

PK4 014 01AH

PK4 01401 AH UNM40L hardface

RECHTS / RIGHT / DROITE

PK4 013 01AH

PK4 01301 AH UNM40 hardface

| | |
|-------------|-----------------------|
| Unit weight | 5,60 |
| color | rot |
| piece unit | 200 Pal |
| accessories | 3 x H-1439, LK000009V |



Schare - Wechselspitzschare

Share for rev. Point / Soc pour pointe reversilbe

LINKS / LEFT / GAUCHE

PK4 014 01AP

PK401401AP UNM40 L3

RECHTS / RIGHT / DROITE

PK4 013 01AP

PK401301AP UNM40 R3

| | |
|-------------|-----------------------|
| Unit weight | 5,60 |
| color | rot |
| piece unit | 150 Pal |
| accessories | 3 x H-1439, LK000009V |



Schare - Wechselspitzschare

Share for rev. Point / Soc pour pointe reversilbe

LINKS / LEFT / GAUCHE

PK5 014 01AP

PK501401AP UNM43L

RECHTS / RIGHT / DROITE

PK5 013 01AP

PK501301AP UNM43

| | |
|-------------|-----------------------|
| Unit weight | 5,90 |
| color | rot |
| piece unit | 150 Pal |
| accessories | 3 x H-1439, LK000009V |



Schare - Wechselspitzschare

Share for rev. Point / Soc pour pointe reversilbe

LINKS / LEFT / GAUCHE

PK6 014 01AP

PK601401AP WSM35 L3

RECHTS / RIGHT / DROITE

PK6 013 01AP

PK601301AP WSM35 R3

| | |
|-------------|-----------------------|
| Unit weight | 5,10 |
| color | rot |
| piece unit | 150 Pal |
| accessories | 3 x H-1439, LK000009V |



Schare - Wechselspitzschare

Share for rev. Point / Soc pour pointe reversilbe

LINKS / LEFT / GAUCHE

PK7 014 01AP

PK701401AP WSM40 L3

RECHTS / RIGHT / DROITE

PK7 013 01AP

PK701301AP WSM40 re

| | |
|-------------|-----------------------|
| Unit weight | 5,30 |
| color | rot |
| piece unit | 150 Pal |
| accessories | 3 x H-1439, LK000009V |



Schare - Wechselspitzschare

Share for rev. Point / Soc pour pointe reversilbe

LINKS / LEFT / GAUCHE

PK8 014 01AP

PK801401AP WSM43o L3

RECHTS / RIGHT / DROITE

PK8 013 01AP

PK801301AP WSM430 R3

| | |
|-------------|-----------------------|
| Unit weight | 6,10 |
| color | rot |
| piece unit | 150 Pal |
| accessories | 3 x H-1439, LK000009V |



Teile passend zu
parts interchangeable
Pièces adaptables pour

Vogel & Noot

Schare - Wechselspitzschare

Share for rev. Point / Soc pour pointe reversilbe

LINKS / LEFT / GAUCHE





LK2 001 06AH

WSM 40 C-PLUS Hardface

RECHTS / RIGHT / DROITE

LK2 001 05AH

WSM 40 C-PLUS Hardface

| | |
|---|---|
|  Unit weight | 6,90 |
|  color |  rot |
|  piece unit | |
|  accessories | |







Schare - Wechselspitzschare

Share for rev. Point / Soc pour pointe reversilbe

LINKS / LEFT / GAUCHE

LK2 001 08AH

WSM 43 C-PLUS Hardface

| | |
|---|--|
|  Unit weight | 7,20 |
|  color |  rot |
|  piece unit | |
|  accessories | |

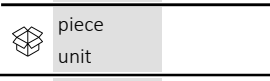

Schare - Wechselspitzschare

Share for rev. Point / Soc pour pointe reversilbe

LINKS / LEFT / GAUCHE





LK2 001 04AP

WSM35 L C-PLUS

RECHTS / RIGHT / DROITE

LK2 001 03AP

WSM35 R C-PLUS

| | |
|---|---|
|  Unit weight | 5,20 |
|  color |  rot |
|  piece unit | |
|  accessories | 3 x H-1439, LK000009V |



Schare - Wechselspitzschare

Share for rev. Point / Soc pour pointe reversilbe

LINKS / LEFT / GAUCHE





LK2 001 06AP

WSM40 L C-PLUS

RECHTS / RIGHT / DROITE

LK2 001 05AP

WSM40 R C-PLUS

| | |
|---|--|
|  Unit weight | 6,20 |
|  color |  rot |
|  piece unit | 150 |
|  accessories | 3 x H-1439, LK000009V |



Schare - Wechselspitzschare

Share for rev. Point / Soc pour pointe reversilbe

LINKS / LEFT / GAUCHE





LK2 001 08AP

WSM43 L C-PLUS

RECHTS / RIGHT / DROITE

LK2 001 07AP

WSM43 R C-PLUS

| | |
|---|---|
|  Unit weight | 6,40 |
|  color |  rot |
|  piece unit | 150 |
|  accessories | 3 x H-1439, LK000009V |



Schare - Wechselspitzschare

Share for rev. Point / Soc pour pointe reversilbe

LINKS / LEFT / GAUCHE





LK2 001 22AP

WXH40 C-PLUS

RECHTS / RIGHT / DROITE

LK2 001 21AP

WXH40 C-PLUS

| | |
|---|--|
|  Unit weight | 7,50 |
|  color |  rot |
|  piece unit | 150 |
|  accessories | 3 x H-1439, LK000009V |



Schare - Wechselspitzschare

Share for rev. Point / Soc pour pointe reversilbe

LINKS / LEFT / GAUCHE





LK2 001 22AH

WXHM40 C-Plus Hardface

RECHTS / RIGHT / DROITE

LK2 001 21AH

WXHM40 C-PLUS

| | |
|---|---|
|  Unit weight | 8,23 |
|  color |  rot |
|  piece unit | |
|  accessories | |



Schare - Wechselspitzschare

Share for rev. Point / Soc pour pointe reversilbe

LINKS / LEFT / GAUCHE





LK2 001 24AP

WXHM43 C-PLUS

RECHTS / RIGHT / DROITE

LK2 001 23AP

WXHM42 C-PLUS

| | |
|---|--|
|  Unit weight | 8,67 |
|  color |  rot |
|  piece unit | 150 |
|  accessories | 3 x H-1439, LK000009V |



Teile passend zu
parts interchangeable
Pièces adaptables pour

Vogel & Noot

Schare - Wechselspitzenschare

Share for rev. Point / Soc pour pointe reversilbe

LINKS / LEFT / GAUCHE





LK2 001 24AH

WXHM43 C-PLUS Hardface

RECHTS / RIGHT / DROITE

LK2 001 23AH

WXHM43 C-PLUS Hardface

| | |
|---|---|
|  Unit weight | 9,00 |
|  color |  rot |
|  piece unit | |
|  accessories | |



Schare - Wechselspitzenschare

Share for rev. Point / Soc pour pointe reversilbe

LINKS / LEFT / GAUCHE





LK2 001 12AP

WXM40 L C-PLUS

RECHTS / RIGHT / DROITE

LK2 001 11AP

WXM40 R C-PLUS

| | |
|---|--|
|  Unit weight | 5,10 |
|  color |  rot |
|  piece unit | 150 Pal |
|  accessories | 3 x H-1439, LK000009V |



Schare - Wechselspitzenschare

Share for rev. Point / Soc pour pointe reversilbe

LINKS / LEFT / GAUCHE





LK2 001 14AP

WXM43 C-PLUS

RECHTS / RIGHT / DROITE

LK2 001 13AP

WXM43 R C-PLUS

| | |
|---|---|
|  Unit weight | 6,40 |
|  color |  rot |
|  piece unit | 150 Pal |
|  accessories | 3 x H-1439, LK000009V |



Scharspitze

Share point / Nez de Soc

WST430

LINKS / LEFT / GAUCHE





NI2 006 79

200679 SH15G

RECHTS / RIGHT / DROITE

NI2 006 78

200678 SH15G

| | |
|---|--|
|  Unit weight | 2,30 |
|  color |  rot |
|  piece unit | 400 Pal |
|  accessories | 3 x D-1235 11014D123 |







Scheibe

Disc / Disque

P61 038 03

P6103803





| | |
|---|---|
|  Unit weight | 3,25 |
|  color |  rot |
|  piece unit | |
|  accessories | |

Scheibe

Disc / Disque

PP0 237 E1

PP0237E1 DM500

| | |
|---|--|
|  Unit weight | 6,75 |
|  color |  schwarz |
|  piece unit | |
|  accessories | |







Schraube

Screw / Boulon

PF3 000 01

Scherschraube M16x85

| | |
|---|---|
|  Unit weight | 0,16 |
|  color |  rot |
|  piece unit | Pal |
|  accessories | |

Streichschiene

Tailpress / Rallonge de Versoir

LINKS / LEFT / GAUCHE





LZ1 052 01P

LZ1 052 01P

RECHTS / RIGHT / DROITE

LZ1 051 01P

LZ1 051 01P

| | |
|---|--|
|  Unit weight | 2,51 |
|  color |  rot |
|  piece unit | |
|  accessories | |



Teile passend zu
parts interchangeable
Pièces adaptables pour

Vogel & Noot





Streichschiene

Tailpress / Rallonge de Versoir

M375; W300;
WS275;

PK7 001 02

PK700102 WY350

| | |
|---|---|
|  Unit weight | 1,06 |
|  color |  rot |
|  piece unit | 950 Pal |
|  accessories | |



Streichschiene





Tailpress / Rallonge de Versoir

LINKS / LEFT / GAUCHE
PK8 002 02P

PK800202P

RECHTS / RIGHT / DROITE
PK8 001 02P

PK800102P

| | |
|---|--|
|  Unit weight | 1,40 |
|  color |  rot |
|  piece unit | 500 Pal |
|  accessories | |



Streifen

Strips for slated body / lame pour clair Voie





WST 430

LINKS / LEFT / GAUCHE
NIO 241 25

024125 II

RECHTS / RIGHT / DROITE
NIO 241 26

024126 II

| | |
|---|---|
|  Unit weight | 4,40 |
|  color |  rot |
|  piece unit | 200 Pal |
|  accessories | 4 x M-1240 M12x40, 50 |



Streifen

Strips for slated body / lame pour clair Voie





WST 430

LINKS / LEFT / GAUCHE
NIO 241 27

024127 III

RECHTS / RIGHT / DROITE
NIO 241 28

024128 III

| | |
|---|--|
|  Unit weight | 3,00 |
|  color |  rot |
|  piece unit | 300 Pal |
|  accessories | |



Streifen

Strips for slated body / lame pour clair Voie





WST 430

LINKS / LEFT / GAUCHE
NIO 241 29

024129 I

RECHTS / RIGHT / DROITE
NIO 241 30

024130 I

| | |
|---|---|
|  Unit weight | 8,20 |
|  color |  rot |
|  piece unit | 100 Pal |
|  accessories | 1 x M-1240 M12x40, 50 |



Streifen

Strips for slated body / lame pour clair Voie





WST 430

LINKS / LEFT / GAUCHE
NIO 241 31

024131 IV

RECHTS / RIGHT / DROITE
NIO 241 32

024132 IV

| | |
|---|--|
|  Unit weight | 3,50 |
|  color |  rot |
|  piece unit | 300 Pal |
|  accessories | 2 x M-1240 M12x40, 50 |



Streifen





Strips for slated body / lame pour clair Voie

LINKS / LEFT / GAUCHE
PR9 002 03P

NIO 241 27

RECHTS / RIGHT / DROITE
PR9 001 03P

NIO 241 28

| | |
|---|---|
|  Unit weight | 3,00 |
|  color |  rot |
|  piece unit | 300 Pal |
|  accessories | 2 x D-1235 11014D123 |



Streifen





Strips for slated body / lame pour clair Voie

LINKS / LEFT / GAUCHE
PRO 002 01P

PR00201P PR021

RECHTS / RIGHT / DROITE
PRO 001 01P

PR00101P PR011

| | |
|---|--|
|  Unit weight | 3,00 |
|  color |  rot |
|  piece unit | 300 Pal |
|  accessories | 3 x D-1235 11014D123 |



Teile passend zu
parts interchangeable
Pièces adaptables pour

Vogel & Noot

Streifen

Strips for slated body / Lame pour clair Voie

LINKS / LEFT / GAUCHE





PRO 002 02P

PR000202P PR022

RECHTS / RIGHT / DROITE

PRO 001 02P

PR000102P PR012

| | |
|---|---|
|  Unit weight | 3,55 |
|  color |  rot |
|  piece unit | 250 Pal |
|  accessories | 3 x D-1235 11014D123 |



Streifen

Strips for slated body / Lame pour clair Voie

LINKS / LEFT / GAUCHE





PRO 002 03P

PR000203P PR023

RECHTS / RIGHT / DROITE

PRO 001 03P

PR000103P PR013

| | |
|---|--|
|  Unit weight | 2,67 |
|  color |  rot |
|  piece unit | 350 Pal |
|  accessories | 3 x D-1235 11014D123 |



Streifen

Strips for slated body / Lame pour clair Voie

LINKS / LEFT / GAUCHE





PRO 002 04P

PR000204P PR024

RECHTS / RIGHT / DROITE

PRO 001 04P

PR000104P PR014

| | |
|---|---|
|  Unit weight | 2,00 |
|  color |  rot |
|  piece unit | 500 Pal |
|  accessories | 3 x D-1235 11014D123 |



Streifen

Strips for slated body / Lame pour clair Voie

LINKS / LEFT / GAUCHE





PR3 002 04P

PR3 00204

RECHTS / RIGHT / DROITE

PR3 001 04P

PR300104

| | |
|---|--|
|  Unit weight | 4,10 |
|  color |  rot |
|  piece unit | 250 Pal |
|  accessories | 3 x D-1235 11014D123 |



Streifen

Strips for slated body / Lame pour clair Voie

LINKS / LEFT / GAUCHE





PR3 002 01P

PR300201

RECHTS / RIGHT / DROITE

PR3 001 01P

PR300101

| | |
|---|---|
|  Unit weight | 4,70 |
|  color |  rot |
|  piece unit | 200 Pal |
|  accessories | 4 x D-1235 11014D123 |



Streifen

Strips for slated body / Lame pour clair Voie

LINKS / LEFT / GAUCHE





PR3 002 02P

PR300202

RECHTS / RIGHT / DROITE

PR3 001 02P

PR300102

| | |
|---|--|
|  Unit weight | 5,00 |
|  color |  rot |
|  piece unit | 200 Pal |
|  accessories | 3 x D-1235 11014D123 |



Streifen

Strips for slated body / Lame pour clair Voie

LINKS / LEFT / GAUCHE





PR3 002 03P

PR300203

RECHTS / RIGHT / DROITE

PR3 001 03P

PR300103P

| | |
|---|---|
|  Unit weight | 3,80 |
|  color |  rot |
|  piece unit | 250 Pal |
|  accessories | 2 x D-1235 11014D123 |



Streifen

Strips for slated body / Lame pour clair Voie

LINKS / LEFT / GAUCHE





PR9 002 01P

PR900201 WST430 I

RECHTS / RIGHT / DROITE

PR9 001 01P

PR900101 WST430 I

| | |
|---|--|
|  Unit weight | 8,30 |
|  color |  rot |
|  piece unit | 100 Pal |
|  accessories | 3 x D-1235 11014D123 |



Teile passend zu
parts interchangeable
Pièces adaptables pour

Vogel & Noot

Streifen

Strips for slated body / Lame pour clair Voie





LINKS / LEFT / GAUCHE RECHTS / RIGHT / DROITE

PR9 002 02P

PR9 001 02P

PR900202 WST430 II LI

PR900102 WST430 II

| | |
|---|---|
|  Unit weight | 4,30 |
|  color |  rot |
|  piece unit | 200 Pal |
|  accessories | 3 x D-1235 11014D123 |



Streifen

Strips for slated body / Lame pour clair Voie





LINKS / LEFT / GAUCHE RECHTS / RIGHT / DROITE

PR9 002 03P

PR9 001 03P

PR900203 WST III LI

NIO 241 28

| | |
|---|--|
|  Unit weight | 3,00 |
|  color |  rot |
|  piece unit | 300 Pal |
|  accessories | 2 x D-1235 11014D123 |



Streifen

Strips for slated body / Lame pour clair Voie





LINKS / LEFT / GAUCHE RECHTS / RIGHT / DROITE

PR9 002 04P

PR9 001 04P

PR900204 WST430 IV

PR900104 WST430 IV

| | |
|---|---|
|  Unit weight | 3,55 |
|  color |  rot |
|  piece unit | 250 Pal |
|  accessories | 4 x D-1235 11014D123 |



Verschleißstück - Streichblech - Vorderenteil

WST 430

Wearing part - Moulboard - Front part / Etrave





LINKS / LEFT / GAUCHE RECHTS / RIGHT / DROITE

NIO 240 81

NIO 240 80

024081

024080

| | |
|---|--|
|  Unit weight | 2,75 |
|  color |  rot |
|  piece unit | 400 Pal |
|  accessories | 3 x M-1240 M12x40, 5C |



Verschleißstück - Streichblech - Vorderenteil

MPK400

Wearing part - Moulboard - Front part / Etrave





LINKS / LEFT / GAUCHE RECHTS / RIGHT / DROITE

PR4 002 02K

PR4 001 02K

MPK 400

MPK400

| | |
|---|---|
|  Unit weight | 2,60 |
|  color |  rot |
|  piece unit | Pal |
|  accessories | 3 x D-1235 11014D123 |



Verschleißstück - Streichblech - Vorderenteil

Wearing part - Moulboard - Front part / Etrave





LINKS / LEFT / GAUCHE RECHTS / RIGHT / DROITE

PK1 002 02K

PK1 001 02K

NL 460

NL460

| | |
|---|------|
|  Unit weight | 1,77 |
|  color | |
|  piece unit | |
|  accessories | |





Verschleißstück - Streichblech - Vorderenteil

Wearing part - Moulboard - Front part / Etrave

RECHTS / RIGHT / DROITE

PK1 001 02

NL460 PK112 BP-365P

| | |
|---|---|
|  Unit weight | 1,77 |
|  color |  rot |
|  piece unit | |
|  accessories | 3 x D-1235 11014D123 |



Verschleißstück - Streichblech - Vorderenteil





W 275

Wearing part - Moulboard - Front part / Etrave

RECHTS / RIGHT / DROITE

P50 001 02

P5000102 W275 re

| | |
|---|--|
|  Unit weight | 1,40 |
|  color |  rot |
|  piece unit | 700 Pal |
|  accessories | 2 x B-1035 608D1035N |



Teile passend zu
parts interchangeable
Pièces adaptables pour

Vogel & Noot

Verschleißstück - Streichblech - Vorderteil

Wearing part - Moulboard - Front part / Etrave

WS275

LINKS / LEFT / GAUCHE





P51 016 03

P5101603 WS275 li

RECHTS / RIGHT / DROITE

P51 015 03

P5101503 WS275 re

| | |
|---|---|
|  Unit weight | 1,10 |
|  color |  rot |
|  piece unit | Pal |
|  accessories | 2 x B-1035 608D1035N |



Verschleißstück - Streichblech - Vorderteil

Wearing part - Moulboard - Front part / Etrave

LINKS / LEFT / GAUCHE





P52 002 03P

P5200203 W300 L

RECHTS / RIGHT / DROITE

P52 001 03P

P5200103 W300

| | |
|---|--|
|  Unit weight | 2,30 |
|  color |  rot |
|  piece unit | 400 Pal |
|  accessories | 2 x B-1035 608D1035N |



Verschleißstück - Streichblech - Vorderteil





Wearing part - Moulboard - Front part / Etrave

WSU350

RECHTS / RIGHT / DROITE

P59 001 03

P5900103 WSU350 re

| | |
|---|---|
|  Unit weight | 2,00 |
|  color |  rot |
|  piece unit | Pal |
|  accessories | 3 x B-1035 608D1035N |



Verschleißstück - Streichblech - Vorderteil

Wearing part - Moulboard - Front part / Etrave

LINKS / LEFT / GAUCHE





PK0 002 02P

PK000202P WS400/WL430

RECHTS / RIGHT / DROITE

PK0 001 02P

PK000102P WS400/WL430

| | |
|---|--|
|  Unit weight | 2,20 |
|  color |  rot |
|  piece unit | 400 Pal |
|  accessories | 2 x D-1235 11014D123 |



Verschleißstück - Streichblech - Vorderteil

Wearing part - Moulboard - Front part / Etrave

LINKS / LEFT / GAUCHE





PK2 002 03BP

PK200203 UN300L

RECHTS / RIGHT / DROITE

PK2 001 03BP

PK200103 UN300

| | |
|---|---|
|  Unit weight | 1,45 |
|  color |  rot |
|  piece unit | 500 Pal |
|  accessories | 2 x D-1235 11014D123 |



Verschleißstück - Streichblech - Vorderteil

Wearing part - Moulboard - Front part / Etrave

LINKS / LEFT / GAUCHE





PK3 002 03BP

PK300203BP UN350L

RECHTS / RIGHT / DROITE

PK3 001 03BP

VST1120 CV000045

| | |
|---|--|
|  Unit weight | 1,60 |
|  color |  rot |
|  piece unit | 500 Pal |
|  accessories | 2 x D-1235 11014D123 |



Verschleißstück - Streichblech - Vorderteil

Wearing part - Moulboard - Front part / Etrave

LINKS / LEFT / GAUCHE





PK4 002 03BP

PK400203BP UN400L

RECHTS / RIGHT / DROITE

PK4 001 03BP

VST1160 CV000047

| | |
|---|---|
|  Unit weight | 1,67 |
|  color |  rot |
|  piece unit | 500 Pal |
|  accessories | 2 x D-1235 11014D123 |



Verschleißstück - Streichblech - Vorderteil

Wearing part - Moulboard - Front part / Etrave

LINKS / LEFT / GAUCHE





PK5 002 03BP

PK500203BP UN430L

RECHTS / RIGHT / DROITE

PK5 001 03BP

PK500103BP UN430

| | |
|---|--|
|  Unit weight | 1,95 |
|  color |  rot |
|  piece unit | 500 Pal |
|  accessories | 2 x D-1235 11014D123 |



Teile passend zu
parts interchangeable
Pièces adaptables pour

Vogel & Noot

Verschleißstück - Streichblech - Vorderteil





Wearing part - Moulboard - Front part / Etrave

LINKS / LEFT / GAUCHE
PK6 006 00BP

PK600600BP WS/WY350L

RECHTS / RIGHT / DROITE
PK6 005 00BP

190 3562

| | |
|---|---|
|  Unit weight | 0,96 |
|  color |  rot |
|  piece unit | 400 Pal |
|  accessories | 1 x D-1030, 523742V |



Verschleißstück - Streichblech - Vorderteil





Wearing part - Moulboard - Front part / Etrave

LINKS / LEFT / GAUCHE
PK8 006 01BAP

PK8 00601 BAP WY400 alt

RECHTS / RIGHT / DROITE
PK8 005 01BAP

PK8 00501 BAP WY400 alt

| | |
|---|--|
|  Unit weight | 2,15 |
|  color |  rot |
|  piece unit | 500 Pal |
|  accessories | 3 x D-1030, 523742V |



Verschleißstück - Streichblech - Vorderteil





Wearing part - Moulboard - Front part / Etrave

LINKS / LEFT / GAUCHE
PK8 006 01P

PK800601P WY400L

RECHTS / RIGHT / DROITE
PK8 005 01P

PK800501P W400

| | |
|---|---|
|  Unit weight | 2,15 |
|  color |  rot |
|  piece unit | 400 Pal |
|  accessories | 3 x D-1030, 523742V |



Verschleißstück - Streichblech - Vorderteil

Wearing part - Moulboard - Front part / Etrave





M350

LINKS / LEFT / GAUCHE
PK9 002 02B

PK900202 M350 li

RECHTS / RIGHT / DROITE
PK9 001 02B

PK900102 M350 re

| | |
|---|--|
|  Unit weight | 2,16 |
|  color |  rot |
|  piece unit | 450 Pal |
|  accessories | 2 x D-1235 11014D123 |



Verschleißstück - Streichblech - Vorderteil

Wearing part - Moulboard - Front part / Etrave





MPK400

LINKS / LEFT / GAUCHE
PR5 002 02B

PR500202 MPK 430 li

RECHTS / RIGHT / DROITE
PR5 001 02B

PR500102 MPK 430 re

| | |
|---|---|
|  Unit weight | 5,20 |
|  color |  rot |
|  piece unit | 200 Pal |
|  accessories | 4 x D-1235 11014D123 |



Verschleißstück - Streichblech - Vorderteil





Wearing part - Moulboard - Front part / Etrave

LINKS / LEFT / GAUCHE
PR9 002 05P

PR900205P

RECHTS / RIGHT / DROITE
PR9 001 05P

PR900105 WST430

| | |
|---|--|
|  Unit weight | 2,85 |
|  color |  rot |
|  piece unit | 300 Pal |
|  accessories | 3 x D-1235 11014D123 |



Verschleißstück - Streichblech - Vorderteil





Wearing part - Moulboard - Front part / Etrave

LINKS / LEFT / GAUCHE
PR7 000 04P

WX400 WXL430

RECHTS / RIGHT / DROITE
PR7 000 03P

WX400 WXL430

| | |
|---|---|
|  Unit weight | 1,41 |
|  color |  rot |
|  piece unit | 500 Pal |
|  accessories | 2 x D-1235 11014D123 |



Verschleißstück - Streichblech - Vorderteil





Wearing part - Moulboard - Front part / Etrave

LINKS / LEFT / GAUCHE
Z23 357 03P

Z2335703

RECHTS / RIGHT / DROITE
Z23 356 03P

Z2335603

| | |
|---|--|
|  Unit weight | 0,80 |
|  color |  rot |
|  piece unit | |
|  accessories | |



Teile passend zu
parts interchangeable
Pièces adaptables pour

Widder

Anlage

Landside / Contre-Sep

LINKS / LEFT / GAUCHE





CV0 000 68

K 1093

RECHTS / RIGHT / DROITE

CV0 000 67

K 1083

| | |
|---|---|
|  Unit weight | 3,60 |
|  color |  rot |
|  piece unit | 250 Pal |
|  accessories | 2 x D-1235 11014D123 1 x A-1640, 548350V |



Schare

Share / Soc

LINKS / LEFT / GAUCHE





CV0 000 16

SS 1150, SS1110

RECHTS / RIGHT / DROITE

CV0 000 15

SS 1140

| | |
|---|--|
|  Unit weight | 4,90 |
|  color |  rot |
|  piece unit | 150 Pal |
|  accessories | 3 x D-1235 11014D123 |



Verschleißstück - Streichblech - Vorderteil

Wearing part - Moulboard - Front part / Etrave

LINKS / LEFT / GAUCHE





CE1 000 85

40 003

RECHTS / RIGHT / DROITE

CE1 000 84

40 002

| | |
|---|---|
|  Unit weight | 2,00 |
|  color |  rot |
|  piece unit | 500 Pal |
|  accessories | 2 x D-1235 11014D123 |



SÄMASCHINE

SEED DRILL MACHINE

SEMOIR

СЕЯЛКИ

SEMBRADORA

SEMINATRICE

VETŐGÉP

SIEWNIK

SEJALICA

SEJALNICA

SEMANATORI









Teile passend zu
parts interchangeable
Pièces adaptables pour

AMAZONE

Scheibe
Disc / Disque

CA3 000 08

961301 400X4 DRILLDISC

| | |
|---|---|
|  Unit weight | 4,04 |
|  color |  schwarz |
|  piece | 200 |
|  unit | Pal |
|  accessories | |









Teile passend zu
parts interchangeable
Pièces adaptables pour

Horsch

Scheibe
Disc / Disque

CHO 000 40

2301 0201 340x2,5 GL

| | |
|---|---|
|  Unit weight | 1,70 |
|  color |  schwarz |
|  piece | 400 |
|  unit | Pal |
|  accessories | |









Teile passend zu
parts interchangeable
Pièces adaptables pour

Lemken

Scheibe
Disc / Disque

CL1 002 17

349 0010







| | |
|---|--|
|  Unit weight | 2,00 |
|  color |  blau |
|  piece | 100 |
|  unit | Pal |
|  accessories | |



Scheibe
Disc / Disque

CL1 001 87

582 6028 Solitär

| | |
|---|--|
|  Unit weight | 2,11 |
|  color |  schwarz |
|  piece | 100 |
|  unit | Pal |
|  accessories | |

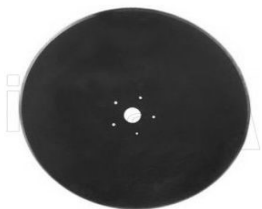

Teile passend zu
parts interchangeable
Pièces adaptables pour

Vogel & Noot

Scheibe

Disc / Disque

NZ1 340 16

NIROSTA M.SCHNEIDE 3MM/2MM

 Unit weight 1,57

 color

 piece
unit

 accessories



SCHEIBENEGGE

DISK HARROW
HERSES À DISQUES
ДИСКОВЫЕ БОРОНЫ
GRADA DE DISCOS
DISCO
RÖVID TÁRCSA
BRONA TALERZOWA
GRAPĂ CU DISCURI
DISKOVI
GRAPĂ CU DISCURI



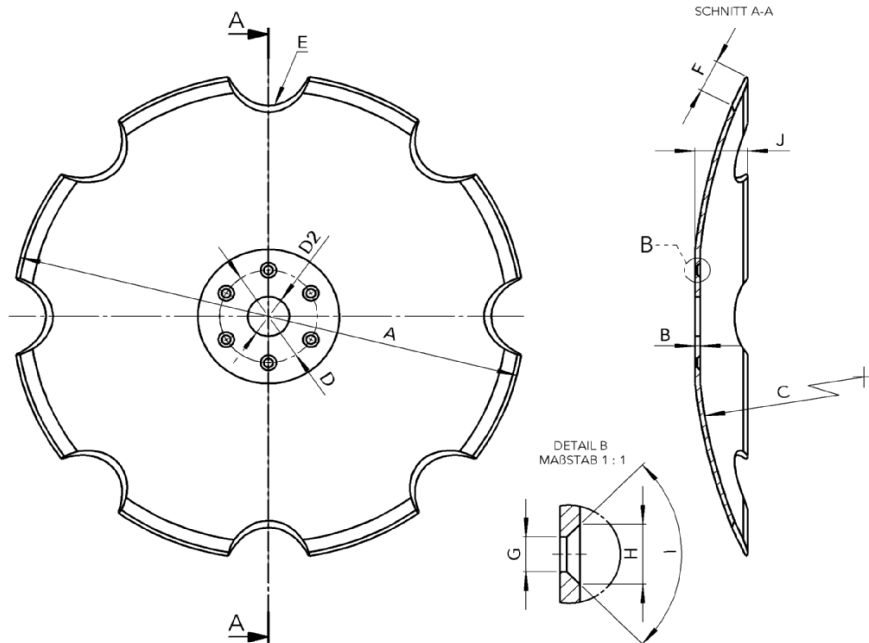

Disk's
Disques
Диск
Disco
Črtala, diski
Tárcsa
Talerz kroju
Disk
Črtala diski
Disc

dimensions in mm

| Artikel Nr. | Marke/brand | Original number | dimensions in mm | | | | | | | | | | | comment | |
|-------------|-----------------|-----------------|------------------|-----|-----|--------------|-----|----|----|-----|---|----|----|---------|-----------|
| | | | A | B | C | Ø/□ | Ø/□ | ±□ | ±□ | Ø/□ | H | I | J | | |
| CA3 000 01 | Amazone | XL 011 | 460 | 4 | 335 | 110 | | | | | | | | 42 | unnotched |
| CA3 000 03 | Amazone | XL 034 | 460 | 4 | 335 | 110 | | | 83 | 38 | | | | 42 | notched |
| CA3 000 05 | Amazone | XL 041 | 460 | 4 | 335 | 120 | | | | | | | | 42 | unnotched |
| CA3 000 06 | Amazone | XL 043 | 460 | 4 | 289 | 120 | | | 90 | 41 | | | | 45 | notched |
| CA3 000 07 | Amazone | 78201966 | 510 | 5 | 331 | 120 | | | 99 | 46 | | | | 50 | notched |
| CA3 000 07V | Amazone | 78201966V | 510 | 6 | 331 | 120 | | | 99 | 46 | | | | 50 | notched |
| CA3 000 08 | Amazone | 961301 | 400 | 4 | | 104 | | | | | | 18 | 90 | 21 | plain |
| CF1 000 08 | Farmet | 300 76 53 | 510 | 6 | 566 | 98 | | | 80 | 35 | | | | 63 | notched |
| CG3 000 01 | Great Plains | 013-514 B | 343 | 3,5 | | 80/ 105,5 | Ø44 | | | | | | | | plain |
| CG3 000 02 | Great Plains | 015-014B | 381 | 4 | | 80/ 105,5 | Ø44 | | | | | | | | plain |
| CG3 000 03 | Great Plains | 411-310A4 | 460 | 5 | | 111,7 | Ø76 | | | | | | | | plain |
| CG3 000 04 | Great Plains | 411-310A1 | 460 | 4 | | 111,7 | Ø76 | | | | | | | | plain |
| CG1 000 09 | Gregoire Besson | 851 000 998 | 660 | 6 | 575 | | □41 | 83 | 52 | | | | | 104 | notched |
| CG1 000 10 | Gregoire Besson | 851 001 098 | 660 | 6 | 575 | | □41 | | | | | | | 104 | unnotched |
| CG1 001 13 | Gregoire Besson | CG1 001 13 | 660 | 6,5 | 575 | | □41 | 83 | 52 | | | | | 104 | notched |
| CG1 001 14 | Gregoire Besson | CG1 001 14 | 660 | 6,5 | 575 | | □41 | | | | | | | 104 | unnotched |

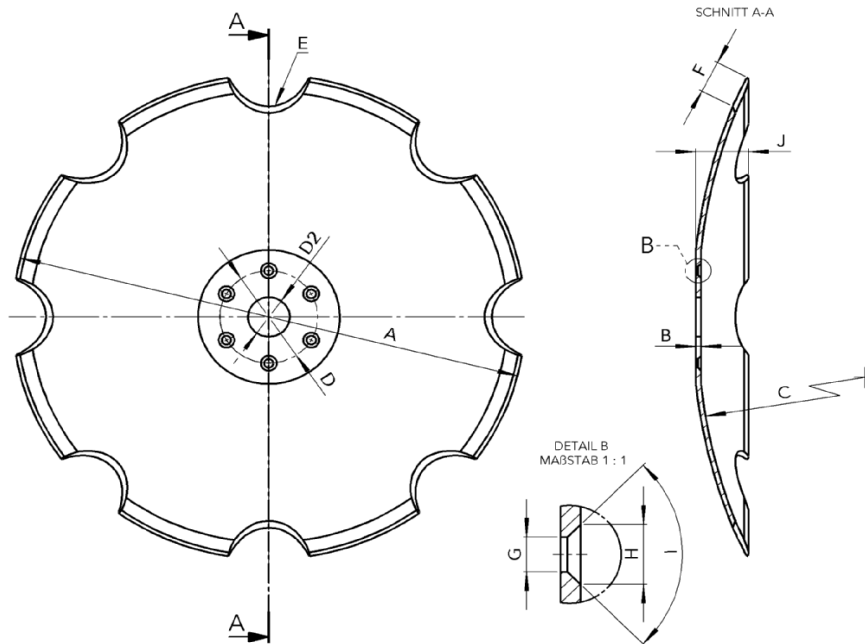

Disk's
Disques
Диск
Disco
Črtala, diski
Tárcsa
Talerz kroju
Disk
Črtala diski
Disc

dimensions in mm

| Artikel Nr. | Marke/brand | Original number | dimensions in mm | | | | | | | | | | | comment |
|-------------|--------------|-----------------|------------------|-----|-----|-------|--------|----|----|-----------------------|---|------|----|-----------|
| | | | A | B | C | Ø/□ D | Ø/□ D2 | ±E | ±F | Ø/□ G | H | I | J | |
| CH0 00034 | Horsch | 0031 1081 | 684 | 7 | 700 | 150 | | 80 | 60 | 6 x Ø16 | | | 57 | notched |
| CH0 00035 | Horsch | 0031 0988 | 684 | 6 | 575 | 150 | | 80 | 55 | 6 x Ø16 | | | 57 | notched |
| CH0 00036 | Horsch | 2324 6106 | 460 | 6 | 600 | 100 | | 76 | 48 | 3 x Ø12,5 | | | 57 | notched |
| CH0 00037 | Horsch | 2807 1304 | 460 | 6 | 600 | 100 | | 76 | 48 | 5 x Ø12,5 | | | 57 | notched |
| CH0 00038 | Horsch | 2807 1305 | 520 | 6 | 813 | 105 | | 80 | 35 | 5 x Ø12,5 | | | 58 | notched |
| CH0 00039 | Horsch | 2324 6102 | 460 | 4 | 813 | 98 | | 87 | 35 | 3 x Ø12,5 | | | 43 | notched |
| CH0 00040 | Horsch | 2301 0201 | 340 | 2,5 | | 60 | Ø37 | | | 4 x Ø8 / 2 x Ø8,5* | | *60° | 29 | plain |
| CH0 00059 | Horsch | 0310914 | 355 | 4 | | 73 | Ø40 | | | 6 x Ø6,8 | | | | plain |
| CH0 00060 | Horsch | 0311103 | 620 | 6 | 430 | 125 | | 82 | 41 | 6 x Ø12,5 | | | | notched |
| CK4 10028 | Köckerling | 910964 | 510 | 5 | 595 | 98 | | 80 | 41 | 4 x Ø12,5 | | | 55 | notched |
| CL0 001 18 | Pöttinger L. | 850 41 023 0 | 510 | 4,5 | 600 | 110 | | 80 | | 4 x Ø13 | | | 56 | notched |
| CL0 001 19 | Pöttinger L. | 850 41 024 0 | 510 | 4,5 | 600 | 110 | | | | 4 x Ø13 | | | 56 | unnotched |
| CL0 001 45 | Pöttinger L. | 771 03 025 1 | 585 | 5 | 645 | 110 | | 82 | 35 | 4 x Ø12,5 | | | 64 | notched |
| CL1 001 76 | Lemken | 349 0466 | 620 | 6 | 700 | 130 | | 98 | 40 | 6 x □12,5 | | | 57 | notched |
| CL1 001 87 | Lemken | 582 6028 | 350 | 3 | | 70 | Ø36 | | | 6 x Ø6,5 | | | | plain |
| CL1 001 91 | Lemken | 349 0467 | 620 | 6 | 900 | 160 | | 99 | 45 | 5 x □13 | | | 57 | notched |
| CL1 002 17 | Lemken | 349 0010 | 350 | 3 | | 70 | Ø35,5 | | | 6 x Ø7 | | | | plain |
| CL1 002 29 | Lemken | 349 10017 | 736 | 6 | 936 | 195 | | 95 | 47 | 6 x □12,5 | | | 68 | notched |
| CL1 002 30 | Lemken | 349 0471 | 465 | 5 | 730 | 100 | | 65 | 26 | 6 x Ø10,5 | | | 40 | notched |
| CL1 002 31 | Lemken | 349 10027 | 510 | 5 | 730 | 105 | | 95 | 36 | 4 x Ø12,5 | | | 41 | notched |

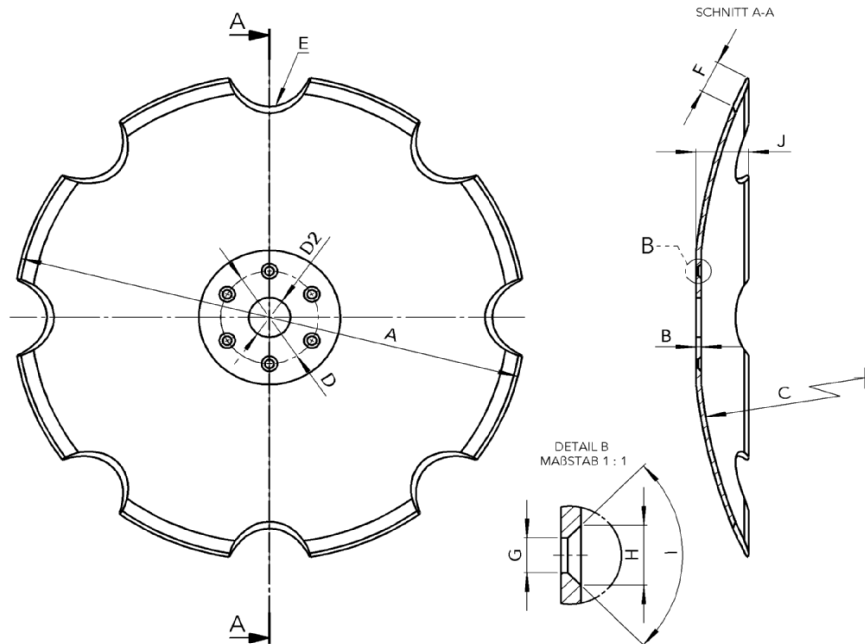

Disk's
Disques
Диск
Disco
Črtala, diski
Tárcsa
Talerz kroju
Disk
Črtala diski
Disc

dimensions in mm

| Artikel Nr. | Marke/brand | Original number | dimensions in mm | | | | | | | | | | | comment |
|-------------|--------------|--------------------------|------------------|-----|------|-------|-----|------|----|-----------|------|-----|-----|-----------|
| | | | A | B | C | D | D2 | E | F | G | H | I | J | |
| CM4 000 01 | Mandam | 05-02-0127 | 560 | 4 | 696 | 115 | Ø26 | 78 | 40 | 4 x Ø13 | | | 71 | notched |
| CM4 000 02 | Mandam | 05-02-0133 | 465 | 4 | 587 | 100 | Ø26 | 80 | 40 | 4 x Ø11 | | | 52 | notched |
| CP4 000 01 | POUCHAIN | PAP025016 | 700 | 6 | | 141,4 | Ø80 | | | 4 x Ø13 | | | | unnotched |
| CQ0 000 06 | Quivogne | DSQ 06616 | 660 | 6,5 | 575 | | □51 | | | | | | 104 | unnotched |
| CQ0 000 07 | Quivogne | DSQ 06615 | 660 | 6,5 | 575 | | □51 | 83 | 52 | | | | 104 | notched |
| CR0 002 46 | Rabe | 90311329 | 460 | 6 | 1045 | 98 | | 21,5 | 14 | 4 x Ø12,5 | | | 26 | notched |
| CV0 060 64 | Sunflower | CV0 060 64 | 560 | 6 | | | Ø45 | | | | | | 72 | unnotched |
| CV3 000 09 | Vaerdestad | 451372/423574/ 444568 | 410 | 5 | | 103,5 | | 21,5 | 12 | 5 x Ø12,5 | | | | notched |
| CV3 000 10 | Vaerdestad | 451371 | 410 | 5 | | 103,5 | | 21,5 | 12 | 5 x Ø12,5 | | | | notched |
| CV3 000 11 | Vaerdestad | 451793/305501 | 370 | 5 | | 103,5 | | 20 | 12 | 5 x Ø12,5 | | | | notched |
| CV3 000 12 | Vaerdestad | 466947 | 445 | 5 | | 98 | | 20 | 10 | 4 x Ø13 | 15,5 | 60° | 38 | notched |
| CV3 000 18 | Vaerdestad | 459114/459608/ 444687 | 430 | 5 | | 98 | | 21,5 | 13 | 4 x Ø12,5 | 16 | 60° | 36 | notched |
| RA1 324 06 | Vogel & Noot | RA1 324 06 | 510 | 5 | 1045 | 98 | | 22 | 21 | 4 x Ø12,5 | | | 30 | notched |
| R23 204 02 | Vogel & Noot | R23 204 02 | 610 | 6 | 700 | 98 | | 93 | 53 | 6 x Ø12,5 | | | 65 | notched |
| R23 204 01 | Vogel & Noot | R23 204 01 | 510 | 5 | 500 | 98 | | 88 | 42 | 6 x Ø12,5 | | | 43 | notched |
| R23 204 03 | Vogel & Noot | R23 204 03 | 560 | 5 | 595 | 98 | | 75 | 32 | 6 x Ø12,5 | | | 65 | notched |
| NZ 134016 | Vogel & Noot | NZ 134016 | 315 | 3 | | 96 | Ø60 | | | 6 x Ø6,1 | | | | plain |
| CV0 08026 | Universal | R2428CE | 566 | 6 | 628 | 120 | Ø45 | 87 | 35 | 6 x Ø13,5 | 14,5 | | 67 | notched |
| CK0 00152 | Kverneland | A135419697 | 600 | 6 | | 112 | | 40 | 18 | 5 x Ø12,5 | | | 60 | notched |





Teile passend zu
parts interchangeable
Pièces adaptables pour

AMAZONE

Scheibe
Disc / Disque

CA3 000 07

78201966 510X5 LK120 CATROS





| | |
|---|-----------|
|  Unit weight | 7,00 |
|  color | ■ schwarz |
|  piece unit | 100 Pal |
|  accessories | |



Scheibe
Disc / Disque

CA3 000 07V

78201966V 510X6 CATROS GEZ



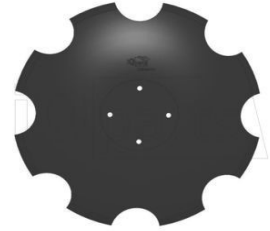

| | |
|---|-----------|
|  Unit weight | 8,40 |
|  color | ■ schwarz |
|  piece unit | 100 Pal |
|  accessories | |



Scheibe
Disc / Disque

CA3 000 03

XL 034 460 x 4





| | |
|---|-----------|
|  Unit weight | 0,00 |
|  color | ■ schwarz |
|  piece unit | 100 Pal |
|  accessories | |



Scheibe
Disc / Disque

CA3 000 01

XL011 460 x 4 glatt





| | |
|---|-----------|
|  Unit weight | 0,00 |
|  color | ■ schwarz |
|  piece unit | 100 Pal |
|  accessories | |



Scheibe
Disc / Disque

CA3 000 05

XL041 460x4





| | |
|---|-----------|
|  Unit weight | 5,10 |
|  color | ■ schwarz |
|  piece unit | |
|  accessories | |



Scheibe
Disc / Disque

CA3 000 06

XL043 460X4 LK120 GEZ

| | |
|---|-----------|
|  Unit weight | 4,55 |
|  color | ■ schwarz |
|  piece unit | 200 Pal |
|  accessories | |



Teile passend zu
parts interchangeable
Pièces adaptables pour

Great Plains

Scheibe

Disc / Disque

CG3 000 01

013-514B 343x3,5mm

| | | |
|--|-------------|-----------|
| | Unit weight | 2,38 |
| | color | ■ schwarz |
| | piece unit | 300 pal |
| | accessories | |



Scheibe

Disc / Disque

CG3 000 02

015-014B 381x4mm

| | | |
|--|-------------|-----------|
| | Unit weight | 3,38 |
| | color | ■ schwarz |
| | piece unit | 300 Pal |
| | accessories | |



Scheibe

Disc / Disque

CG3 000 04

411-310A1 460X4mm

| | | |
|--|-------------|-----------|
| | Unit weight | 4,71 |
| | color | ■ schwarz |
| | piece unit | 300 Pal |
| | accessories | |



Scheibe

Disc / Disque

CG3 000 03

411-310A4 460X5mm

| | | |
|--|-------------|-----------|
| | Unit weight | 5,74 |
| | color | ■ schwarz |
| | piece unit | 300 Pal |
| | accessories | |



Teile passend zu
parts interchangeable
Pièces adaptables pour





Gregoire Besson

Scheibe

Disc / Disque

CG1 000 09

851 000 998

| | | |
|---|-------------|-----------|
|  | Unit weight | 15,10 |
|  | color | ■ schwarz |
|  | piece unit | 50 Pal |
|  | accessories | |







Scheibe

Disc / Disque

CG1 000 10

851 001 098

| | | |
|---|-------------|-----------|
|  | Unit weight | 16,50 |
|  | color | ■ schwarz |
|  | piece unit | 50 Pal |
|  | accessories | |







Scheibe

Disc / Disque

CG1 001 13

851 001 198 660x6,5 notched

| | | |
|---|-------------|-----------|
|  | Unit weight | 15,10 |
|  | color | ■ schwarz |
|  | piece unit | 50 Pal |
|  | accessories | |

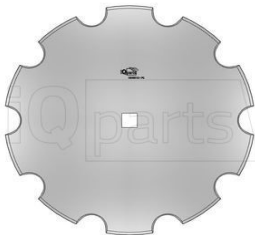





Scheibe

Disc / Disque

CG1 001 14

851 001 298 660x6,5 plain

| | | |
|---|-------------|-----------|
|  | Unit weight | 15,10 |
|  | color | ■ schwarz |
|  | piece unit | 50 Pal |
|  | accessories | |

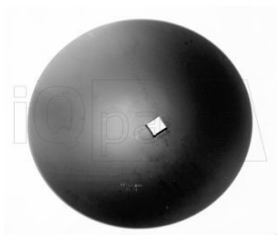

Teile passend zu
parts interchangeable
Pièces adaptables pour





Horsch

Scheibe

Disc / Disque

CHO 000 35

0031 0988 684x6 gez

| | |
|---|---|
|  Unit weight | 12,50 |
|  color |  schwarz |
|  piece unit | 50 Pal |
|  accessories | |







Scheibe

Disc / Disque

CHO 000 34

0031 1081 684x7 gez

| | |
|---|--|
|  Unit weight | 15,28 |
|  color |  schwarz |
|  piece unit | 50 Pal |
|  accessories | |







Scheibe

Disc / Disque

CHO 000 59

0310914 D355X4

| | |
|---|---|
|  Unit weight | 2,89 |
|  color |  schwarz |
|  piece unit | 300 Pal |
|  accessories | |







Scheibe

Disc / Disque

CHO 000 60

0311103 D620X6 6-holes

| | |
|---|--|
|  Unit weight | 13,30 |
|  color |  schwarz |
|  piece unit | 50 Pal |
|  accessories | |







Scheibe

Disc / Disque

CHO 000 39

2324 6102 460x4 gez

| | |
|---|---|
|  Unit weight | 4,60 |
|  color |  schwarz |
|  piece unit | 100 Pal |
|  accessories | |

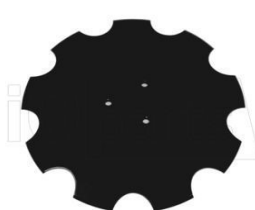





Scheibe

Disc / Disque

CHO 000 36

2324 6106 460x6 gez

| | |
|---|--|
|  Unit weight | 7,00 |
|  color |  schwarz |
|  piece unit | 100 Pal |
|  accessories | |







Scheibe

Disc / Disque

CHO 000 37

2807 1304 460x6gez

| | |
|---|---|
|  Unit weight | 0,00 |
|  color |  schwarz |
|  piece unit | 100 Pal |
|  accessories | |







Scheibe

Disc / Disque

CHO 000 38

2807 1305 520x6 gez

| | |
|---|--|
|  Unit weight | 0,00 |
|  color |  schwarz |
|  piece unit | 100 Pal |
|  accessories | |







Teile passend zu
parts interchangeable
Pièces adaptables pour

KÖCKERLING

Scheibe
Disc / Disque

CK4 100 28

910964 510X5 gez.

| | |
|---|---|
|  Unit weight | 0,00 |
|  color |  schwarz |
|  piece unit | Pal |
|  accessories | |





Teile passend zu
parts interchangeable
Pièces adaptables pour

Kverneland

Scheibe
Disc / Disque

CK0 001 52

A135419697 CONICAL 600X6

| | |
|---|---|
|  Unit weight | 12,67 |
|  color |  schwarz |
|  piece unit | 100 Pal |
|  accessories | |



Teile passend zu
parts interchangeable
Pièces adaptables pour

Lemken

Scheibe
Disc / Disque

CL1 001 76

349 0466 RUBIN

| | | |
|--|-------------|--|
| | Unit weight | 12,50 |
| | color | ■ blau |
| | piece unit | 50 Pal |
| | accessories | 6 x P-1230 M12x30 Mu, |

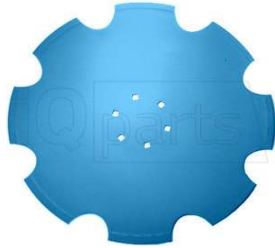

Scheibe
Disc / Disque

CL1 001 91

349 0467

| | | |
|--|-------------|--|
| | Unit weight | 12,50 |
| | color | ■ blau |
| | piece unit | 50 Pal |
| | accessories | 5 x P-1230 M12x30 Mu, |



Scheibe
Disc / Disque

CL1 002 30

3490471 D465x5x40 LK100

| | | |
|--|-------------|--|
| | Unit weight | 6,22 |
| | color | ■ blau |
| | piece unit | 100 Pal |
| | accessories | |



Scheibe
Disc / Disque

CL1 002 29

349100017 D736X6X60 RUBIN 12

| | | |
|--|-------------|--|
| | Unit weight | 18,06 |
| | color | ■ blau |
| | piece unit | 50 Pal |
| | accessories | 6 x P-1230 M12x30 Mu, |



Teile passend zu
parts interchangeable
Pièces adaptables pour

Mandam

Scheibe
Disc / Disque

CM4 000 01

05-02-0127 560X4

| | | |
|--|-------------|--|
| | Unit weight | 7,20 |
| | color | ■ schwarz |
| | piece unit | 100 Pal |
| | accessories | |



Scheibe
Disc / Disque

CM4 000 02

05-02-0133 465X4

| | | |
|--|-------------|--|
| | Unit weight | 4,85 |
| | color | ■ schwarz |
| | piece unit | 100 Pal |
| | accessories | |



Teile passend zu
parts interchangeable
Pièces adaptables pour

Pöttinger Landsberg

Scheibe

Disc / Disque

CLO 001 18

850 41 023 0 DM510 gez

| | | |
|--|-------------|-----------|
| | Unit weight | 7,00 |
| | color | ■ schwarz |
| | piece unit | 100 Pal |
| | accessories | |



Scheibe

Disc / Disque

CLO 001 19

850 41 024 0 DM510 glatt

| | | |
|--|-------------|-----------|
| | Unit weight | 6,50 |
| | color | ■ schwarz |
| | piece unit | 100 Pal |
| | accessories | |



Scheibe

Disc / Disque

CLO 001 45

9771.03.025.1 D580X5

| | | |
|--|-------------|-----------|
| | Unit weight | 9,92 |
| | color | ■ schwarz |
| | piece unit | 100 Pal |
| | accessories | |



Teile passend zu
parts interchangeable
Pièces adaptables pour

POUCHAIN

Scheibe

Disc / Disque

CP4 000 01

PAP025016 700X6

| | | |
|--|-------------|-----------|
| | Unit weight | 17,54 |
| | color | ■ schwarz |
| | piece unit | 50 Pal |
| | accessories | |



Teile passend zu
parts interchangeable
Pièces adaptables pour

QUIVOGNE

Scheibe
Disc / Disque

CG1 000 09

DSQ06606 660x6 C41

| | | |
|--|-------------|-----------|
| | Unit weight | 15,10 |
| | color | ■ schwarz |
| | piece unit | 50 Pal |
| | accessories | |



Scheibe
Disc / Disque

CG1 000 10

DSQ06609 660x6 C41

| | | |
|--|-------------|-----------|
| | Unit weight | 16,50 |
| | color | ■ schwarz |
| | piece unit | 50 Pal |
| | accessories | |



Scheibe
Disc / Disque

CQ0 000 06

DSQ06616 D660X6,5 plain

| | | |
|--|-------------|-----------|
| | Unit weight | 18,15 |
| | color | ■ schwarz |
| | piece unit | 50 Pal |
| | accessories | |



Teile passend zu
parts interchangeable
Pièces adaptables pour

RABE

Abstreifer
Scraper /

CRO 002 39

8405 0027 170x80x4mm

| | | |
|--|-------------|-----------|
| | Unit weight | 0,25 |
| | color | ■ schwarz |
| | piece unit | Pal |
| | accessories | |



Scheibe
Disc / Disque

CRO 002 46

90311329 D460x5 gez.

| | | |
|--|-------------|-----------|
| | Unit weight | 0,00 |
| | color | ■ schwarz |
| | piece unit | Pal |
| | accessories | |

Teile passend zu
parts interchangeable
Pièces adaptables pour

SCHEIBEN

Scheibe

Disc / Disque

CV0 060 64

560 x 6

| | | |
|--|-------------|-----------|
| | Unit weight | 17,50 |
| | color | ■ schwarz |
| | piece unit | 100 Pal |
| | accessories | |



Scheibe

Disc / Disque

CF3 000 01

LK100 381x5mm

| | | |
|--|-------------|-----------|
| | Unit weight | 4,25 |
| | color | ■ schwarz |
| | piece unit | 200 Pal |
| | accessories | |

Scheibe

Disc / Disque

CV0 080 26

R2428CE 560X6

| | | |
|--|-------------|-----------|
| | Unit weight | 0,00 |
| | color | ■ schwarz |
| | piece unit | 100 Pal |
| | accessories | |



Teile passend zu
parts interchangeable
Pièces adaptables pour





VAEDERSTAD

Scheibe

Disc / Disque

CV3 000 11

305501 370x5

| | |
|---|-----------|
|  Unit weight | |
|  color | ■ schwarz |
|  piece | 100 |
|  unit | Pal |
|  accessories | |







Scheibe

Disc / Disque

CV3 000 09

423574 405x4,5

| | |
|---|-----------|
|  Unit weight | |
|  color | ■ schwarz |
|  piece | 100 |
|  unit | Pal |
|  accessories | |







Scheibe

Disc / Disque

CV3 000 09

444568 405x4,5

| | |
|---|-----------|
|  Unit weight | |
|  color | ■ schwarz |
|  piece | 100 |
|  unit | Pal |
|  accessories | |







Scheibe

Disc / Disque

CV3 000 18

444687 430 x 5 gezackt

| | |
|---|-----------|
|  Unit weight | 0,00 |
|  color | ■ schwarz |
|  piece | |
|  unit | Pal |
|  accessories | |







Scheibe

Disc / Disque

CV3 000 10

451371 410x5

| | |
|---|-----------|
|  Unit weight | |
|  color | ■ schwarz |
|  piece | 100 |
|  unit | Pal |
|  accessories | |







Scheibe

Disc / Disque

CV3 000 09

451372 405x4,5

| | |
|---|-----------|
|  Unit weight | |
|  color | ■ schwarz |
|  piece | 100 |
|  unit | Pal |
|  accessories | |







Scheibe

Disc / Disque

CV3 000 11

451793 370x5

| | |
|---|-----------|
|  Unit weight | |
|  color | ■ schwarz |
|  piece | 100 |
|  unit | Pal |
|  accessories | |







Scheibe

Disc / Disque

CV3 000 18

459114 430 x 5 gezackt

| | |
|---|-----------|
|  Unit weight | 0,00 |
|  color | ■ schwarz |
|  piece | |
|  unit | Pal |
|  accessories | |



Teile passend zu
parts interchangeable
Pièces adaptables pour





VAEDERSTAD

Scheibe

Disc / Disque

CV3 000 18

459608 430 x 5 gezackt





| | |
|---|---|
|  Unit weight | 0,00 |
|  color |  schwarz |
|  piece unit | Pal |
|  accessories | |

Scheibe

Disc / Disque

CV3 000 12

466947 450x5

| | |
|---|--|
|  Unit weight | |
|  color |  schwarz |
|  piece unit | 100 Pal |
|  accessories | |





Teile passend zu
parts interchangeable
Pièces adaptables pour

Vogel & Noot

RA1 320 02

RA1 320 02

 Unit weight 0,20

 color

 piece unit

 accessories





R23 206 00

vorne zu TerraDisc pro

 Unit weight 10,29

 color ■ rot

 piece unit 50
Pal

 accessories

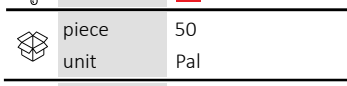

Abstreifer

Scraper /

KZ7 011 00

 Unit weight 3,83

 color

 piece unit

 accessories



Abstreifer

Scraper /

KZ7 009 00

 Unit weight 3,83

 color

 piece unit

 accessories





Abstreifer

Scraper /

317 897 4

100 Eurotil

 Unit weight 0,20

 color

 piece unit

 accessories





Abstreifer

Scraper /

KZ7 010 00

3-fach geschw.

 Unit weight 7,50

 color

 piece unit

 accessories





Abstreifer

Scraper /

KZ2 224 00

3M geschw

 Unit weight 87,88

 color

 piece unit

 accessories





Abstreifer

Scraper /

931 090 005

75x4x130

 Unit weight 0,30

 color

 piece unit

 accessories



Teile passend zu
parts interchangeable
Pièces adaptables pour

Vogel & Noot

Abstreifer Scraper /

KZ7 025 01

Abstreifer

Unit weight 0,33

color

piece unit

accessories



Abstreifer Scraper /

KZ7 062 01

Abstreifer

Unit weight 0,42

color

piece unit

accessories



LAGER BEARING /

RA1 332 00

M22x1,5 -4 hole-D98

Unit weight 2,80

color

piece unit

accessories



LAGER BEARING /

750 350

R2321800 6-Loch M24x2

Unit weight 2,40

color

piece unit

accessories



RING RING /

G03 757 02

G0375702 ZU KEILTROMMELWALZE

Unit weight 2,15

color roh

piece unit 200
unit Pal

accessories



Scheibe Disc / Disque

RA1 324 06

510 x 5MM GEZACKT

Unit weight 7,71

color schwarz

piece unit

accessories



Scheibe Disc / Disque

R23 204 02

GEZACKT 610MM TD PRO

Unit weight 12,45

color schwarz

piece unit

accessories

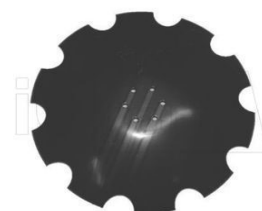

Scheibe Disc / Disque

R23 204 01

R2320401

Unit weight 7,08

color schwarz

piece unit

accessories









Teile passend zu
parts interchangeable
Pièces adaptables pour

Vogel & Noot

Scheibe
Disc / Disque





R23 204 03
R2320403 560x5 TERRADISC

| | |
|---|---|
|  Unit weight | 12,45 |
|  color |  schwarz |
|  piece unit | |
|  accessories | |



ZINKE
Tine leg /



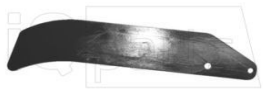

PQ7 340 03
PQ7 340 03

| | |
|---|--|
|  Unit weight | 2,00 |
|  color |  schwarz |
|  piece unit | Pal |
|  accessories | |



ZINKE
Tine leg /





RA1 350 04
Striegelzinke

| | |
|---|------|
|  Unit weight | 1,20 |
|  color | |
|  piece unit | |
|  accessories | |



ZINKE
Tine leg /

G05 790 02
Striegelzinke

| | |
|---|------|
|  Unit weight | 1,17 |
|  color | |
|  piece unit | |
|  accessories | |



SCHLEGELHÄCKSLER UND MULCHER

MULCHERS

DÉCHIQUETEUSES ET BROYEURS

ФРЕЗА И МУЛЬЧЕР

TRITURADORAS O PICADORAS

TRINCIATURA A MARTELLI E TRINCIA

MULCSOZÓ

ROZDRABNIACZE I MULCZERY

MALČER

MALČER

TOCĂTOARE ȘI MULCHER



Schlegelhäcksler und Mulcher

Mulcher / Déchiqueteuses et broyeurs

Teile passend zu
parts interchangeable
Pièces adaptables pour

VIGOLO

Flügel
Wing /

930 000 049

TST 40x8 F28,5

 Unit weight 0,52

 color

 piece unit

 accessories



HAMMER
HAMMER /

111 190 000

933 000 005

 Unit weight 1,68

 color

 piece unit

 accessories



HAMMER
HAMMER /

930 000 024

TSA EM06

 Unit weight 1,62

 color

 piece unit

 accessories



MESSER
KNIFE /

930 000 050

60x8x205

 Unit weight 0,68

 color

 piece unit

 accessories



MESSER
KNIFE /

930 000 029

TSA 50 x 8 Mustercut

 Unit weight 0,47

 color

 piece unit

 accessories



MESSER
KNIFE /

930 000 001

TST/TSL 60x8

 Unit weight 0,79

 color

 piece unit

 accessories



Schlegelhäcksler und Mulcher

Mulcher / Déchiqueteuses et broyeurs

Teile passend zu
parts interchangeable
Pièces adaptables pour

Vogel & Noot

Flügel
Wing /

930 000 049

TST 40x8 F28,5

 Unit weight 0,52

 color

 piece unit

 accessories



HAMMER
HAMMER /

111 190 000

933 000 005

 Unit weight 1,68

 color

 piece unit

 accessories



HAMMER
HAMMER /

930 000 024

TSA EM06

 Unit weight 1,62

 color

 piece unit

 accessories



MESSER
KNIFE /

930 000 050

60x8x205

 Unit weight 0,68

 color

 piece unit

 accessories



MESSER
KNIFE /

930 000 001

TST/TSL 60x8

 Unit weight 0,79

 color

 piece unit

 accessories



MESSER
KNIFE /

930 000 029

UNIVERSALM. TSA (50X8 BOHR.25)

 Unit weight 0,47

 color

 piece unit

 accessories



SCHRAUBEN

SCREW

VIS

БОЛТЫ

TORNILLOS

BULLONERIA

CSAVAROK

ŚRUBY

VIJCI

VIJAKI

SURUBURI



A SENKSCHRAUBE MIT 1 NASE DIN604

Angaben in mm

| Bez.: | M | L | K | B | Ø | Qualität | Art.Nr. iQ |
|--------|-----|----|----|-----|----|----------|------------|
| A-1640 | M16 | 40 | 10 | 4,2 | 32 | 8.8 | 548350V |
| A-1650 | M16 | 50 | 10 | 4,2 | 32 | 8.8 | 523865V |
| A-1660 | M16 | 60 | 10 | 4,2 | 32 | 8.8 | 545200V |
| A-1680 | M16 | 80 | 10 | 4,2 | 32 | 8.8 | |

C SENKSCHRAUBEN MIT 2 NASEN ISO5713

Angaben in mm

| Bez.: | M | L | K | B | Ø | Qualität | Art.Nr. iQ |
|--------|-----|----|-----|------|----|----------|------------|
| C-1030 | M10 | 30 | 4,5 | 15,1 | 16 | 8.8 | 545950V |
| C-1235 | M12 | 35 | 5,5 | 19,1 | 20 | 8.8 | 523997V |
| C-1435 | M14 | 35 | 7 | 23,1 | 24 | 8.8 | 546101V |

B SENKSCHRAUBE MIT VIERKANT DIN608

Angaben in mm

| Bez.: | M | L | K | B | Ø | Qualität | Art.Nr. iQ |
|---------|-----|-----|------|----|----|----------|------------|
| B-1025 | M10 | 25 | 8 | 10 | 19 | 12.9 | 547850V |
| B-1030 | M10 | 30 | 8 | 10 | 19 | 12.9 | 547900V |
| B-1035 | M10 | 35 | 8 | 10 | 19 | 12.9 | 547010V |
| B-1235 | M12 | 35 | 10,5 | 12 | 24 | 12.9 | 548000V |
| B-1240 | M12 | 40 | 10,5 | 12 | 24 | 12.9 | 548100V |
| B-1250 | M12 | 50 | 10,5 | 12 | 24 | 12.9 | 548195V |
| B-1255 | M12 | 55 | 10,5 | 12 | 24 | 12.9 | 548200V |
| B-1260 | M12 | 60 | 10,5 | 12 | 24 | 12.9 | 548250V |
| B-1270 | M12 | 70 | 10,5 | 12 | 24 | 12.9 | 548300V |
| B-1280 | M12 | 80 | 10,5 | 12 | 24 | 12.9 | 548305V |
| B-1285 | M12 | 85 | 10,5 | 12 | 24 | 12.9 | 548307V |
| B-1290 | M12 | 90 | 10,5 | 12 | 24 | 12.9 | 548310V |
| B-12120 | M12 | 120 | 10,5 | 12 | 24 | 12.9 | 548320V |
| B-12140 | M12 | 140 | 10,5 | 12 | 24 | 12.9 | 548330V |
| B-1440 | M14 | 40 | 11 | 14 | 28 | 10.9 | 549400V |
| B-1450 | M14 | 50 | 11 | 14 | 28 | 10.9 | 549500V |

D SENKSCHRAUBEN MIT 2 NASEN DIN11014

Angaben in mm

| Bez.: | M | L | K | B | Ø | Qualität | Art.Nr. iQ |
|--------|-----|----|-----|-----|----|----------|------------|
| D-1030 | M10 | 30 | 6 | 3,2 | 19 | 10.9 | 523742V |
| D-1035 | M10 | 35 | 6 | 3,2 | 19 | 10.9 | 523801V |
| D-1040 | M10 | 40 | 6 | 3,2 | 19 | 10.9 | 545955V |
| D-1230 | M12 | 30 | 7,5 | 3,6 | 24 | 12.9 | 546000V |
| D-1235 | M12 | 35 | 7,5 | 3,6 | 24 | 12.9 | 546100V |
| D-1240 | M12 | 40 | 7,5 | 3,6 | 24 | 10.9 | 546200V |
| D-1245 | M12 | 45 | 7,5 | 3,6 | 24 | 12.9 | 546400V |
| D-1250 | M12 | 50 | 7,5 | 3,6 | 24 | 10.9 | 546500V |
| D-1270 | M12 | 70 | 7,5 | 3,6 | 24 | 12.9 | 546750V |
| D-1270 | M12 | 70 | 7,5 | 3,6 | 24 | 12.9 | 546750V |
| D-1285 | M12 | 85 | 7,5 | 3,6 | 24 | 12.9 | 546850V |
| D-1445 | M14 | 45 | 9,5 | 4 | 28 | 12.9 | 546950V |
| D-1640 | M16 | 40 | 10 | 4,2 | 32 | 10.9 | 548351V |
| D-1650 | M16 | 50 | 10 | 4,2 | 32 | 10.9 | 548352V |

E SENKSCHAUBEN MIT 2 NASEN PASSEND ZU NAUD

Angaben in mm

| Bez.: | M | L | K | B | Ø | Qualität | Art.Nr. iQ |
|--------|---------|----|---|------|----|----------|------------|
| E-1430 | M14x1,5 | 30 | 7 | 21,6 | 22 | 8.8 | 546601V |
| E-1440 | M14x1,5 | 40 | 7 | 21,6 | 22 | 8.8 | 546602V |

F KONUSSCHRAUBE

Angaben in mm

| Bez.: | M | L | K | B | Ø | Qualität | Art.Nr. iQ |
|--------|-----|----|----|------|------|------------|------------|
| F-1434 | M14 | 34 | 7 | 17 | 18 | 12.9 | 523999V |
| F-1434 | M14 | 34 | 7 | 17 | 18 | 12.9 / S19 | 524000V |
| F-1640 | M16 | 40 | 10 | 19,4 | 20,8 | 12.9 | 523729V |

G KONUSSCHRAUBE FÜR MEISSEL

Angaben in mm

| Bez.: | M | L | K | B | Ø | Qualität | Art.Nr. iQ |
|--------|-----|----|---|------|----|----------|------------|
| G-1234 | M12 | 34 | 7 | 13,6 | 16 | 12.9 | 523998V |
| G-1240 | M12 | 40 | 7 | 13,6 | 16 | 12.9 | 523732V |
| G-1250 | M12 | 50 | 7 | 13,6 | 16 | 12.9 | 523732AV |

H KONUSSCHRAUBE PASSEND ZU VN

Angaben in mm

| Bez.: | M | L | K | B | Ø | Qualität | Art.Nr. iQ |
|--------|-----|----|---|------|----|----------|------------|
| H-1240 | M12 | 40 | 9 | 13,4 | 18 | 12.9 | LK100009V |
| H-1439 | M14 | 39 | 9 | 14,4 | 19 | 12.9 | LK000009V |

I KONUSSCHRAUBE

Angaben in mm

| Bez.: | M | L | K | B | Ø | Qualität | Art.Nr. iQ |
|--------|---------|----|---|------|------|----------|------------|
| I-1675 | M16x1,5 | 75 | 8 | 19,4 | 20,8 | 12.9 | 523724V |

J KONUSSCHRAUBE

Angaben in mm

| Bez.: | M | L | K | B | Ø | Qualität | Art.Nr. iQ |
|--------|-----|----|---|------|----|----------|------------|
| J-1025 | M10 | 25 | 7 | 13,6 | 16 | 12.9 | 523721V |
| J-1035 | M10 | 35 | 7 | 13,6 | 16 | 12.9 | 523725V |
| J-1040 | M10 | 40 | 7 | 13,6 | 16 | 12.9 | 523731V |

(K) SECHSKANTSCHRAUBE DIN931

Angaben in mm

| Bez.: | M | L | K | B | Ø | Qualität | Art.Nr. iQ |
|--------|-----|----|----|----|---|----------|------------|
| K-1260 | M12 | 60 | 10 | 24 | | 12.9 | 582700V |
| K-1665 | M16 | 65 | 10 | 24 | | 10.9 | 523782AV |
| K-1672 | M16 | 72 | 10 | 24 | | 10.9 | 523786V |
| K-2070 | M20 | 70 | 13 | 30 | | 8.8 | 580300V |

(L) SECHSKANTSCHRAUBE DIN960

Angaben in mm

| Bez.: | M | L | K | B | Ø | Qualität | Art.Nr. iQ |
|--------|---------|----|----|----|---|----------|------------|
| L-1665 | M16x1,5 | 65 | 10 | 24 | | 10.9 | 611600V |
| | | | | | | | |
| | | | | | | | |
| | | | | | | | |

(M) SENKSCHRAUBEN MIT 2 NASEN ZU NIEMEYER

Angaben in mm

| Bez.: | M | L | K | B | Ø | Qualität | Art.Nr. iQ |
|--------|-----|----|-----|------|----|----------|------------|
| M-1235 | M12 | 35 | 6,5 | 19,4 | 20 | 8.8 | 502511NV |
| M-1240 | M12 | 40 | 6,5 | 19,4 | 20 | 8.8 | 502512NV |

(Q) SENKSCHRAUBEN

Angaben in mm

| Bez.: | M | L | K | B | Ø | Qualität | Art.Nr. iQ |
|--------|-----|----|-----|---|------|----------|------------|
| Q-0833 | M8 | 33 | 6,5 | | 16 | 8.8 | 551001V |
| Q-1060 | M10 | 60 | 8 | | 18,5 | 10.9 | 551002V |
| Q-1260 | M12 | 60 | 9 | | 23 | 8.8 | 551003V |

(O) KONUSSCHRAUBE FÜR MEISSEL NIEMEYER, RABE

Angaben in mm

| Bez.: | M | L | K | B | Ø | Qualität | Art.Nr. iQ |
|--------|-----|----|-----|----|----|----------|------------|
| O-1235 | M12 | 35 | 8,5 | 14 | 18 | 12.9 | 501000V |

(P) VIERKANTSCHR. DIN603 LEMKEN SMARAGD

Angaben in mm

| Bez.: | M | L | K | B | Ø | Qualität | Art.Nr. iQ |
|--------|-----|----|------|------|------|----------|------------|
| P-1230 | M12 | 30 | 7,25 | 11,3 | 29,4 | 10.9 | 501001V |
| P-1235 | M12 | 35 | 7,25 | 11,3 | 29,4 | 10.9 | 501002V |

(R) HAMMERKOPFSCHRAUBE

Angaben in mm

| Bez.: | M | L | K | B | H | Qualität | Art.Nr. iQ |
|--------|-----|----|---|----|------|----------|------------|
| R-1060 | M10 | 60 | 7 | 14 | 16,8 | 10.9 | 551004V |

(S) SPANNSTIFT DIN1481 (ISO8752)

Angaben in mm

| Bez.: | D | L | A | S | D2 | Art.Nr. iQ |
|--------|------|----|---|-----|------|------------|
| S-0860 | 8,8 | 60 | 2 | 1,5 | 5,5 | 715701V |
| S-1060 | 10,8 | 60 | 2 | 2 | 6,5 | 716600V |
| S-1460 | 14,8 | 60 | 2 | 3 | 8,5 | 715700V |
| S-1660 | 16,8 | 60 | 2 | 3 | 10,5 | GOU16000 |

(T) Senkschraube mit Innensechskant

Angaben in mm

| Bez.: | M | L | K | D | Qualität | # |
|--------|-----|----|---|---|----------|----------|
| T-1440 | M14 | 40 | | | 10.9 | VIS14052 |

Teile passend zu
parts interchangeable
Pièces adaptables pour

Kverneland

Schraube
Screw / Boulon

**Senkschr. mit
MU; VE 50**

545 950 V

C-1030

10.9

Unit weight 0,03

color roh

piece 50
unit Kart

accessories



Schraube
Screw / Boulon

**Senkschr.mit
MU; VE 50**

523 997 V

C-1235

8.8

Unit weight 0,05

color roh

piece 50
unit Kart

accessories



Schraube
Screw / Boulon

**Konusschr
m.MU; VE 50**

523 999 V

F-1434

12.9

Unit weight 0,06

color roh

piece 50
unit Kart

accessories



Schraube
Screw / Boulon

**Konusschr mit
MU; VE 50**

523 998 V

G-1234

12.9

Unit weight 0,05

color roh

piece 50
unit Kart

accessories



Teile passend zu
parts interchangeable
Pièces adaptables pour

Lemken

Schraube
Screw / Boulon

547 010 V

B-1035 - 3015767

12.9

Unit weight 0,03

color roh

piece 50
unit Kart

accessories



Schraube
Screw / Boulon

548 000 V

B-1235 - 3015785

12.9

Unit weight 0,06

color roh

piece 50
unit Kart

accessories



Schraube
Screw / Boulon

**Vierkantschr.
mit MU; VE 50**

501 001 V

P-1230 M12x30 Mu

10.9

Unit weight 0,06

color roh

piece 50
unit Kart

accessories



Schraube
Screw / Boulon

501 002 V

P-1235 M12x35 Mu

10.9

Unit weight 0,04

color roh

piece 50
unit Kart

accessories



Teile passend zu
parts interchangeable
Pièces adaptables pour

Naud

Schraube
Screw / Boulon

**Senkschr. mit
MU; VE 50**

523 997 V

C-1235 8.8

Unit weight 0,05

color roh

piece 50
unit Kart

accessories



Schraube
Screw / Boulon

**Senkschr. mit
MU; VE 50**

546 601 V

E-1430 8.8

Unit weight 0,06

color roh

piece 50
unit Kart

accessories



Schraube
Screw / Boulon

546 602 V

E-1440 8.8

Unit weight 0,07

color roh

piece 50
unit Kart

accessories



Teile passend zu
parts interchangeable
Pièces adaptables pour

Niemeyer

Schraube
Screw / Boulon

**Senkschr.
m.MU; VE 50**

502 511 NV

M-1235 PR900002 M12x35 Mu 8.8

Unit weight 0,04

color roh

piece 50
unit Kart

accessories



Teile passend zu
parts interchangeable
Pièces adaptables pour

Pöttinger Landsberg

Schraube
Screw / Boulon

546 000 V

D-1230 105911

12.9

| | |
|-------------|------------------------------|
| Unit weight | 0,03 |
| color | <input type="checkbox"/> roh |
| piece unit | 50 Kart |
| accessories | |



Schraube
Screw / Boulon

546 100 V

D-1235 105912

12,9

| | |
|-------------|------------------------------|
| Unit weight | 0,04 |
| color | <input type="checkbox"/> roh |
| piece unit | 50 Kart |
| accessories | |



Schraube
Screw / Boulon

546 200 V

D-1240 105913

10.9

| | |
|-------------|------------------------------|
| Unit weight | 0,04 |
| color | <input type="checkbox"/> roh |
| piece unit | 50 Kart |
| accessories | |



Schraube
Screw / Boulon

546 400 V

D-1245 105914

| | |
|-------------|------------------------------|
| Unit weight | 0,05 |
| color | <input type="checkbox"/> roh |
| piece unit | 50 Kart |
| accessories | |



Schraube
Screw / Boulon

523 732 V

G-1240 109933

12.9

| | |
|-------------|------------------------------|
| Unit weight | 0,03 |
| color | <input type="checkbox"/> roh |
| piece unit | 50 Kart |
| accessories | |



Schraube
Screw / Boulon

523 732 AV

G-1250 109947

12.9

| | |
|-------------|------------------------------|
| Unit weight | 0,04 |
| color | <input type="checkbox"/> roh |
| piece unit | 50 Kart |
| accessories | |



Teile passend zu
parts interchangeable
Pièces adaptables pour

RABE

Schraube
Screw / Boulon

545 200 V

A-1660 604D1660P

8.8

| | | |
|--|-------------|------------------------------|
| | Unit weight | 0,04 |
| | color | <input type="checkbox"/> roh |
| | piece unit | 50 Kart |
| | accessories | |



Schraube
Screw / Boulon

547 900 V

B-1030 608D1030N

12.9

| | | |
|--|-------------|------------------------------|
| | Unit weight | 0,02 |
| | color | <input type="checkbox"/> roh |
| | piece unit | 50 Kart |
| | accessories | |



Schraube
Screw / Boulon

547 010 V

B-1035 608D1035N

12.9

| | | |
|--|-------------|------------------------------|
| | Unit weight | 0,03 |
| | color | <input type="checkbox"/> roh |
| | piece unit | 50 Kart |
| | accessories | |



Schraube
Screw / Boulon

548 000 V

B-1235-27002605 DIN608 M12x35N 12.9

| | | |
|--|-------------|------------------------------|
| | Unit weight | 0,06 |
| | color | <input type="checkbox"/> roh |
| | piece unit | 50 Kart |
| | accessories | |



Schraube
Screw / Boulon

548 100 V

B-1240 2700 2607

12.9

| | | |
|--|-------------|------------------------------|
| | Unit weight | 0,06 |
| | color | <input type="checkbox"/> roh |
| | piece unit | 50 Kart |
| | accessories | |



Schraube
Screw / Boulon

548 300 V

B-1270 2700 2613

12.9

| | | |
|--|-------------|------------------------------|
| | Unit weight | 0,06 |
| | color | <input type="checkbox"/> roh |
| | piece unit | 50 Kart |
| | accessories | |



Schraube
Screw / Boulon

546 000 V

D-1230 11014D1230N

12.9

| | | |
|--|-------------|------------------------------|
| | Unit weight | 0,03 |
| | color | <input type="checkbox"/> roh |
| | piece unit | 50 Kart |
| | accessories | |



Schraube
Screw / Boulon

546 100 V

D-1235 11014D1235N

12.9

| | | |
|--|-------------|------------------------------|
| | Unit weight | 0,04 |
| | color | <input type="checkbox"/> roh |
| | piece unit | 50 Kart |
| | accessories | |



Teile passend zu
parts interchangeable
Pièces adaptables pour

RABE

Schraube
Screw / Boulon

523 786 V

K-1672 931D167P

10.9

Unit weight 0,15

color roh

piece 50
unit Kart

accessories



Schraube
Screw / Boulon

611 600 V

L-1665 960D161565N

10.9

Unit weight 0,13

color roh

piece 50
unit Kart

accessories



Schraube
Screw / Boulon

502 511 NV

M-1235 PR900002 M12x35 Mu

8.8

Unit weight 0,04

color roh

piece 50
unit Kart

accessories



Schraube
Screw / Boulon

**Konusschr
m.Mu; VE 50**

501 000 V

O-1235 27004113 M12x35 Mu

12.9

Unit weight 0,05

color roh

piece 50
unit Kart

accessories



Spannstift

Spring / Goupille élastique

716 600 V

S-1060 1481D1060A

Unit weight 0,01

color roh

piece 50
unit Kart

accessories



Spannstift

Spring / Goupille élastique

GOU 160 00

S-1660 1481D1660A

Unit weight 0,05

color roh

piece 50
unit Kart

accessories



Teile passend zu
parts interchangeable
Pièces adaptables pour

Schrauben

Gummibeilage

Rubber - Insert / Caoutchouc - Intermede

663 585

663585 824820

| | |
|-------------|--|
| Unit weight | 0,01 |
| color | schwarz |
| piece unit | 1 000 Kart |
| accessories | |



Schraube

Screw / Boulon

548 350 V

A-1640

8.8

| | |
|-------------|---|
| Unit weight | 0,11 |
| color | roh |
| piece unit | 50 Kart |
| accessories | |



Schraube

Screw / Boulon

523 865 V

A-1650-M16 x 50 mit shaft

10.9

| | |
|-------------|---|
| Unit weight | 0,08 |
| color | roh |
| piece unit | 50 Kart |
| accessories | |



Schraube

Screw / Boulon

545 200 V

A-1660

8.8

| | |
|-------------|---|
| Unit weight | 0,04 |
| color | roh |
| piece unit | 50 Kart |
| accessories | |



Schraube

Screw / Boulon

547 850 V

B-1025 DIN608-12.9 M10x25Mu

| | |
|-------------|---|
| Unit weight | 0,02 |
| color | roh |
| piece unit | 50 Kart |
| accessories | |



Schraube

Screw / Boulon

547 900 V

B-1030

12.9

| | |
|-------------|---|
| Unit weight | 0,02 |
| color | roh |
| piece unit | 50 Kart |
| accessories | |



Schraube

Screw / Boulon

547 010 V

B-1035

12.9

| | |
|-------------|---|
| Unit weight | 0,03 |
| color | roh |
| piece unit | 50 Kart |
| accessories | |



**Senkschr. mit
MU; VE 50**

Schraube

Screw / Boulon

548 320 V

B-12120

12.9

| | |
|-------------|---|
| Unit weight | 0,07 |
| color | roh |
| piece unit | 50 Kart |
| accessories | |



Teile passend zu
parts interchangeable
Pièces adaptables pour

Schrauben

Schraube
Screw / Boulon

**Senkschr. mit
MU; VE 50**

548 000 V

B-1235 12.9

| | |
|-------------|------------------------------|
| Unit weight | 0,06 |
| color | <input type="checkbox"/> roh |
| piece unit | 50 Kart |
| accessories | |



Schraube
Screw / Boulon

**Senkschr. mit
MU; VE 50**

548 100 V

B-1240 12.9

| | |
|-------------|------------------------------|
| Unit weight | 0,06 |
| color | <input type="checkbox"/> roh |
| piece unit | 50 Kart |
| accessories | |



Schraube
Screw / Boulon

548 190 V

B-1245 M12x45 DIN 608 Mu 12.9

| | |
|-------------|------------------------------|
| Unit weight | 0,06 |
| color | <input type="checkbox"/> roh |
| piece unit | 50 Kart |
| accessories | |



Schraube
Screw / Boulon

548 195 V

B-1250 M12x50 DIN 608

| | |
|-------------|------------------------------|
| Unit weight | 0,05 |
| color | <input type="checkbox"/> roh |
| piece unit | 50 Kart |
| accessories | |



Schraube
Screw / Boulon

548 200 V

B-1255 M12x55 MU DIN608

| | |
|-------------|------------------------------|
| Unit weight | 0,05 |
| color | <input type="checkbox"/> roh |
| piece unit | 50 Kart |
| accessories | |



Schraube
Screw / Boulon

**Senkschr.
m.MU; VE 50**

548 250 V

B-1260 12.9

| | |
|-------------|------------------------------|
| Unit weight | 0,06 |
| color | <input type="checkbox"/> roh |
| piece unit | 50 Kart |
| accessories | |



Schraube
Screw / Boulon

**Senkschr.
m.MU; VE 50**

548 300 V

B-1270 12.9

| | |
|-------------|------------------------------|
| Unit weight | 0,06 |
| color | <input type="checkbox"/> roh |
| piece unit | 50 Kart |
| accessories | |



Schraube
Screw / Boulon

**Senkschr.m.M
U; VE 50**

548 305 V

B-1280 12.9

| | |
|-------------|------------------------------|
| Unit weight | 0,07 |
| color | <input type="checkbox"/> roh |
| piece unit | 50 Kart |
| accessories | |



Teile passend zu
parts interchangeable
Pièces adaptables pour

Schrauben

Schraube
Screw / Boulon

548 307 V

B-1285

| | |
|-------------|------------------------------|
| Unit weight | 0,09 |
| color | <input type="checkbox"/> roh |
| piece unit | 50 Kart |
| accessories | |



Schraube
Screw / Boulon

548 310 V

B-1290

| | |
|-------------|------------------------------|
| Unit weight | 0,07 |
| color | <input type="checkbox"/> roh |
| piece unit | 50 Kart |
| accessories | |



Schraube
Screw / Boulon

549 400 V

B-1440

10.9

| | |
|-------------|------------------------------|
| Unit weight | 0,00 |
| color | <input type="checkbox"/> roh |
| piece unit | 50 Kart |
| accessories | |



Schraube
Screw / Boulon

549 500 V

B-1450

10.9

| | |
|-------------|------------------------------|
| Unit weight | 0,00 |
| color | <input type="checkbox"/> roh |
| piece unit | 50 Kart |
| accessories | |



Schraube
Screw / Boulon

**Senkschr.mit
MU; VE 50**

523 997 V

C-1235

8.8

| | |
|-------------|------------------------------|
| Unit weight | 0,05 |
| color | <input type="checkbox"/> roh |
| piece unit | 50 Kart |
| accessories | |



Schraube
Screw / Boulon

**Senkschr. mit
MU; VE 50**

546 101 V

C-1435

8.8

| | |
|-------------|------------------------------|
| Unit weight | 0,07 |
| color | <input type="checkbox"/> roh |
| piece unit | 50 Kart |
| accessories | |



Schraube
Screw / Boulon

**Senkschr.m.M
U; VE 50**

523 742 V

D-1030

10.9

| | |
|-------------|------------------------------|
| Unit weight | 0,02 |
| color | <input type="checkbox"/> roh |
| piece unit | 50 Kart |
| accessories | |



Schraube
Screw / Boulon

**Senkschr.m.M
U; VE 50**

523 801 V

D-1035

10.9

| | |
|-------------|------------------------------|
| Unit weight | 0,03 |
| color | <input type="checkbox"/> roh |
| piece unit | 50 Kart |
| accessories | |



Teile passend zu
parts interchangeable
Pièces adaptables pour

Schrauben

Schraube
Screw / Boulon

545 955 V

D-1040

10.9

| | |
|-------------|------------------------------|
| Unit weight | 0,03 |
| color | <input type="checkbox"/> roh |
| piece unit | 50 Kart |
| accessories | |



Schraube
Screw / Boulon

546 000 V

D-1230

12.9

| | |
|-------------|------------------------------|
| Unit weight | 0,03 |
| color | <input type="checkbox"/> roh |
| piece unit | 50 Kart |
| accessories | |



Schraube
Screw / Boulon

Senkschr.m.M
U; VE 50

546 100 V

D-1235

12,9

| | |
|-------------|------------------------------|
| Unit weight | 0,04 |
| color | <input type="checkbox"/> roh |
| piece unit | 50 Kart |
| accessories | |



Schraube
Screw / Boulon

Senkschr.m.M
U; VE 50

546 200 V

D-1240

10.9

| | |
|-------------|------------------------------|
| Unit weight | 0,04 |
| color | <input type="checkbox"/> roh |
| piece unit | 50 Kart |
| accessories | |



Schraube
Screw / Boulon

546 400 V

D-1245

| | |
|-------------|------------------------------|
| Unit weight | 0,05 |
| color | <input type="checkbox"/> roh |
| piece unit | 50 Kart |
| accessories | |



Schraube
Screw / Boulon

Senkschr.
m.MU

546 500 V

D-1250

10.9

| | |
|-------------|------------------------------|
| Unit weight | 0,05 |
| color | <input type="checkbox"/> roh |
| piece unit | 50 Kart |
| accessories | |



Schraube
Screw / Boulon

546 750 V

D-1270

10.9

| | |
|-------------|------------------------------|
| Unit weight | 0,05 |
| color | <input type="checkbox"/> roh |
| piece unit | 50 Kart |
| accessories | |



Schraube
Screw / Boulon

546 850 V

D-1285

10.9

| | |
|-------------|------------------------------|
| Unit weight | 0,05 |
| color | <input type="checkbox"/> roh |
| piece unit | 50 Kart |
| accessories | |



Teile passend zu
parts interchangeable
Pièces adaptables pour

Schrauben

| Schraube Screw / Boulon | |
|----------------------------|------------------------------|
| 546 950 V | 12.9 |
| <i>D-1435</i> | |
| Unit weight | 0,05 |
| color | <input type="checkbox"/> roh |
| piece | 50 |
| unit | Kart |
| accessories | |

| Schraube Screw / Boulon | |
|----------------------------|------------------------------|
| 548 351 V | 10,9 |
| <i>D-1640</i> | |
| Unit weight | 0,08 |
| color | <input type="checkbox"/> roh |
| piece | 50 |
| unit | Kart |
| accessories | |



| Schraube Screw / Boulon | |
|----------------------------|------------------------------|
| 546 601 V | 8.8 |
| <i>E-1430</i> | |
| Unit weight | 0,06 |
| color | <input type="checkbox"/> roh |
| piece | 50 |
| unit | Kart |
| accessories | |



| Schraube Screw / Boulon | | Senkschr. mit MU; VE 50 |
|----------------------------|------------------------------|----------------------------|
| 546 602 V | 8.8 | |
| <i>E-1440</i> | | |
| Unit weight | 0,07 | |
| color | <input type="checkbox"/> roh | |
| piece | 50 | |
| unit | Kart | |
| accessories | | |



| Schraube Screw / Boulon | | Konusschr m.MU; VE 50 |
|----------------------------|------------------------------|--------------------------|
| 523 999 V | 12.9 | |
| <i>F-1434</i> | | |
| Unit weight | 0,06 | |
| color | <input type="checkbox"/> roh | |
| piece | 50 | |
| unit | Kart | |
| accessories | | |



| Schraube Screw / Boulon | |
|----------------------------|------------------------------|
| 523 998 V | 12.9 |
| <i>G-1234</i> | |
| Unit weight | 0,05 |
| color | <input type="checkbox"/> roh |
| piece | 50 |
| unit | Kart |
| accessories | |



| Schraube Screw / Boulon | | Konuschr.m.M U; VE 50 |
|----------------------------|------------------------------|--------------------------|
| 523 732 V | 12.9 | |
| <i>G-1240</i> | | |
| Unit weight | 0,03 | |
| color | <input type="checkbox"/> roh | |
| piece | 50 | |
| unit | Kart | |
| accessories | | |



| Schraube Screw / Boulon | | Konusschr.m. MU; VE 50 |
|----------------------------|------------------------------|---------------------------|
| 523 732 AV | 12.9 | |
| <i>G-1250</i> | | |
| Unit weight | 0,04 | |
| color | <input type="checkbox"/> roh | |
| piece | 50 | |
| unit | Kart | |
| accessories | | |



Teile passend zu
parts interchangeable
Pièces adaptables pour

Schrauben

Schraube
Screw / Boulon

523 733 E

G-1439 M14x39Mu

| | | |
|--|-------------|------|
| | Unit weight | 0,04 |
| | color | |
| | piece unit | |
| | accessories | |



Schraube
Screw / Boulon

LK1 000 09V

H-1240

12.9

| | | |
|--|-------------|------------|
| | Unit weight | 0,04 |
| | color | |
| | piece unit | 50 Kart |
| | accessories | |



Schraube
Screw / Boulon

LK0 000 09V

H-1439

12.9

| | | |
|--|-------------|------------|
| | Unit weight | 0,04 |
| | color | |
| | piece unit | 50 Kart |
| | accessories | |



Schraube
Screw / Boulon

LK0 000 10V

H-1448 M14x48-12.9 Mu

| | | |
|--|-------------|------|
| | Unit weight | 0,06 |
| | color | |
| | piece unit | |
| | accessories | |



Schraube
Screw / Boulon

Konus-Schr.m.
MU; VE 50

523 724 V

I-1675 PK800010 M16x1,5x75 Mu 12.9

| | | |
|--|-------------|------------------------------|
| | Unit weight | 0,12 |
| | color | <input type="checkbox"/> roh |
| | piece unit | 50 Kart |
| | accessories | |



Schraube
Screw / Boulon

Konusschr.m.
MU; VE 50

523 721 V

J-1025 PK000011 M10x25 Mu 12.9

| | | |
|--|-------------|------------------------------|
| | Unit weight | 0,02 |
| | color | <input type="checkbox"/> roh |
| | piece unit | 50 Kart |
| | accessories | |



Schraube
Screw / Boulon

523 725 V

J-1035 M10x35 Mu

12.9

| | | |
|--|-------------|------------------------------|
| | Unit weight | 0,03 |
| | color | <input type="checkbox"/> roh |
| | piece unit | 50 Kart |
| | accessories | |



Schraube
Screw / Boulon

523 731 V

J-1040 M10x40 Mu

12.9

| | | |
|--|-------------|------------------------------|
| | Unit weight | 0,03 |
| | color | <input type="checkbox"/> roh |
| | piece unit | 50 Kart |
| | accessories | |



Teile passend zu
parts interchangeable
Pièces adaptables pour

Schrauben

Schraube
Screw / Boulon

582 700 V

K-1260 DIN 931-12.9 M12x60Mu

| | | |
|--|-------------|------------------------------|
| | Unit weight | 0,06 |
| | color | <input type="checkbox"/> roh |
| | piece unit | 50 Kart |
| | accessories | |



Schraube
Screw / Boulon

582 788 V

K-1475 M14x75 DIN 931 Mu 10.9

| | | |
|--|-------------|------------------------------|
| | Unit weight | 0,12 |
| | color | <input type="checkbox"/> roh |
| | piece unit | 50 Kart |
| | accessories | |



Schraube
Screw / Boulon

523 782 AV

K-1665 10.9

| | | |
|--|-------------|------------------------------|
| | Unit weight | 0,13 |
| | color | <input type="checkbox"/> roh |
| | piece unit | 50 Kart |
| | accessories | |



Schraube
Screw / Boulon

611 600 V

L-1665 10.9

| | | |
|--|-------------|------------------------------|
| | Unit weight | 0,13 |
| | color | <input type="checkbox"/> roh |
| | piece unit | 50 Kart |
| | accessories | |



Schraube
Screw / Boulon

Senkschr.m.M
U; VE 50

502 511 NV

M-1235 PR900002 M12x35 Mu 8.8

| | | |
|--|-------------|------------------------------|
| | Unit weight | 0,04 |
| | color | <input type="checkbox"/> roh |
| | piece unit | 50 Kart |
| | accessories | |



Schraube
Screw / Boulon

Konuschr. mit
Mu; VE 50

501 000 V

O-1235 M12x35 Mu 12.9

| | | |
|--|-------------|------------------------------|
| | Unit weight | 0,05 |
| | color | <input type="checkbox"/> roh |
| | piece unit | 50 Kart |
| | accessories | |



Schraube
Screw / Boulon

501 004 V

O-1240 294503511 M12x40 Mu 12.9

| | | |
|--|-------------|------------------------------|
| | Unit weight | 0,05 |
| | color | <input type="checkbox"/> roh |
| | piece unit | 50 Kart |
| | accessories | |



Schraube
Screw / Boulon

Vierkantschr.
mit MU; VE 50

501 001 V

P-1230 M12x30 Mu 10.9

| | | |
|--|-------------|------------------------------|
| | Unit weight | 0,06 |
| | color | <input type="checkbox"/> roh |
| | piece unit | 50 Kart |
| | accessories | |



Teile passend zu
parts interchangeable
Pièces adaptables pour

Schrauben

Schraube

Screw / Boulon

551 002 V

Q-1060 M10x60-10.9 Mu

| | | |
|--|-------------|------------------------------|
| | Unit weight | 0,00 |
| | color | <input type="checkbox"/> roh |
| | piece unit | 50 Kart |
| | accessories | |



Schraube

Screw / Boulon

551 003 V

Q-1260 M12x60-8.8 Mu

| | | |
|--|-------------|------------------------------|
| | Unit weight | 0,00 |
| | color | <input type="checkbox"/> roh |
| | piece unit | 50 Kart |
| | accessories | |



Schraube

Screw / Boulon

551 004 V

R-1060 M10 x 60 Mu 10.9

| | | |
|--|-------------|------------------------------|
| | Unit weight | 0,00 |
| | color | <input type="checkbox"/> roh |
| | piece unit | 50 Kart |
| | accessories | |



Schraube

Screw / Boulon

551 004 V

R-1060 M10x60 Mu. 10.9

| | | |
|--|-------------|------------------------------|
| | Unit weight | 0,00 |
| | color | <input type="checkbox"/> roh |
| | piece unit | 50 Kart |
| | accessories | |



Schraube

Screw / Boulon

X48 450 01

R-1060 M10x60-10.9

| | | |
|--|-------------|------|
| | Unit weight | 0,04 |
| | color | |
| | piece unit | |
| | accessories | |



Schraube

Screw / Boulon

VIS 140 52

T-1440 M14 x x40 Mu 10.9

| | | |
|--|-------------|---------|
| | Unit weight | 0,05 |
| | color | |
| | piece unit | 50 Kart |
| | accessories | |



Schraube

Screw / Boulon

630 656 V

Y-1440 M14x40 DIN7991-8.8 Mu

| | | |
|--|-------------|------|
| | Unit weight | 0,10 |
| | color | |
| | piece unit | |
| | accessories | |



Spannstift

Spring / Goupille élastique

715 701 V

S-0860 8x60 DIN1481

| | | |
|--|-------------|------------------------------|
| | Unit weight | 0,01 |
| | color | <input type="checkbox"/> roh |
| | piece unit | 50 Kart |
| | accessories | |







Teile passend zu
parts interchangeable
Pièces adaptables pour

Schrauben

Spannstift
Spring / Goupille élastique

715 700 V

S-1460 14x60 DIN1481

| | | |
|---|-------------|------------|
|  | Unit weight | 0,02 |
|  | color | roh |
|  | piece unit | 50 Kart |
|  | accessories | |



Teile passend zu
parts interchangeable
Pièces adaptables pour

Vogel & Noot

| Schraube Screw / Boulon | Senkschr.m.M U; VE 50 |
|----------------------------|--------------------------|
| 523 801 V | |
| <i>D-1035</i> | 10.9 |

| | |
|-------------|------------------------------|
| Unit weight | 0,03 |
| color | <input type="checkbox"/> roh |
| piece unit | 50 Kart |
| accessories | |



| Schraube Screw / Boulon | Konusschr. |
|-------------------------------|------------|
| 523 729 V | |
| <i>F-1640 PK800013 M16x40</i> | 12.9 |

| | |
|-------------|------------------------------|
| Unit weight | 0,07 |
| color | <input type="checkbox"/> roh |
| piece unit | 50 Kart |
| accessories | |



| Schraube Screw / Boulon | Konusschr.m. MU; VE 50 |
|----------------------------|---------------------------|
| 523 732 V | |
| <i>G-1240</i> | 12.9 |

| | |
|-------------|------------------------------|
| Unit weight | 0,03 |
| color | <input type="checkbox"/> roh |
| piece unit | 50 Kart |
| accessories | |



| Schraube Screw / Boulon | Konusschr. m.MU; VE 50 |
|----------------------------|---------------------------|
| 523 732 AV | |
| <i>G-1250</i> | 12.9 |

| | |
|-------------|------------------------------|
| Unit weight | 0,04 |
| color | <input type="checkbox"/> roh |
| piece unit | 50 Kart |
| accessories | |



| Schraube Screw / Boulon | |
|----------------------------|--|
| 523 733 E | |
| <i>G-1439 M14x39Mu</i> | |

| | |
|-------------|------|
| Unit weight | 0,04 |
| color | |
| piece unit | |
| accessories | |



| Schraube Screw / Boulon | |
|----------------------------|------|
| LK1 000 09V | |
| <i>H-1240</i> | 12.9 |

| | |
|-------------|------------|
| Unit weight | 0,04 |
| color | |
| piece unit | 50 Kart |
| accessories | |



| Schraube Screw / Boulon | |
|----------------------------|------|
| LK0 000 09V | |
| <i>H-1439</i> | 12.9 |

| | |
|-------------|------------|
| Unit weight | 0,04 |
| color | |
| piece unit | 50 Kart |
| accessories | |



| Schraube Screw / Boulon | Konus-Schr.m. MU; VE 50 |
|--------------------------------------|----------------------------|
| 523 724 V | |
| <i>I-1675 PK800010 M16x1,5x75 Mu</i> | 12.9 |

| | |
|-------------|------------------------------|
| Unit weight | 0,12 |
| color | <input type="checkbox"/> roh |
| piece unit | 50 Kart |
| accessories | |



Teile passend zu
parts interchangeable
Pièces adaptables pour





Vogel & Noot

Schraube
Screw / Boulon

Konusschr.m.
MU; VE 50

523 721 V

J-1025 PK000011 M10x25 Mu 12.9

| | |
|---|------------------------------|
|  Unit weight | 0,02 |
|  color | <input type="checkbox"/> roh |
|  piece unit | 50 Kart |
|  accessories | |







Schraube
Screw / Boulon

Sechskantschr
aub

523 786 V

K-1672 10.9

| | |
|---|------------------------------|
|  Unit weight | 0,15 |
|  color | <input type="checkbox"/> roh |
|  piece unit | 50 Kart |
|  accessories | |







Schraube
Screw / Boulon

Senkschr.
m.MU; VE 50

502 511 NV

M-1235 PR900002 M12x35 Mu 8.8

| | |
|---|------------------------------|
|  Unit weight | 0,04 |
|  color | <input type="checkbox"/> roh |
|  piece unit | 50 Kart |
|  accessories | |







Schraube
Screw / Boulon

Senkschr.oh.M
U; VE 50

502 512 NV

M-1240 M12x40 8.8

| | |
|---|------------------------------|
|  Unit weight | 0,04 |
|  color | <input type="checkbox"/> roh |
|  piece unit | 50 Kart |
|  accessories | |



Logistic is more than transport

Produkte sind durch Fakten vergleichbar und durch Zahlen messbar. Ideen sind es nicht. Unser Ziel ist, nicht nur ein gutes Produkt zu verkaufen, sondern Ihnen auch mit Ideen den Verkauf und das Handling zu erleichtern.

Products can be compared on the basis of facts and measured using figures. They are not ideas. Our aim is not only to sell a good-quality product, but also to simplify the sales process and handling for you, by means of ideas.



Das ist „Premium-Logistik“ – vollautomatisch und fehlerfrei wiegen, zählen und etikettieren.

This is “Premium logistics” – the weighing, counting and labelling processes are fully-automated, eliminating errors.

iQparts

Ihre Artikelnummer in unserem System

- im Webshop für Sie zu finden
- mit Barcode auf der Ware

Your article number in our system

- You can find this in our Webshop
- with barcode on your goods



Sparen Sie sich das mühsame Suchen nach den passenden Schrauben für Ihren Verschleißteil. Wir erstellen Schraubensets genau zu den jeweiligen Teilen. Das heißt, Sie brauchen keine Durchmesser oder Spezifikationen von Gewinde oder Kopf angeben – lediglich die Teilenummer. Wir senden Ihnen dann die passenden Schrauben in definierten Packungsgrößen mit Ihrer Bestellung mit.

Smartes Service für

- vereinfachtes Bestellwesen
- gute Zusatzverkäufe
- lückenlose Lagerhaltung



Save yourself the effort of searching for the right bolts for your wearing part. We manufacture sets of bolts to fit the relevant parts precisely. This means you do not need to provide the diameter, thread specifications or bolt head size – simply the part number. We will then send you the correct bolts with your order, in predefined packaging sizes.

Smart service for

- simplified order process
- good opportunities for additional sales
- extensive storage

iQparts for all Brands interchangeable to ...



Beyne GmbH

Bundesstraße 8 | A - 8661 St. Barbara im Mürztal

Tel : +43 3858 6055 411 | Fax : +43 3858 6055 409

order@iqparts.com

www.iqparts.com